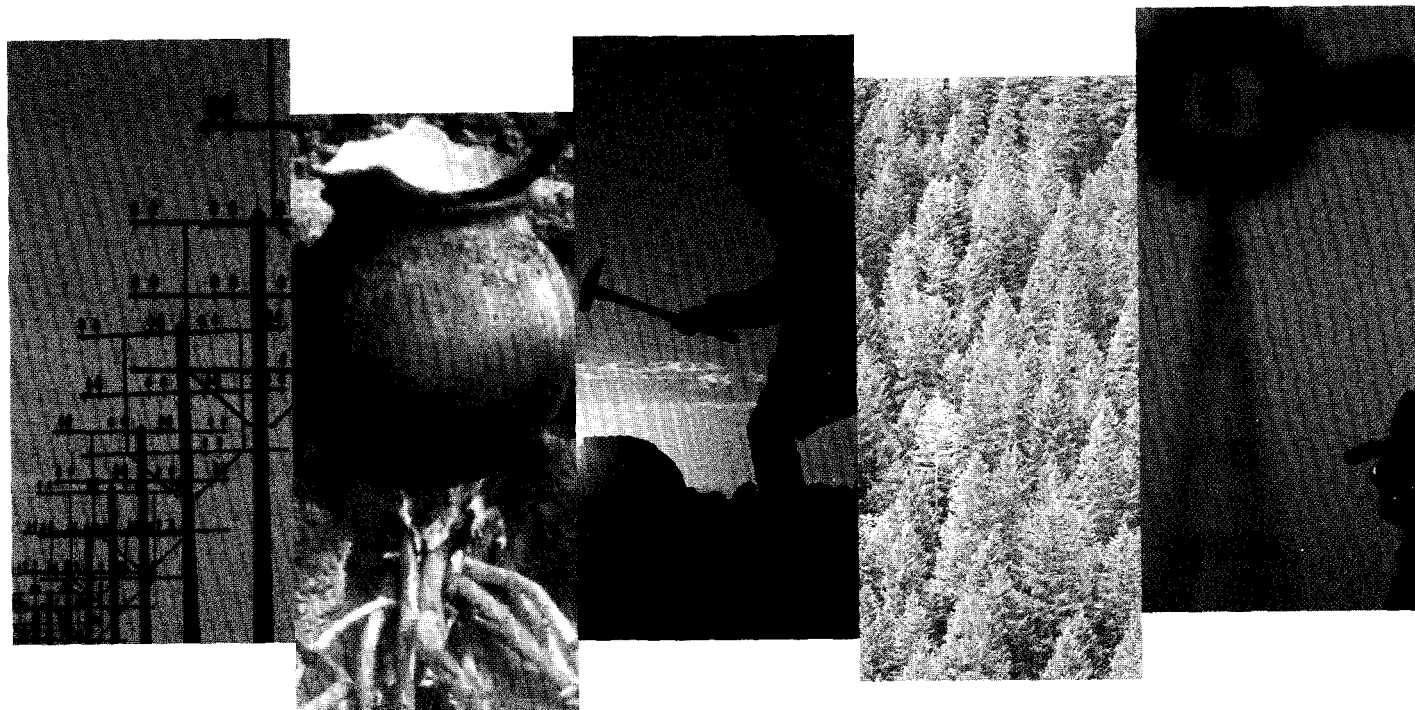


*Mini-Grid Design Manual*

21364



Energy

Sector

Management

Assistance

Programme

**FILE COPY**

September 2000



**Papers in the ESMAP Technical Series are discussion documents, not final project reports. They are subject to the same copyrights as other ESMAP publications.**

**JOINT UNDP / WORLD BANK  
ENERGY SECTOR MANAGEMENT ASSISTANCE PROGRAMME (ESMAP)**

**PURPOSE**

The Joint UNDP/World Bank Energy Sector Management Assistance Programme (ESMAP) is a special global technical assistance program run as part of the World Bank's Energy, Mining and Telecommunications Department. ESMAP provides advice to governments on sustainable energy development. Established with the support of UNDP and bilateral official donors in 1983, it focuses on the role of energy in the development process with the objective of contributing to poverty alleviation, improving living conditions and preserving the environment in developing countries and transition economies. ESMAP centers its interventions on three priority areas: sector reform and restructuring; access to modern energy for the poorest; and promotion of sustainable energy practices.

**GOVERNANCE AND OPERATIONS**

ESMAP is governed by a Consultative Group (ESMAP CG) composed of representatives of the UNDP and World Bank, other donors, and development experts from regions benefiting from ESMAP's assistance. The ESMAP CG is chaired by a World Bank Vice President, and advised by a Technical Advisory Group (TAG) of four independent energy experts that reviews the Programme's strategic agenda, its work plan, and its achievements. ESMAP relies on a cadre of engineers, energy planners, and economists from the World Bank to conduct its activities under the guidance of the Manager of ESMAP, responsible for administering the Programme.

**FUNDING**

ESMAP is a cooperative effort supported over the years by the World Bank, the UNDP and other United Nations agencies, the European Union, the Organization of American States (OAS), the Latin American Energy Organization (OLADE), and public and private donors from countries including Australia, Belgium, Canada, Denmark, Germany, Finland, France, Iceland, Ireland, Italy, Japan, the Netherlands, New Zealand, Norway, Portugal, Sweden, Switzerland, the United Kingdom, and the United States of America.

**FURTHER INFORMATION**

An up-to-date listing of completed ESMAP projects is appended to this report. For further information, a copy of the ESMAP Annual Report, or copies of project reports, contact:

**ESMAP**  
c/o Energy, Mining and Telecommunications Department  
The World Bank  
1818 H Street, NW  
Washington, DC 20433  
U.S.A.

# **Mini-Grid Design Manual**

---

**April 2000**

**Joint UNDP/World Bank Energy Sector Management Assistance Program  
(ESMAP)**

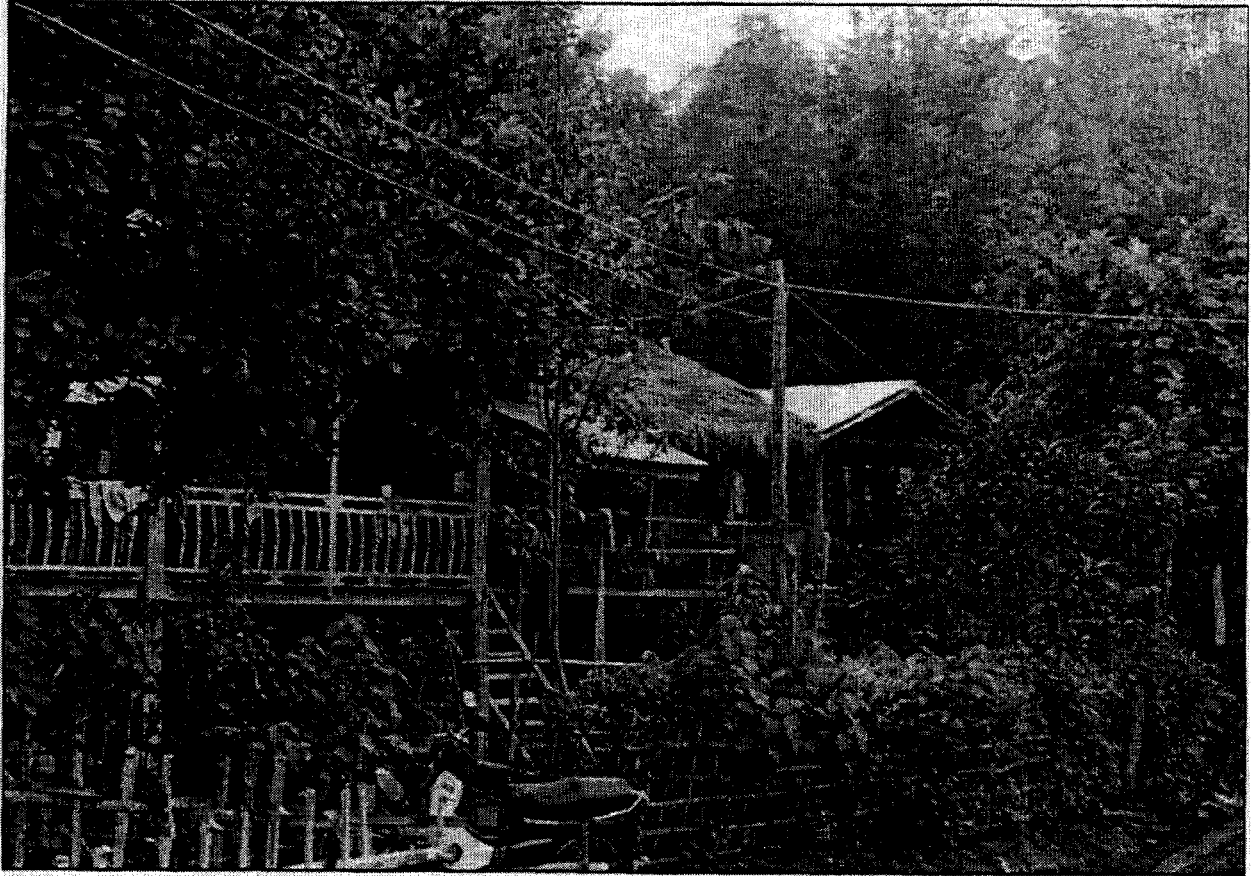
Copyright © 1999  
The International Bank for Reconstruction  
and Development/THE WORLD BANK  
1818 H Street, N.W.  
Washington, D.C. 20433, U.S.A.

All rights reserved  
Manufactured in the United States of America  
First printing September 2000

ESMAP Reports are published to communicate the results of the ESMAP's work to the development community with the least possible delay. The typescript of the paper therefore has not been prepared in accordance with the procedures appropriate to formal documents. Some sources cited in this paper may be informal documents that are not readily available.

The findings, interpretations, and conclusions expressed in this paper are entirely those of the author(s) and should not be attributed in any manner to the World Bank, or its affiliated organizations, or to members of its Board of Executive Directors or the countries they represent. The World Bank does not guarantee the accuracy of the data included in this publication and accepts no responsibility whatsoever for any consequence of their use. The Boundaries, colors, denominations, other information shown on any map in this volume do not imply on the part of the World Bank Group any judgement on the legal status of any territory or the endorsement or acceptance of such boundaries.

The material in this publication is copyrighted. Requests for permission to reproduce portions of it should be sent to the ESMAP Manager at the address shown in the copyright notice above. ESMAP encourages dissemination of its work and will normally give permission promptly and, when the reproduction is for noncommercial purposes, without asking a fee.



# **Mini-Grid Design Manual**



## Table of contents

<b>I. Introduction .....</b>	<b>1</b>
<b>II. Setting the context for low-cost mini-grids .....</b>	<b>5</b>
Ivory Coast .....	6
Laos .....	8
Irian Jaya .....	9
Dominican Republic .....	9
Conclusion .....	10
<b>III. Preconditions and action plan .....</b>	<b>12</b>
Willingness and ability to pay .....	12
Identification of a responsible individual/organization .....	15
Adequacy of electricity supply .....	16
Grid extension .....	16
Diesel/gasoline genset .....	17
Hydropower plant .....	18
Wind turbine .....	21
Solar PV station .....	22
Plan of action .....	23
<b>IV. Electricity uses and demand assessment .....</b>	<b>26</b>
Types of uses .....	26
Lighting .....	26
Entertainment .....	36
Motor-based applications .....	37
Heat-generating appliances .....	43
Demand assessment .....	44
Demand-side management .....	47
<b>V. Mapping and system layout .....</b>	<b>49</b>
Mapping .....	49
System layout .....	50
Powerhouse location .....	50
Placing the lines .....	51
Locating poles .....	53
<b>VI. Line configuration .....</b>	<b>54</b>
Options for line configuration .....	54
Single-phase supply .....	54
Three-phase supply .....	59
System grounding .....	61
<b>VII. Conductor .....</b>	<b>64</b>
Types of conductor .....	64
Overhead vs. Underground .....	69
Conductor sizing .....	70

Rough estimate of voltage drop .....	72
A more accurate estimate .....	72
Spreadsheet estimate .....	73
Effect of conductor size on power loss .....	75
Generalized equations .....	76
Stringing and sagging the conductor .....	77
Sag .....	80
Handling and inspecting the conductor .....	81
Preparation for stringing .....	81
Pulling the conductor .....	81
Sagging the conductor .....	83
<b>VIII. Poles .....</b>	<b>86</b>
Pole options .....	86
Wood .....	87
Concrete .....	94
Steel .....	96
Sizing .....	97
Length .....	97
Girth .....	99
Setting poles .....	103
<b>IX. Poletop hardware and connectors .....</b>	<b>105</b>
Joining conductors: Connectors .....	105
Twisted connections .....	106
Split-bolt connectors .....	107
Parallel-groove connectors .....	107
Compression connectors .....	108
Securing the conductors: Deadend hardware .....	108
Parallel-groove clamps .....	108
Preformed deadends .....	109
Automatic deadends .....	109
U-bolt-type clamps .....	109
Wedge clamps .....	110
Supporting the conductor .....	110
Racks .....	111
Upset bolts .....	111
Support clevises .....	112
Swinging clevises .....	112
Wireholders .....	113
Other approaches .....	113
Lengthening conductor: splices .....	114
Wrapped/twisted splices .....	115
Compression splice .....	115
Preformed splice .....	115
Automatic splice .....	116
Knotting .....	116



<b>X. Guys and anchors .....</b>	<b>117</b>
Strength of cable .....	117
Guy on a deadend pole .....	117
Guy at a deviation .....	118
Securing the guy to a pole .....	118
Types of anchor .....	119
Sizing an anchor .....	120
<b>XI. Safety and protection .....</b>	<b>122</b>
Introduction .....	122
Grounding .....	123
Theory .....	123
Types of grounding .....	124
Ensuring a good ground .....	124
Protection devices .....	126
Fuses .....	126
Miniature circuit breakers (MCBs) .....	127
Residual current devices (RCDs) .....	128
Protecting the system .....	130
Protecting against overload currents .....	130
Protecting against fault currents .....	131
Protecting against corrosion/oxidation .....	132
Protecting people .....	133
Nature of the hazard .....	133
Origin of body currents .....	134
Lightning protection .....	141
Consumer and operator education .....	142
Summary .....	142
<b>XII. Service connection and housewiring .....</b>	<b>145</b>
Service connection .....	145
Service drop .....	146
Service entrance .....	153
Metering .....	154
Conventional metering .....	155
Alternative “metering”: load limiters .....	156
Housewiring .....	163
Standardized housewiring packages .....	166
<b>XIII. Operation, maintenance, and consumer services .....</b>	<b>172</b>
Operator selection and training .....	172
Regular operation and maintenance .....	173
Consumer education .....	174
Financial obligations .....	174
Disconnection policy .....	174
Theft of power .....	174
Awareness of options for electrical end-uses .....	174
Safety .....	175

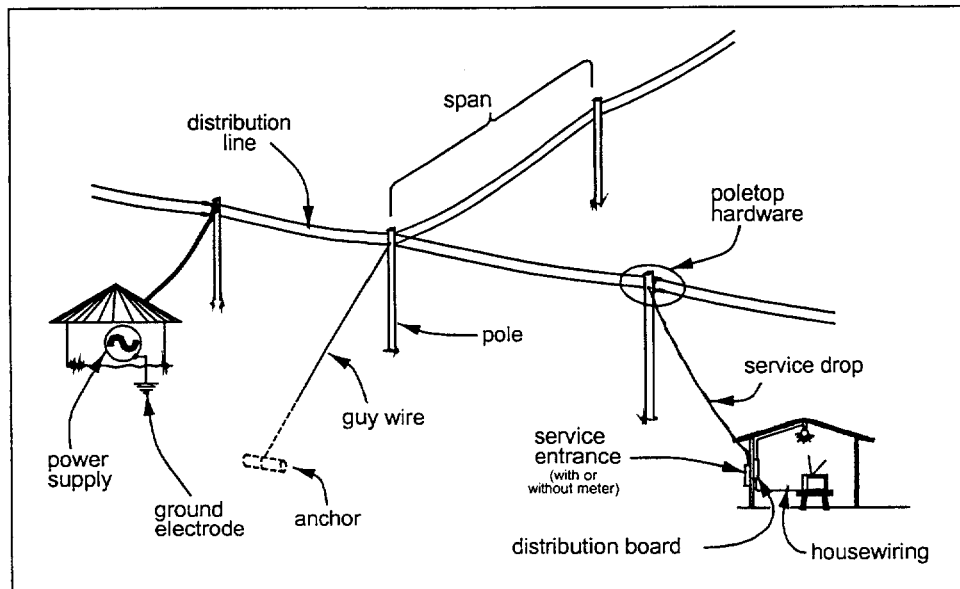
Consumer agreement .....	175
Consumer services .....	177
End-use promotion .....	177
Sales outlet for electrical components .....	178
Battery charging .....	178
<b>XIV. Tariffs .....</b>	<b>179</b>
Introduction .....	179
Project costs to be covered .....	179
Options for covering project costs .....	180
Calculating monthly costs .....	181
Basic tariff types .....	184
Energy-based tariff .....	184
Power-based tariff .....	187
Designing a tariff schedule .....	189
<b>XV. Appendices .....</b>	<b>192</b>
Appendix 1. Case study: Ivory Coast .....	193
Appendix 2. Case study: Ban Nam Thung, Laos .....	199
Appendix 3. Case study: Youngsu, Irian Jaya .....	205
Appendix 4. Case study: El Limón, Dominican Republic .....	212
Appendix 5. Calculating required pole diameter .....	221
Appendix 6. Some basic electrical concepts and equations .....	223
Resistance and reactance .....	223
Power and power factor .....	227
Voltage drop/power loss along a line .....	228
Appendix 7: Computational examples .....	233
(1) Impact of power factor on system cost .....	233
(2) Impact of configuration on distribution system cost .....	235
(3) Sizing a distribution line for motor starting .....	238
(4) Impact of approach to conductor sizing on accuracy .....	239
Appendix 8. Sag tables for multiplex conductor .....	245
Appendix 9. Areas for further inquiry .....	250

## Acronyms, abbreviations, and definitions

A	Ampere, a measure of electrical current
ABC	Aerial bundled cable
ACSR	Aluminum-conductor, steel-reinforced (a conductor made of aluminum, current-carrying strands wrapped around a steel core which provides the mechanical strength)
ac	Alternating current
CCA	Copper chromium arsenate, a popular waterborne preservative that fixes itself to the wood fibers once it has been impregnated into the wood
CFL	Compact fluorescent light
coincident load	The sum of the loads actually on at any instant of time (see p. 44)
conductor	Wire or cable
consumer	A customer (either a household or a commercial establishment) receiving electric power
consumer ground	A grounding electrode located on the consumer's premises, which is bonded (connected) to the frame or chassis of all electrical equipment found there. The consumer ground is <u>not</u> bonded to the system neutral unless explicitly stated. See p. 137.
creep	The elongation of conductor under tension. As tension is applied to the conductor, it stretches and will continue to stretch until a balance between tension and the materials strength is reached, usually after several years. See p. 80.
daN	Deca-newton or 10 newtons, a metric measure of force nearly equal to the weight of 1 kilogram
dc	Direct current
DCS	Development & Consulting Services, a non-profit research and development organization in Nepal that has been involved for several decades in micro-hydropower and rural electrification efforts
deadend	The mechanical termination of a conductor against a support
distribution board	A board or box on or in which are included the necessary items (which might include MCBs, fuses, knife and light switches, and outlets) to control and manage the distribution of electricity within the home. This is located after the consumer's service entrance. Also referred to as a service panel.
dual phase	Three-wire, single-phase configuration obtained by grounding the center tap of the generator or transformer supplying the mini-grid. Also known as split phase.

GECO	<i>Groupe électrogène-économie d'énergie</i> , an approach to electrification focusing on isolated generation, low-demand uses, and broad-based access to electricity, see p. 193.
genset	Generating set, a generator coupled to a prime mover (typically a diesel engine)
guy wire	A wire to restrain unbalanced forces on a pole, also known as a "stay"
HDPE	High-density polyethylene (in this case, used as conductor insulation)
hp	Horsepower, a measure of power, equivalent to about 750 W
kWh	Kilowatt-hour, a measure of electrical energy, obtained by multiplying the power consumed (kilowatts) by the length of time that this power level is consumed (hours)
low voltage	Voltage used to distribute electricity around the village or other load center. It is usually based on a nominal consumer voltage of 120 V or 230 V, depending on the country and is also referred to as a "secondary voltage".
LV	Low voltage
MCB	Miniature circuit breaker, a magnetic or thermal device that opens a switch when current exceeds a preset amount
medium voltage	A more efficient voltage to transmit electricity in bulk from source to load center and usually not found in a mini-grid serving a single village. This voltage is usually in the range of 1 to 35 kV and is also referred to as a "primary voltage".
micro-hydropower	Related to hydropower plants generating up to about 100 kW
mini-grid	A distribution network, usually operating only at a low voltage and providing electricity supply to a community. It is supplied by either its own power generator, such as diesel genset or a micro-hydropower plant, or by a connection to a local distribution transformer connected to an extension of the regional or national grid.
MOV	Metal-oxide varistor, one type of lightning arrester
MV	Medium voltage
N	Newton, a measure of force equivalent to kg·m/s <sup>2</sup> and equal in value to the weight of about 0.1 kg. To convert from a force measured in kg to one measured in newtons, multiply by 9.8.
NESC	National Electrical Safety Code (U.S.A.)
NGO	Non-governmental organization
Ohm's law	$R = E \cdot I$ (see Symbols, p. viii)
Pa	Pascal, a metric unit of pressure, equal to a N/m <sup>2</sup>
peak watts	The output of a solar module under peak outdoor lighting conditions
pico-hydropower	Related to hydropower plants generating no more than a couple of kilowatts
powerpoint	A light fixture or power outlet

PV	Photovoltaic, generating electricity from light, usually sunlight
PVC	Polyvinyl chloride, most popular insulating and sheathing material for low-voltage conductors
RCD	Residual-current device (a device to protect people from potentially dangerous electric shock, also known as a "ground-fault circuit interrupter" or GFCI)
service drop	The conductor bringing power to a home from the nearest power pole
SHS	Solar home system (a solar-PV-based system to provide basic lighting and entertainment needs to an individual home, with a capacity typically in the range of 10 to 100 peak watts)
split phase	Three-wire, single-phase configuration obtained by grounding the center tap of the generator or transformer supplying the mini-grid.
unit	One kilowatt-hour
US\$	U.S. dollars (1999) are used in this manual
UV	Ultraviolet (light which is just outside the visible spectrum but which can be destructive to certain man-made materials such as insulation)
V	Volts



## Symbols

$A$	Conductor area ( $\text{mm}^2$ )
$C$	Capacitance (farad)
$\cos \phi$	Power factor
$d$	Conductor diameter (meters, m)
$E$	Voltage (volts, V)
$f$	Frequency of power supply (hertz, Hz, or, equivalently, cycle per second)
$H$	Horizontal force on pole due to tension in the conductor (newtons, N)
$I$	Current (amperes, A)
$L$	Length (meters, m)
$P$	Power (kilowatts, kW, or kilovolt-amperes, kVA, unless otherwise indicated)
$R$	Resistance (ohms)
$r$	Unit resistance of a conductor (ohms/km)
$s$	Equivalent spacing of conductors of a distribution line (meters, m), see Eqn. (3) and accompanying text on p. 226
$S$	Sag in a conductor (meters, m), see p. 80
$w_c$	Unit weight of a conductor (newtons per meter, N/m)
$x$	Unit reactance of a conductor (ohm/km)
%VD	Voltage drop expressed in percent, e.g., for a voltage drop of 23 V when the supply voltage is 230 V, %VD = 10 (and not 10 %)
$\eta$	Efficiency

## Acknowledgements

The author wishes to extend his appreciation to a number of individuals who have directly contributed to this manual. These efforts have been especially valued because, while these individuals have often been preoccupied with other demanding matters, they have taken the time to share some of their experiences gained over the years.

With over 25 years of experience with the National Rural Electric Cooperative Association (NRECA) supervising and managing rural electrification assignments in Latin America and in Asia, *Myk Manon* has brought a dose of practical experience and a useful perspective. Recognizing the obstacles to cost-effective electrification in the more remote rural areas and the need to be flexible in designs, he has contributed of his experience in several sections of this manual. He was a useful and responsive source of information on a variety of issues that arose during the preparation of this document.

*Dr. Adam Harvey* has been involved for a number of years in designing and implementing rural energy systems, focusing on micro-hydropower technology, as well as being involved in a range of overseas development efforts. He made initial contributions to several chapters of this manual before recognizing the time and efforts which would be necessary in Laos where he is presently facing the challenge of implementing an off-grid electrification project under the auspices of the local utility, Electricité du Laos.

*Dr. Nigel Smith*, presently Managing Director of Sustainable Control Systems and Principal Research Fellow at Nottingham Trent University, has 14 years of experience in R&D, technology transfer and consultancy for small hydro systems and low-cost electrification around the world. He contributed to the chapter on service connection and housewiring, which also includes a description of a load limiting device he recently developed to make access to electricity less costly for low-income households.

As a Research Associate for the Micro Hydro Group at Nottingham Trent University, *Phil Maher* is responsible for a technology transfer project involving village electrification in Sub-Saharan Africa. He is also working towards a PhD focusing on the optimization of stand-alone electrification systems using pico-hydropower. He has experience in the design of mini-grids from Nepal and Ethiopia. In between his activities, he has found the time to contribute text for several chapters in this manual and has continued to contribute by promptly responding to miscellaneous inquiries as they arose.

While numerous individuals and organizations throughout the world have constructed mini-grids to bring the benefits of electrification to rural consumers, few of these experiences have been documented. Interested individuals have therefore not been able to build on these lessons learned. In light of this dearth of documentation, the author is appreciative of the efforts of several individuals to take time to share some of their experiences.

*Jon Katz*, working with Ecopartners, a program of the Center for Religion, Ethics, and Social Policy affiliated with Cornell University, has been involved in an innovative pico-hydropower grid project as one component of a multi-faceted development effort in El Limón in the western mountains of the Dominican Republic over the past several years. Jon contributed a case study of this effort for this manual and continued to provide details and photographs of that effort as his work proceeded.

*Mike Johnson* founded Hydro-Technology Systems, and his work with the manufacture of micro-hydropower equipment in the U.S. eventually led to his involvement in the construction of a 170 kW mini-hydropower mini-grid on the island of Kalimantan. He continued work in that part of the world by initiating a technology transfer program in Irian Jaya, Indonesia, where he spent the subsequent 10 years

training local staff and implementing over two dozen hydropower-supplied mini-grids in the course of those activities. The project at Youngsu documented in this manual is his contribution.

For the preparation of the case study from Laos, the village headman, *Mai Kaen Sengmala*, and villagers from Ban Nam Thung, welcomed and hosted the author on several separate occasions and shared details on the origin, construction, and operation of a self-help village electrification project they had themselves initiated from a shared desire to bring a valued urban amenity to their community.

Safety is an important issue in the design of mini-grids servicing rural communities still unfamiliar with electricity. Frequently, this subject is either given low-priority in an effort to reduce the cost of electrification or used as justification for blindly adhering to standards prepared for much larger systems, leading to greater costs than necessary. To ensure a safe system at minimum cost, it is necessary to return to basics to question what is actually necessary, when it is, and why. With a firm knowledge of conventional electrification system design, NRECA's *Jim VanCoevering* was able to clearly address my inquiries and concerns on the type and extent of grounding required for low-power mini-grids as well as on a number of other topics as they arose. The thoroughness and the clarity of his responses were of considerable assistance in working through these issues.

The author also appreciates the efforts of *Jim Carter*, wood preservation specialist with NRECA's Wood Quality Control program, and a number of other individuals who have promptly volunteered information to fill in gaps encountered in the preparation of this document. The author's appreciation and respect also goes to all those individuals around the world who have set examples through their own small efforts at electrification and who have illustrated that such efforts can begin satisfying the demand for basic electrification among those deprived of this amenity simply by virtue of where they were born.

This manual is an expanded update of an earlier document prepared under contract with Electricité du Laos, with the financial support of the Japanese Policy and Human Resources Development (PHDR) Fund. The project idea and TOR were developed by ESMAP as part of its design of the GEF-financed decentralized rural electrification component of the IDA-financed Southern Provinces Grid Integration Project.

Allen R. Inversin  
International Programs  
National Rural Electric Cooperative Association  
Email: [allen.inversin@nreca.org](mailto:allen.inversin@nreca.org)



# I. Introduction

---

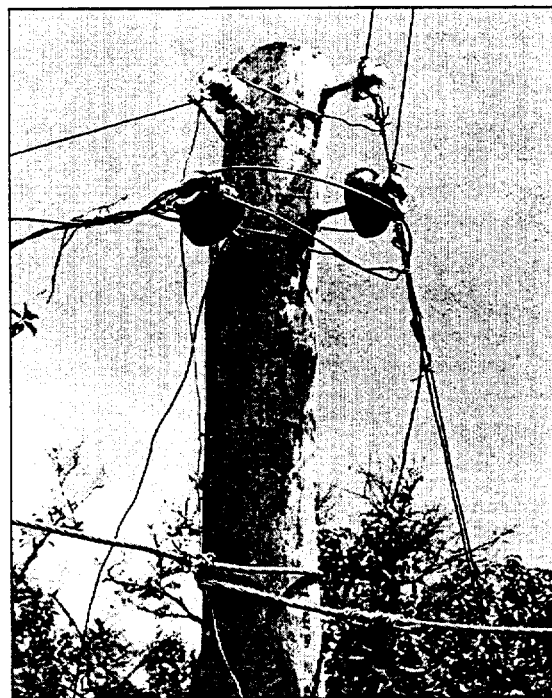
The benefits of electrification are well known and demand for electricity service is widespread. But, because established utilities have often been preoccupied with meeting the needs of the vocal and economically attractive urban areas and with maintaining existing systems, many have been unable to address needs of rural villages. Consequently, around the world, in rural areas beyond reach of the national grid, numerous individuals and communities have taken it upon themselves to construct their own rudimentary electricity distribution systems supplied by isolated power sources, such as hydropower plants or diesel gensets. These mini-grids hold out the promise of being the lowest-cost means of providing electricity to neighbors or entire communities. However, they are often improvised, inefficient, unsafe, and short-lived (Fig. 1). Both national electric utilities and development organizations are therefore reluctant to encourage and support such indigenous efforts in spite of their potential benefits. Furthermore, no guidelines exist for those interested in constructing mini-grids to a higher standard of service and safety.

This manual has been prepared to encourage and support the design of improved village electrification schemes. It presents the theory as well as actual field experiences. It is anticipated that it will be useful to rural development agencies and to national and provincial energy companies and authorities. It is also hoped that, perhaps through intermediaries who have some command of basic technical skills, it will be useful to village entrepreneurs and village development committees.

In this publication, a mini-grid refers to a low-voltage (LV) network within a village or neighborhood supplied at a single point by, for example, a diesel genset or micro-hydropower plant (Fig. 2). It includes the service connections and housewiring. It does not refer to the interconnection of two or more separate village grids into a more extensive area-wide network. The designs covered in this manual range from low-cost designs to serve basic lighting needs to more conventional designs that may become interconnected to the grid within the near future.

This manual assumes the existence of a power supply and does not deal with details of this supply. It rather focuses on the design of the system to distribute the power generated to the consumers.

Mini-grids as discussed in this manual do not involve the use of any medium voltage (MV). However, it should be recognized that it may occasionally be necessary to use MV to reduce overall cost. This



**Fig. 1. The two thin vertical conductors just to the left of the pole bring power up from a 350 W hydropower plant at its base in a village in Colombia. From this pole, it is distributed using bare conductors to several homes in three directions. Twisted conductors are used for all connections. Two guy cables at the bottom encircle the pole. (Photo credit: Phillip Maher)**

may occur when serving two or more discrete load centers separated by some distance or when transmitting power from a generation source plant located at some distance from the load center. In this case, transformers would be required. Medium-voltage lines are outside the scope of this manual.

This manual includes the following:

- A summary of several examples of mini-grids from around the world to illustrate the context in which such projects have been implemented. More detailed case studies are found in the appendices.
- Qualitative descriptions of the issues to be addressed in planning for a mini-grid.
- A range of design options for the various components of a mini-grid and how these are sized and incorporated into a mini-grid.



**Fig. 2. A micro-hydropower plant serving remote households scattered on the hillsides near Gotikhel, Nepal.**

The guiding principles for the design of mini-grid systems should be that they be safe, adequate, expandable, and efficient. Systems are **safe** if they present no greater hazard to the public than standard urban grid-based systems. This can be achieved by ensuring that they are designed in compliance with the spirit of any electrical codes or standards in use in the country. The word "spirit" is critical here because accepted standards are sometimes designed for conditions not found in rural areas where mini-grids might be found. For example, to reduce cost and thereby increase accessibility to electricity in rural areas, small conductors may be recommended as appropriate where loads will not, in the foreseeable future, even approach those found in urban areas. But the same conductor might be deemed unsafe according to the codes adhered to in an urban environment because increased current demand there could lead to a fire hazard. In such cases, blindly abiding by these standards makes electrification unnecessarily more expensive and less accessible to rural populations.

Systems are **adequate** when they deliver sufficient power when and where needed, with the required degree of efficiency and service quality.

System **expandability** implies the use of designs that minimize life-cycle cost by making provision for a certain degree of expansion, obviating the need to replace or rewire portions of the system as the load increases.

An **efficient** system is one that provides acceptable electric service at minimum cost over the expected life of the installation. It may not be efficient, for example, to use materials that are low-cost but whose low quality requires that they be frequently replaced or repaired or which present a safety hazard. Neither may it be efficient to save on cost by restricting the capacity at the service entrance or housewiring level below that which could conceivably be used or to decrease conductor size and cost if that leads to excessive voltage drop and power losses or to unsatisfied consumers.

If village power systems relying on mini-grids are to be sustainable and therefore widely replicable, designs specific to the conditions found in villages must be prepared. There is a need to break out from the standard mold, to review specific needs in a community, to go back to basic principals, and to develop designs that most cost-effectively address those needs. Without this approach, complexity and high costs can quickly place mini-grids beyond the reach of the typical village. The manual therefore not only reviews a range of technical designs but also covers in depth some of the other issues that must be addressed for successful, affordable electrification programs.

From the four case studies presented in the appendices and summarized in the next chapter, the range of options available is clear. These projects, most serving somewhat more than 100 households, were specifically designed for bringing electricity to isolated villages. However, even under these circumstances, one finds a wide range of costs and sophistication, from a village mini-grid system costing about \$3,000 in Laos to a number averaging more than \$90,000 in the Ivory Coast. In addition, a generating plant is required to supply the mini-grid with electricity. This adds from \$1,000 to \$9,000 for diesel gensets in Laos and the Ivory Coast, respectively, to from \$4,000 to \$20,000 for a micro-hydropower plants in the Dominican Republic and Irian Jaya, respectively.

Any one of these designs is not necessarily better or more appropriate than any other. Each was simply designed to meet a particular set of conditions under a specific set of constraints. But they do illustrate that numerous variables must be considered in the design of mini-grid and that it is not simply a case of using the same design in different locations, as is generally done by national electric utilities around the world. In addition to describing technical designs, an important objective of this manual is to increase awareness of the range of issues that must be addressed in bringing the benefits of electricity to rural people around the world.

This publication presents graphs, equations, and other quantitative and qualitative details to provide guidance for the selection and sizing of the various components that could be incorporated in an electrical mini-grid. But for such projects, sizing is relatively straightforward. Of greater importance in implementing affordable and sustainable mini-grids is an awareness and understanding of the numerous other issues that must be addressed and resolved. The basic issues encountered in the design and implementation of "standard" electrification were resolved long ago, and designs adopted by national electric utilities vary slightly from country to country around the world. However, if these same designs were to be adopted for mini-grids, costs would be high, and rural populations would never have a chance to access the benefits of electrification. Alternatively, such projects would require government subsidies, but this is an option to which few countries seem able or willing to commit.

The range of design options is much more varied with mini-grids, driven primarily by the fact that systems must remain affordable, yet adequate, if electrification is to be more widespread. Only designs that achieve this will prove sustainable and replicable. But this requires that numerous issues be resolved. Examples of such issues include the following:

- Most mini-grids are not grounded. What level of grounding is warranted? And how, after going through the expense and effort of grounding, can the effectiveness of grounds in providing a safe environment be ensured in a rural setting?
- To ensure safety yet minimize the cost of electrification, what minimum components must be included in the consumer's residence?
- What approaches are there to reduce the cost of meters, meter reading, billing and collecting, because these can often cost more than the cost of the electricity consumed?

- What types of conductor are most appropriate and available in the small sizes required for mini-grids?
- Should single- or three-phase distribution be used?
- How can adequate service quality be maintained such that user appliances are not damaged?
- While service to urban consumers must make provision for supplying at least 1,000 watts and often considerably more, how can mini-grids be redesigned to cater to a maximum domestic demand of perhaps 20 to 100 watts per household?
- How can conductors be joined when the appropriate connectors are not available for the sizes commonly needed for mini-grids?
- Adopting conventional designs would result in excess system capacity at a cost that the community could never afford. How does one assess the actual needs of a community to ensure that the system is not overbuilt and priced out of range for the community?

These are some of the issues that must be addressed before even embarking on the design and sizing of a mini-grid. Consequently, while equations and graphs have been included, much of the manual focuses on increasing awareness of these and related issues and on providing insights gained to date by those who have already designed and constructed such systems.

Furthermore, while an objective in mini-grid design is to minimize the cost of electrification for rural consumers so that they may access, and benefit from, this resource, several guiding principles must be kept in mind:

- Making electrification more affordable does not simply require minimizing the total cost of components at the time of construction. Rather, the implications of system design on life-cycle cost and system performance must be kept in mind.

For example, while the use of small, locally harvested, untreated wooden poles may appear an effective means of reducing the cost of one of the most expensive components of a mini-grid, the labor and materials cost for their subsequent frequent replacement may not only quickly overwhelm any initial cost savings, but it can put the sustainability of entire system in jeopardy.

As another example, if the potential exists for increased user demand in the future, life-cycle costs may actually be decreased by initially oversizing the distribution line. If costs are minimized by keeping conductor size to the minimum required to meet initial demand, then it will later have to be replaced with larger conductor. The additional labor to replace the conductor as well as the additional materials will unnecessarily increase project cost.

- Minimizing system cost may not necessarily be achieved by simply minimizing the cost of each component making up that system. The system designer must realize that the design of one component can have implications on the design and cost of others. For example, as will be described later, increasing project cost somewhat by incorporating capacitors in the design of fluorescent lighting units to correct their power factor can result in net savings by allowing for the use of smaller and less costly conductor and generator.

## II. Setting the context for low-cost mini-grids

---

Electrification first began in the urban centers in the industrialized nations and evolved in the following context:

- A geographically compact service area, facilitating the supply of electric power.
- A variety of end-uses (from powering lights and radios to heavy industry) leading to a wide range of per-consumer demands.
- A consumer base with ready employment and access to financial resources to cover the costs of installing electrical service (the connection cost), purchasing end-use appliances, and covering the costs for electric energy (the monthly kWh bill).

Over time, standard technical and institutional designs evolved to most efficiently serve these centers.

When electricity was later introduced by these nations into cities in areas they had colonized around the world, the natural approach was to utilize these same standard designs. But in this new context, these designs were still largely appropriate, because comparable conditions were found in urban areas in the developing as well as in the industrialized nations.

But as the demand for electricity spread beyond the urban areas, first into the less wealthy but still densely populated periurban areas and later into the rural areas with poorer, more dispersed populations with more basic needs, electric utilities simply expanded the systems using designs with which they were most familiar. But gradually, as the electrical network expanded, utilities found this work to be detrimental to their economic well-being: costs of supplying electricity increased and per-consumer consumption, and associated revenues returning to the utilities, decreased. The utility response was either to avoid serving these areas or, if the central governmental directive to serve the rural populations was strong, to request the necessary financial resources to subsidize these efforts in areas beyond the towns and cities.

But the demand for electricity continued unabated and the more enterprising, unserved areas undertook their own electrification, relying on locally generated power. They also recognized that standard designs which had been used could not always affordably meet their needs. As a consequence, a range of new, less costly designs evolved. These new designs recognized the new context in which electrification was to evolve:

- Isolated service areas, often requiring local generation to avoid the high costs of bringing power to these areas.
- A range of more rudimentary needs, often focusing on meeting small energy needs—such as for lighting, entertainment, and, to a limited extent, the operation of simple handtools and appliances—but at the same time, occasionally considering the limited use of some more electricity-intensive uses such as agro-processing or cooking.
- A broad range of affordability on the part of individual consumers, but with most consumers having more limited access to financial resources.
- Because of their eagerness to get access to electricity, the increased willingness of potential consumers to be actively involved in the supply of their own electricity rather than being merely the recipients of services from an outside company.

- The possibility that mini-grids would be interim measures and would not have to be designed to last the 30 or more years that is (or at least should be) the case with conventional systems.

In conventional electrification around the world, designs that are fairly standard from country to country have been developed. But even in these cases, costs can vary broadly. In striving to develop new, less costly designs to serve individual communities, it is clear that, because of the broad nature of the context in which electrification is to be undertaken, no single standard design could be developed as was the case with urban electrification.

Designs developed or adopted for mini-grids depend heavily on such factors as the size and nature of load that is to be imposed; on the design life that is expected of the system; on the availability and cost of materials, most notably poles; on the metering system which is to be incorporated; and on the level of safety felt necessary.

To provide the reader with an idea of how designs evolved in different contexts to bring electricity to isolated communities, four case studies from around the world have been summarized below and included in more detail in the appendices in this manual. These projects have common characteristics:

- Reliance on an autonomous electricity supply, which is either a diesel or gasoline genset or, where hydropower resources exist, a micro-hydropower plant.
- Meeting basic, low-power needs which are most efficiently provided by electricity, primarily high-efficiency fluorescent lighting and entertainment (radio and TV).
- In cases where fossil fuel is used, restricting the hours of generation to early evening hours to ensure an efficient loading of the powerplant.
- Dependence on the local community to provide sweat equity and local materials and to manage and operate the schemes.
- Reliance on fixed tariffs based on connected load (watts) and not on actual consumption (watt-hours), obviating the need for energy meters and associated administrative costs.

But in spite of this commonality, these case studies illustrate the broad range of designs that have evolved and the wide range of costs that are possible—from about \$3,000 to \$90,000 for the mini-grid and housewiring alone, to serve roughly the same number of consumers.

And while one objective is to adopt designs that can reduce the cost of electrification, another should be to maximize the benefits which can be derived from electrification. If the cost of fuel is relatively high, such as with diesel generation, an effort must be made to use available energy efficiently, by reducing losses to the extent possible and to displace even costlier sources of energy, such as dry cells. If the cost of fuel is low, such as with hydropower generation where the “fuel” is free, then as many productive uses as possible should be considered (Fig. 3).

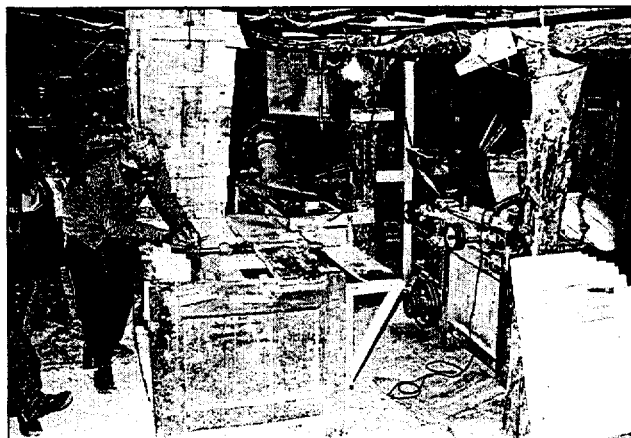
## **Ivory Coast**

A design developed by a French organization for several western African nations, including the Ivory Coast, is one that might be expected from individuals who have been schooled in conventional designs but who, at the same time, recognize the new context in which off-grid rural electrification is to be implemented.

As might be assumed from the relative high project cost, which approaches \$650/consumer, each system incorporates conventional designs and components, although these have been down-sized to cater to the

new, reduced demand levels. But with the still high costs of this project come additional benefits which are not generally associated with the other case studies presented:

- To ensure consumer safety, residual current devices (RCDs, see p. 127) and more expensive underground distribution in the vicinity of the consumers have been used.
- While the designs adopted are considerably costlier than those of the other projects described in the appendices, they should also have a considerably longer life and require less ongoing maintenance and replacement.
- By using conventional designs and components, the objective is to have a system that, at minimum cost, can be connected directly to the national grid, when it arrives in the village at some time in the future, and be in accordance with established national standards. At the time of grid-interconnection, a distribution transformer would simply replace the powerplant.
- Fluorescent lighting is power-factor corrected. This reduces line losses that are encountered in the other cases presented, losses that detract somewhat from the efficiency normally associated with fluorescent lighting.



**Fig. 3. This micro-hydropower plant owner in Nepal is sharpening scissors using an electric-motor-driven planer, jointer, grindstone, and circular saw combination. In addition to generating electricity for lighting and to power handtools, he uses mechanical power directly for oil expelling, flour grindings, and rice hulling. The penstock pipe to the turbine is located in the center background.**

What is not clear from the information available on this project is whether, in an attempt to reduce cost, the conductor has been sized to meet only the average load the project designers expect (30 to 60 W per consumer). If this is the case, then reconductoring of the distribution system would be required if, when the grid arrives, consumers are ready to increase their consumption. This would increase the life-cycle cost of the system.

While numerous advantages enumerated above are associated with this project design, the question that remains is whether such a design makes the system too expensive and therefore too heavily reliant on external funding to be replicable in an environment with increasing competition for limited public funds. On the other hand, the observation was also made that consumers presently spend more for electricity than they previously spent on alternative fuels displaced by electricity. Their motivation for doing so should be probed to determine consumer willingness to pay and to assess under what circumstances, if any, they can cover actual system cost.

Further details about this project are found in Appendix 1.

## Laos

Unlike the design prepared for the Ivory Coast, the design used in the village of Ban Nam Thung in northwestern Laos was prepared by a young man who had recently completed agricultural training but who had no formal electrical training. It probably represents the most basic, minimum-cost, mini-grid design, requiring only several sizes of conductors and a few components in each housewiring circuit. Poles are usually one of the more costly components of conventional electrification projects. For this project, live trees were used if they were in a suitable location; at other times, villagers contributed hardwood and bamboo posts, but these were untreated and had to be periodically replaced.

For the type of mini-grid and housewiring design used, capital costs average about \$20 per consumer. A low-cost Chinese 230-V genset was also used. Project cost was low, and the factor most affecting the viability of this project at present is the cost of diesel fuel which has been rapidly increasing as the Lao currency devalues.

A visit to the project site revealed several problems, which arose from a lack of knowledge of proper system design rather than due to an attempt to cut costs. Incorporating design changes to resolve these problems may double the capital cost for the system, but this would still have been a very low-cost system. Problem areas include the following:

- Lack of control over consumption. The tariffs were based on total connected load, generally one 20-W fluorescent lamp per consumer. However, there was no enforcement, and including one to three power receptacles in each home invited the use of appliances. Over-consumption by one or more consumers may have been one reason for the 10-kW generator running hot and eventually burning out.

Each home has fuses, but at a rating of about 10 amps (the smallest size fuse wire available on the local market), these are more to protect conventional housewiring than to limit consumption. If outlets are to be included in each home, provision should also have been made to include a properly sized fuse, circuit breaker, or other form of load limiter (see p. 155).

- Inappropriately sized conductor. A 7-mm<sup>2</sup> aluminum conductor was used for a circuit length in excess of 1 km. To ensure a suitable voltage at the end of the main line, the generator was run at over 250 V. This not only resulted in reducing the life of lamps near the generator but also placed an additional load on the generator, probably contributing to its eventual failure. The area of this conductor should have been somewhat more than doubled to keep voltage drop within the main village (about 350 m long) to within an acceptable voltage. But even then, the second village of about 20 households centered at about 700 m from the generator would still have been too far to also be served with the same conductor (Fig. 4).



**Fig. 4. The conductor used along this stretch of line between two villages is too small for the loads and distances involved.**



- Lack of power-factor correction for the 20-W fluorescent lamps which were the principal load on the system. The generator was rated at 3.3 kW per phase at a power factor of 0.8. This means that while the generator could have produced 4.0 kW per phase if the ballasts had been corrected to a power factor of 1.0, it only had the capacity to produce 2.0 kW with the uncorrected fluorescent lamps in place (with power factor of 0.5). It is conceivable that the lack of capacity-correction contributed to overloading the generator.
- Poor phase balance. Only two of the three phases at the generator output were used, permitting full use of only two-thirds of the generator's 10 kW. Furthermore, a considerably greater number of consumers were served by one phase than by the other. Consequently, unbalancing of the generator output as well as excessive loading of one of the phases may also have contributed to eventual generator failure.

While numerous design problems were encountered at this site, this project illustrated a basic design that showed the promise of being very low-cost. Even if the conductor size had been increased to reduce voltage drop within the main village and breakers had been used in the home to avoid the problem with the use of incorrectly sized fuse wire, project costs would probably have been roughly \$30 to \$40 per household.

Further details about this project are found in Appendix 2.

## **Irian Jaya**

Irian Jaya, which forms part of the nation of Indonesia, is a rugged island with isolated population centers. This, coupled with high precipitation, makes it an area with significant micro-hydropower potential. In this case, the hydropower plant provides 24-hour power to the community.

As with the project in Laos, this is also a fairly rudimentary system. The major difference in cost is attributable to the significantly increased conductor size used for the main line. It is instructive to note that this project had a very similar configuration to the Lao project. They both had a generator of about the same capacity, generating at the same voltage, and serving roughly the same number of consumers over about the same geographical area. However, rather than using the equivalent of about 2.0 km of 7 mm<sup>2</sup> aluminum conductor, the project in Irian Jaya used more than 3.5 km of at least 35 mm<sup>2</sup> aluminum conductor.

Even with its more than adequately sized conductor, per consumer cost for the mini-grid and housewiring averaged \$60 per household. The powerplant averaged another \$130 per consumer. However, because the provincial government covered the capital cost of the mini-grid, villagers were only responsible for the housewiring at about \$22, plus somewhat more than \$2 monthly to cover operating costs.

Further details about this project are found in Appendix 3.

## **Dominican Republic**

The Dominican Republic is a country having one of the broadest experiences worldwide with harnessing solar photovoltaic (PV) power and making efficient use of the small amount of low-voltage (12 V) direct current (dc) energy generated by such systems. It also makes wide use of the small streamflows found in its numerous streams, by transporting water long distances in polyvinyl chloride (PVC) pipe for pressure (gravity) irrigation.

While solar home systems were available, their capital cost and recurring cost (largely for the batteries which needed periodic replacement) would have placed an unacceptable burden on the villagers. When the idea of using a turbine to convert the energy of the water in the irrigation pipe into electricity was proposed, this seemed an attractive option. It was clear that only small amounts of power could be generated per family (roughly 30 to 40 W) because of the size of the available pipe flows. However, because of cost, the villagers were eager to devote their efforts to building a pico-hydropower plant and mini-grid and using the PVC pressure pipe for two purposes simultaneously: irrigation and power generation.

In the Dominican Republic, several advantages were associated with the use of low-voltage direct current (dc). Fluorescent lamps run off dc were readily available, and use of dc reduced potential safety and fire hazards in village households with little prior experience with electricity. The brightness of the dc lamps appeared very insensitive to voltage. The availability of dc in the home held out the promise of battery-charging, permitting significantly more power demand per household. And finally, use of dc power discourages the purchase and use of high-power appliances and devices, uses which put small systems at risk. The reduced availability of dc appliances and devices on the local market also reduced this risk.

It was decided that each household would have access to dc power in the home but that the mini-grid would transmit at 240 V alternating current (ac) to reduce the size and cost of conductor used in the mini-grid for transmitting power from the powerhouse to the village. At the top of the pole nearest each home, at the beginning of each service drop, a transformer/rectifier unit with circuit breakers was installed to provide dc power to each home.

In reality, the transformer/rectifier unit had two disadvantages: it increased the cost and complexity of the connection and it resulted in the loss of power. While this loss was estimated at 10 W per household, this is a fairly significant portion of the overall power available. There was the advantage that this unit limited the power that could be used and ensured equitable distribution of power to all villagers but, in theory at least, a current limiter could also have been used with an ac system. Time will tell whether conversion to dc was an effective approach to take.

The mini-grid system, with dc conversion and housewiring, cost on the order of \$500 per consumer, with villager-produced concrete poles and international transportation of materials accounting for about 40 % of this cost. The powerplant added the equivalent of another \$70 per household and a further \$200 per consumer would have been added if the cost of the pressure pipe had not been assumed by the irrigation project.

Further details about this project are found in Appendix 4.

## **Conclusion**

The project summaries highlight the wide range of capital costs per consumer possible for mini-grid-supplied electricity. If one were to restrict project designs to those described for the Ivory Coast and the Dominican Republic, their high cost would probably preclude the electrification of most villages around the world. Significant grants and subsidies would be required and the question is whether these could be justified to the donor's satisfaction in light of the benefits derived.

The other two projects presented—those in Laos and Irian Jaya—seem more attractive because they promise considerably reduced capital costs. On the other hand, higher recurring costs would be expected for maintaining and repairing these lower-cost and consequently less robust systems. One question that

remains is how much the cost incurred in these ongoing repairs and replacements adds to project cost? Would projects with lower capital cost also have lower life-cycle cost?

Another question to ask is whether it is more effective to design and implement a high-cost, well-designed system at the outset, when all the expertise is on-site, than to build a lower-cost system by using less durable materials and designs and hoping that proper repairs will be made in subsequent years as they are required. An engineer implementing projects in Indonesia writes:

I've come to the conclusion that "distribution" must be planned with a long term perspective—it's a nice idea to say we build and use bamboo posts temporarily and will gradually replace them with steel or concrete as they rot but how many people ever get around to doing it?<sup>1</sup>

The challenge facing those charged with implementing sustainable and affordable mini-grids is to synthesize safe designs that meet villager needs while having the lowest life-cycle costs. In the process, they must keep in mind that, without properly trained local staff and possibly a mechanism for providing technical backstopping, most repairs may not be properly made. Temporary fixes will probably be undertaken—poles will be temporarily braced if not left to dangle, fuses will be bypassed and no longer serve their intended purpose, and hooked wire ends will replace broken switches. This will further increase life-cycle costs or decrease system life over what was planned. Consumers are put at risk and the initial investment may not yield the expected benefits.

Once the most appropriate, lowest life-cycle-cost design has been achieved, the questions that still remain are whether final project costs will be affordable to the community and whether the design is sustainable. And if the project is a pilot project to be adopted elsewhere, another question is whether the final design is replicable. If not, the potential impact from the effort expended on this pilot project will have been considerably reduced.



### III. Preconditions and action plan

---

In the enthusiasm to get access to electricity in areas far from the grid, there is often an eagerness to immediately get down to the job—gathering and setting poles; stringing conductor; buying fuses, housewiring, and lighting fixtures; etc. However, before purchasing the necessary materials and setting up a system, the proper design must be established. But even before this, it is critical that the necessary elements for a successful project are in place. While ensuring this may not guarantee success, omitting to consider them is a sure recipe for failure. These elements include the following:

- Widespread interest in accessing electricity and the ability of a sufficiently large portion of the population to cover, at the very least, the recurring cost of the project, if not a significant portion of its capital cost.
- Identification of a well-established, suitably qualified local entrepreneur, organization, etc., that is initiating the request for electrification and that will have prime responsibility for managing and operating the project on an ongoing basis.
- A potential source of electricity in the vicinity of the community in the quantities and at the times needed.

Because each of these three elements is critical to project success, a careful assessment of each in a specific situation must be made before undertaking any work on the installation of a mini-grid. Failure to address them would put the entire project at risk.

It should be noted that a precondition that is assumed to be met before initiating a project is that national laws permit the generation and sale of electricity by private individuals or by organizations other than the national utilities. If this is not the case, exceptions to the law must be sought; otherwise those implementing such projects could be placing themselves, their investment, and their consumers at financial risk.

#### Willingness and ability to pay

People in all walks of life are eager to get access to electricity; however, this is clearly not a sufficient condition for embarking on the implementation of a mini-grid project. Coupled with this must be both the willingness and ability to pay for this service.

The cost of service includes the following components:

- Capital cost incurred in the implementation of the mini-grid project, with powerplant
- Recurring fuel cost (unless solar, micro-hydropower, or windpower is harnessed)
- Recurring operations, maintenance, and overhauling costs, both labor and materials
- Equipment replacement costs

These costs can be covered by several means:

- Grants and subsidies from the government, bilateral aid organizations, or non-governmental organizations
- Villager up-front contribution (such as through a connection fee)

- Loans

A portion of the capital costs may be covered by grants and subsidies. Villagers themselves may also cover part of these costs up front. But while aid donors or governments might cover at least a portion of the capital costs, they are rarely, if ever, willing to take on the responsibility of assuming the ongoing costs incurred in the operation and maintenance of such projects. These ongoing costs, as well as the balance of the capital cost, must be covered by the consumers themselves through their electricity bill. Any tariff schedule used to set consumer bills should therefore be properly designed to generate the necessary revenues to cover these costs. If the villagers are not willing or able to cover these costs, the advisability of proceeding further with the project should be reconsidered.

Precisely establishing the cost of electrification is difficult before a project has been designed and costed. However, the case studies presented in the appendices and summarized in Chapter II provide an idea of the broad limits within which the costs will likely be found, depending on the sophistication of the actual design adopted.

The most basic mini-grid/housewiring system is one requiring a conductor down the main streets, service drops on either side of the conductor, housewiring, and a basic distribution board and fluorescent light in each home. The cost may average \$30 to \$60 per household. It would rely on locally available poles donated to the project by the community. (See the case studies for Laos and Irian Jaya as two examples of such projects.)

On the other hand, by using more permanent concrete or treated wood poles or some underground construction, greater consumer and system protection, and higher-quality distribution boards and components, distribution system cost may average closer to \$500 per consumer, approaching the cost of a more conventional distribution system. (See the case studies for the Ivory Coast and the Dominican Republic for two examples of such projects.)

Note that along with the above, the capital cost of the power supply itself must be added. This cost is highly variable, especially for small powerplants, and depends on factors such as size, the type of power being harnessed (e.g., hydropower or thermal power through a diesel plant), site conditions, the manufacturer and quality of the equipment, and powerhouse design. In addition, while the initial cost of a gasoline or diesel genset may be low, the cost of repair, overhaul, or replacement could add considerably to the life-cycle cost of the plant. This cost, in turn, would have to be recouped by the project owner through the tariff imposed on the consumers. In addition, the recurring cost of the fuel must be considered. The initial cost of a small hydropower plant may be high but recurring costs for repair, maintenance, and "fuel" should be considerably lower. This cost would generally have to be borne by the consumers through their electricity bill.

Therefore, while electrification is not inexpensive, costs incurred in the construction of mini-grids can vary widely. The same is true of the monthly payments expected of the consumers. To assist in assessing whether a community can afford to cover these costs, it is useful to obtain a rough estimate of how a given project cost is reflected in these consumer payments. This will give those proposing a mini-grid project an indication of whether, or under what circumstances, such a project could reasonably be expected to succeed financially.

As a frame of reference, assume that a proposed, very low-cost, low-power village mini-grid, including of a small diesel genset, costs \$10,000 and is to serve 100 consumers. Assume further that all costs are to be covered by the community and that loans are available on reasonable terms (here assumed to be 10 % annually over 5 years). Using Table 19 (see p. 182) and interpolating, monthly payments to repay a loan

for the full amount can be calculated as  $(\$10,000)(0.023) = \$230$  per month or an average of \$2.30 per consumer. This payment is proportional to project cost and inversely proportional to the consumer base. For example, if the project were to cost \$50,000, the average cost per consumer would be  $5 \times \$2.30$  or \$11.50/month. Or if the consumer base for the original \$10,000 project were only 50 or half the consumer base originally assumed, then the cost per consumer would be  $2 \times \$2.30$  or \$4.60/month. If the project costs \$50,000 and serves only 50 consumers, then the average monthly bill would reach \$23.00/consumer.

Since the mini-grid is supplied by a diesel engine, the price of fuel would have to be added to the figures above. To serve small fluorescent lighting and entertainment loads during the evening, this might cost an additional \$1 to \$5 per consumer each month, depending on the cost of diesel fuel and actual consumption. In addition, the cost of operation, maintenance, and repair for the plant and mini-grid each contribute to the total cost that must be covered, whatever the source of electricity.

A more detailed derivation of an average tariff can be found in Box 16 near the end of this manual (p. 191). By assuming a certain project "sophistication" and its associated cost as noted above, assessing what portion of these costs are to be borne by the consumers themselves as opposed to being covered by grants, and then establishing the terms under which the consumers are to cover these costs, it is possible to estimate the amount each consumer will be required to pay monthly to cover project costs. The next task is to assess whether the rough cost of electricity supplied by a mini-grid project of the scale and type assumed, derived through this process, is affordable to the local community.

One approach to assessing the villagers' ability to pay is to assess how much they currently spend on energy that would be offset by electricity, such as kerosene and candles for lighting and dry cells and automotive batteries for use with radios and TVs. The term "offset" is important because, even if electricity is introduced, most villagers will still have to continue to purchase kerosene for times when the electricity is not being generated or to purchase batteries for flashlights which will continue to be needed outside the home.

Another approach would be to assess what level of electric service those in other comparable villages—but with some access to electricity—currently receive and how much they pay for it. In areas where most households do not have access to a steady income, understanding how this affects their ability to afford mini-grid connection and to regularly pay their bills would also be instructive. This would help in not only establishing the level of the tariff but also its structure (i.e., possibility of prepayment, periodicity of payments, bulk payments, etc.).

Note that in the discussions above, it has been assumed that the loads are primarily residential. In reality, this is typically the situation. In this case, reducing the cost of electrification to residential consumers requires adopting lower-cost designs. However, another complementary approach that should also be considered where possible is to actively incorporate income-generating end-uses among the residential loads. These can include the use of refrigeration or the manufacture of ice to increase the life of fish, fruit, or other foodstuffs; wood- or metal-working equipment; battery-charging; agro-processing such as milling grain or hulling rice; irrigation; etc. These not only generate revenues—which can contribute to covering an important portion of the cost of the energy generated—but they also create or broaden employment and income-earning opportunities both for consumers gathering raw materials to be processed or stored as well as for those directly employed in operating the equipment.

It should also be noted that, with certain end-uses, it may be possible for villagers to more efficiently process crops than with existing traditional methods. In such cases, they may actually be generating more

income than they would otherwise be receiving. For example, in Nepal, oil is expelled manually with what appears like a large mortar and pestle device driven by several women and children, a laborious process. By having access to a newly introduced micro-hydropower plant and an oil press manufactured in the region, considerably more oil can be extracted from the same quantity of seed, leaving the villager with increased income, even after paying the fee for expelling the oil, income they would not normally receive. In such a case, a portion of this additional revenue could be diverted to pay for electricity. The net effect would be that, in constructing a mini-grid that is financially sustainable, villagers would, in effect, be receiving free electricity. They would also be relieved of a strenuous, time-consuming task. Other uses with a similar result might be pursued, such a cold storage to permit additional revenues to villagers by storing fish or fruit for times when they are in increased demand and would command a higher sales price.

### **Identification of a responsible individual/organization**

Typically, each family in a village is itself responsible for purchasing kerosene or batteries to meet its own needs. Its access to energy is not dependent on the actions or commitments of other families within the community. With the introduction of a mini-grid, two other energy supply scenarios are possible, each of which requires a different involvement on the part of potential consumers.

The first scenario is for a private entrepreneur to install a mini-grid, either as another use for his existing diesel plant, which he may be using to mill grain or to hull rice, or as an independent business venture. In any case, he assumes all responsibilities and risks—financial, operational, and managerial. This scenario is the least onerous and presents the least risk both to the potential consumers of electricity as well as to any institution providing grant or loan funding for the project. For its part, each household would see no major difference in its responsibilities. It would still be responsible for paying for its consumption, paying the electricity supplier rather than the kerosene or battery merchant at the local marketplace. Depending on arrangements with the entrepreneur, each family might also be responsible for covering the cost of housewiring as well as an up-front "connection fee" which could cover the cost of connecting up the house to the grid. Beyond this, it could purchase whatever amount of power the entrepreneur permits and could reduce or terminate its consumption at any time at no further cost to itself.

The second scenario is for some form of village ownership. This might be a cooperative or a user group. But in this case, the decision to involve itself in a village electricity project must originate with the community members themselves. It should not be driven by someone from outside who may have been attracted to the village by the presence of an attractive micro-hydropower site or by some local cottage industry that could make productive use of electricity. And whatever the precise form of the organization, this second scenario involves a different level of commitment and risk on the part of the villagers as well as on the part of any lending agency and the external enabling organization, if there is one. The success of this approach requires a unified community, with clear leadership and, preferably, a history of successfully working together on communal projects.

It is also essential that individuals with the necessary skills and long-term commitment be available to operate the system. It may not be uncommon to find an individual in a village who appears eager and motivated to fulfill this role. Suitable candidates might seem to be the young unmarried villager who recently graduated from the local school or a well-respected schoolteacher from outside the community. And if outside enablers excited about finding a project site are involved, they may well have a tendency to latch on to such an enthusiastic individual in their own eagerness to implement a project. This tendency must be guarded against. The question that must be kept in mind, and the one that may be difficult to



answer definitively, is whether such an arrangement is likely to endure. A young person might easily be lured away by the amenities and opportunities in the city and the place of assignment of a teacher may easily change from one school year to the next. On the other hand, using a villager who is tied to the village through family bonds, who has a secure means of making a steady, adequate income within the village, who may already play an important pivotal role in village activities, and who has some initiative and motivation would probably more likely remain in the village and be committed to the long-term success of a mini-grid project.

The second scenario is the more difficult of the two because it requires the active involvement and commitment of most of the individuals within a community rather than of a single individual. It must be clear that some mechanism for organizational continuity exists and that the elements are there for a long-term commitment to the project. In the absence of a reliable and capable individual and community organization, it may be best to forego a project; otherwise, this effort will likely be costly, time-consuming, and frustrating and in the end stagnate and collapse after the outside promoter has departed the scene.

Any mini-grid project should be expected to last for a number of years and will likely require a long-term financial commitment. Therefore, whatever mechanism is to be used for the implementation of a mini-grid project, it is essential that a committed organization be in place to ensure its continued operation.

## **Adequacy of electricity supply**

The electricity for supplying a mini-grid can come from a number of sources, ranging from the conventional (diesel and gasoline engine or a distribution transformer supplied by the national or regional grid) to the non-conventional (wind, solar, or micro-hydropower). Before constructing a mini-grid, it is essential that whatever supply of electricity is proposed be available in the quantities and at the times it is needed. If not, this will not only reduce the end-uses to which electricity can be put but it may also complicate the generation of adequate revenues to cover the costs incurred in electrification. And the power supply should be located sufficiently near the load center to minimize costs in transmitting power to the village loads.

Several electricity supply options might be considered. In probable order of popularity, these are a distribution transformers fed by a national or regional grid, a diesel/gasoline generating set (genset), a micro-hydropower plant, a wind turbine, and a solar PV (photovoltaic) station. While the purpose of this guide is not to provide details about these various technological options, brief descriptions of issues that should be considered with each option are reviewed.

### ***Grid extension***

In cases where a MV line serving a number of larger load centers passes near a community, this is generally the cheapest approach to rural electrification. Electrification involves the local utility installing a distribution transformer of appropriate size near or in the village and making power available to the village. Presumably the utility is not interested in managing a small system within the community; otherwise, there would be no need for the villagers to consider implementing their own system. In this case, the utility may only be willing to install an energy meter at the transformer location and provide a connection from which the villagers can extend the line into their community under appropriate supervision and implement their own distribution system. The community would then be responsible for collecting the necessary tariff to pay the utility, based on the consumption that has been metered at the transformer.

Several advantages are associated with this option:

- Unless the electricity supply in a country is power-limited, much more power could be made available at the village level than would be the case with the other options. Electrification could therefore have a much broader impact on the community, far beyond lighting and entertainment. With grid extension, employment generation and a much broader range of productive uses of electricity and social amenities are possible on a 24-hour basis.
- In implementing a project, the community has one less burden to address—the power supply. In this case, the national utility would usually ensure a functioning supply of electricity.
- Because of economies of scale in centralized generation, the cost of energy is relatively low. (However, the community may also have to include the cost of bringing the power to the village in the overall project cost.)

The disadvantages associated with this options are the following:

- Some countries do not have a reliable supply. In this case, rural areas are usually the first to be cut off when the load on the entire system exceeds available generation capacity. An unreliable supply may then frustrate consumers who subsequently refuse to pay because of the poor service they receive. The system may then fall apart because of the lack of adequate revenues.
- If more conventional, urban-based, higher-cost design standards to which the utility subscribes must be adhered to, the distribution design adopted in this case may be more costly than would otherwise be the case.

In considering this option, several questions must be asked:

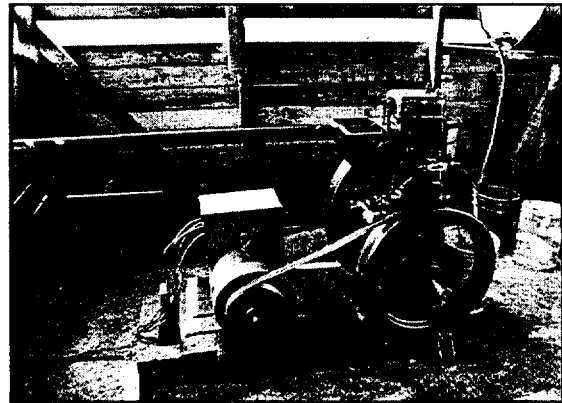
- Is the existing MV line sufficiently close to the community or must it be extended. Is the utility amenable to extending the line and what would be the cost for line extension and transformer placement?
- Are there provisions whereby the utility could enter into some agreement with communities willing to be responsible for their own distribution system?
- Based on experience to date, how reliable can the power supply be expected to be and is that adequate to meet the needs of the community?

In the Philippines, such an approach is routine. Within remote communities, utilities actually install the entire distribution system, with service connections and, through a memorandum of understanding, delegate the responsibility for the metering, billing, and collection to formally formed community groups. The utility merely reads the meters at the transformers it installed in the various community and the community is responsible for collecting the fees and paying its bill.

### ***Diesel/gasoline genset***

Next to connecting to a grid-connected transformer, the use of gensets is the easiest approach to implement. Advantages of this technology are significant: gensets are readily available in all countries and they are low-cost and easy to transport and install (Fig. 5). But several disadvantages must be taken into consideration:

- Fuel must be delivered to the community on a year-around basis (unless it is stockpiled in the community). Can availability of fuel in the community be guaranteed in light of the reliability of transportation, accessibility by road during the rainy seasons, and political uncertainties?
- While the cost of fuel continues to be relatively low, are there any indications that cost will rise significantly or that supply will diminish sufficiently to discourage future use of this fuel?
- Gensets require expertise for regular engine maintenance and, occasionally, major overhauls. A local source of expertise must be available in or to the community before this option is considered. Without this intervention, the life of the equipment may be short and may lead to frequent and costly replacement of equipment.
- Can environmental pollution commonly associated with internal combustion engines—noise, disposal of spent oil, and exhaust emissions—be adequately addressed?



**Fig. 5. A low-speed 6 kVA diesel genset in southern Belize.**

While the availability of fuel and its cost may be of concern, it is interesting to note that diesel fuel or kerosene is already burned in wick lamps as a principal source of lighting in rural homes in many countries. Therefore, in these countries, fuel is already being purchased and imported into communities for lighting. Because burning fuel in a wick lamp for lighting is very inefficient, reliance on a diesel genset for electric lighting means that less fuel would need to be imported into a community to generate the same amount of lighting as the wick lamps currently use.

Another concern might be that diesel gensets generate carbon dioxide, a gas which is generally thought to contribute to global warming and its adverse impacts on the world environment. First, it should be recognized that the quantity of carbon dioxide generated by isolated grids for village electrification is insignificant in comparison to that generated by a country's industrial or transportation sector or by its large powerplants supplying the urban areas. If the reduction of carbon dioxide emissions is truly of concern, it is in these areas that efforts can be cost-effectively focused, not in off-grid electrification. However, at the same time, it should be noted that the introduction of diesel gensets for lighting in areas where wick lamps are being used can actually reduce carbon dioxide emissions.\*

### **Hydropower plant**

All power systems harnessing renewable energy resources (wind, solar, and waterpower) have the advantage of low energy costs. However, the renewable resource with the lowest capital cost (cost per kilowatt installed) and possibly the only resource that can generate significant amounts of electricity on a

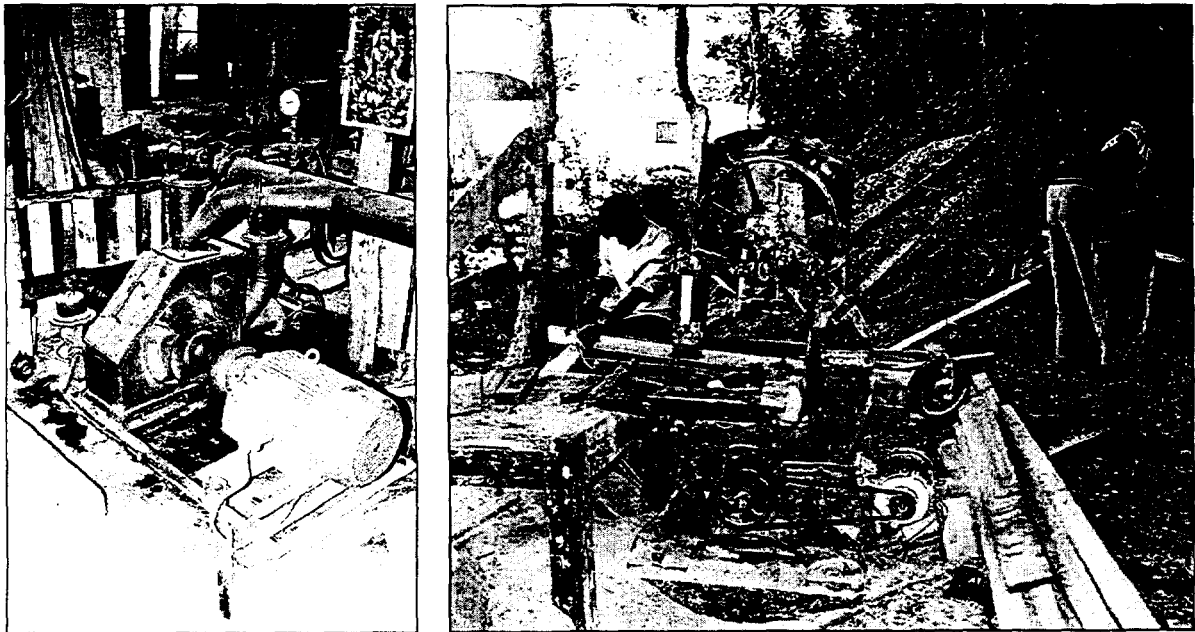
---

\* For example, a typical wick lamp with glass mantel burns fuel at the rate of about 0.04 liters/hour and produces about 50 lumens. On the other hand, even relying on a very inefficient diesel genset (generating electricity at 1 kWh/liter rather than the 2 kWh/liter that is more typical for a small genset), a fluorescent unit (lamp and ballast) rated at about 10 W would consume only 0.01 liters/hour and produce about 400 lumens. So in this comparison, burning fuel in a genset produces 8 times the light, consumes fuel at the rate of one-quarter that consumed by a wick lamp (therefore emitting only one quarter the carbon dioxide), and keeps the emissions from combustion outside the home, reducing any respiratory problems that might be caused by one's proximity to wick lanterns in the home.

24-hour basis to feed into a mini-grid is waterpower. But having said this, the capital or up-front cost is still high. While the cost of a diesel genset might run several hundred dollars per kilowatt, the cost of a micro-hydropower plant (the equipment, powerhouse, and civil works) is usually five to ten times greater (\$2,000 to \$4,000 per kilowatt). Consequently, for such a plant to be viable, it is necessary to ensure that a significant portion of the available power is used for income-generating purposes (i.e., resulting in a high load factor). Otherwise, the plant will not generate the revenue required to cover this increased cost (Fig. 6).

One design option to reduce the cost of the micro-hydropower option is to share the cost of the civil works and the penstock (pressure pipe) with other uses for the water, such as irrigation or, occasionally, water supply. As noted in the case study of the project in the Dominican Republic, for example, the lengthy pipeline was initially purchased to bring water to the village for irrigation. It was this irrigation project that bore the cost of the pipe, resulting in an insignificant additional cost for the hydropower plant (p. 219). This was not possible in the plant in Youngsu, and in this case, the cost of the hydropower plant was a major contributor to total project costs (p. 209).

However, it should be noted that if several types of water projects are to be integrated to save costs, this must be known at the design stage. For example, the diameter of a pipeline designed only to supply a potable water system would normally be much smaller in diameter than one designed for a micro-hydropower plant. This results because a potable-water-supply pipeline usually handles a much lower flow and/or because excess water pressure is not needed to operate the system and can be dissipated in a small pipe. A micro-hydropower plant requires a large diameter to minimize energy loss through friction. If a pipeline is to be used for both purposes, a large diameter pipeline would be required at the outset; it is



**Fig. 6.** This locally manufactured 14 kW micro-hydropower plant in Gotikhel generates power for about 110 households during the nighttime hours for a fee of \$0.40 /month for a 25 W bulb. During the day, it can run a range of electrical equipment, including a bandsaw and planer, as well as a mechanically-driven oil expeller. While electricity is an attractive product, it is the mechanically-driven oil expeller which generates most of the plant's income.



- The location of the resource determines the placement of the powerplant and, with hydropower, the distance between this location and the load may be considerable. Additional costs would be incurred in transmitting power over this distance, adding to the cost of the project. The powerhouse must also be easily accessible at all times to ensure proper operation.
- The availability of the water resource—the streamflow—is subject to the vagaries of the weather. In countries with monsoons or pronounced rainy seasons, it is quite possible to have insufficient water for power generation for nearly half the year. The question that will then have to be asked is whether half a year of guaranteed power is sufficient to justify the project. If the plant can only be used for half the year, then the cost of energy to cover costs must be roughly twice as high.

Storing water originating during the rainy season for use in the dry season is only an option with large hydropower plants. However, small but sufficient streamflow might be available during the dry season for daily storage, such as for storing water during the late evening and daytime hours for use during several hours in the early evening. But this is only an option with higher-head sites with low energy demand. Furthermore, constructing storage capacity can increase cost considerably and create additional operations and maintenance problems.

### ***Wind turbine***

Like hydropower plants, wind turbines must be located where the resource is found. In the case of wind, this may mean on ridges and hilltops, while communities are usually found lower down the slopes or in the valleys. At other times, it may be on the coast, even within a community. But before such an option is adopted, it is necessary to ensure that the wind regime is adequate, both in terms of wind speed and in terms of its availability over the day and over the year. The turbine, tower, battery bank, and electronics are costlier yet than the previous options, on the order of \$6,000/kW for units in the 5 to 10 kW range.

Because of the variability of the energy typically associated with wind turbine, other costs are imposed on this option:

- Possibly the most significant problem with relying on the wind resource is that, since adequate wind speeds are not always present, energy generated when little use is made of the electricity has to be stored in a battery until it is needed. This battery bank needed to store energy adds considerably cost to the initial as well as recurring cost of such a system. Also required are electronics for battery charging and an inverter to convert the stored dc power into ac power as needed, so that it can then be distributed over the mini-grid to the consumers.
- Because of the limited availability of energy, a special electrical meter is required in the home to limit the energy (kWh) which each household can consume daily. If this were not included, it would be possible for a few households to consume the entire day's allotment of stored energy before the others can access their share. These meters are not commonly available and introduce a further cost to this option. Current limiters, such as a simple fuse, cannot be used for this purpose, because these limit current or power (kW) to the consumers but do not adequately limit the energy (kWh) that they consume over the day.

And, as in the case with hydropower, a knowledgeable individual is needed, but this time to ensure proper measurement of the wind resource. This usually requires the collection of data for at least one year before making a decision. Data already gathered in the immediate vicinity should give some indication of this resource but care must be exercised in extrapolating the results because windpower is sensitive to the local topography.

### **Solar PV station**

A solar-PV-based system supplying a mini-grid would generate electricity and store it in a battery bank in a central location and then automatically invert it to alternating current (ac) when it is needed by the grid to supply consumers.

Solar energy has an advantage over the other renewable options in that this resource is more evenly distributed throughout the world. Furthermore, the amount of solar energy reaching a specific point on the earth over the year—the insolation—is known with a greater certainty than are wind or hydropower resources. Therefore, a year of data collection is not required to assess the extent of the resource before committing to a solar system. However, in areas such as those where burning rice stubble in the field or slash-and-burn agriculture creates a heavy haze for a month or two each year or in the mountains where fog typically persists until late morning, one has to be cautious about predictions on insolation based on other areas in the country that may not encounter these conditions.

The principal drawback to solar power for mini-grid application is that this option relies on considerably costlier hardware to harness this energy and make it usable. A complete power supply, with batteries, electronic controls, inverters, etc., costs at least \$10,000 per peak kilowatt. This is equivalent to roughly \$60,000 per "real" kilowatt, i.e., a kilowatt that generates 24 kWh daily.\*

Another significant drawback is the fact that solar-PV generated electricity is direct current (dc) and, like windpower, must be stored in this form in a costly battery bank until it is needed. In addition to the capital costs, these battery banks need to be replaced periodically. For example, a 3-kW<sub>p</sub> solar array that might generate 10 kWh daily would require a 30–40 kWh bank of deep-discharge batteries costing at least \$4,000 and having to be replaced every 5 to 10 years. As with windpower, an inverter is also required to convert dc power to usable ac power when needed by the grid, adding further to cost and complexity.

And as with a wind system, where a limited quantity of energy is generated daily, an electronic metering device would also be required with a solar-based system to ensure that this energy is equitably available to all consumers. Some research and development work on such a device has been undertaken. This device is designed to be located in individual homes and measure energy (kWh or Wh) consumed in the household. In this sense, it is similar to a prepayment meter (see p. 186). However, unlike prepayment meters used on national-grid-supplied systems that can supply an essentially unlimited amount of power and energy, photovoltaic systems have a limit on the energy that can be generated and used each day. Consequently, this device allows only a preset amount of energy to be used daily. It shuts off electricity to the home for the remainder of the day once the limit has been reached. This device automatically resets at the beginning of every evening.

Because of these added costs, solar energy is usually not generated for distribution over a mini-grid. Rather individual solar home systems (SHSs: panel, battery, and electronics) are sold for use in individual homes where electricity is generated, stored, and consumed as dc power, doing away with the need for a grid, inverter, and any kWh-limiting devices. The only advantage of a solar-PV-based mini-grid over a project relying on solar home systems would be that use of a mini-grid permits energy not used by one household to be used by others. But this is rarely, if ever, sufficient rationale for such a system, because this benefit does not justify the added expense of a grid.

---

\* A PV solar system rated at 1 kW (peak) would yield roughly 4 kWh daily. However, a hydropower plant or diesel genset rated at 1 kW could yield 24 kWh daily. For a community to get access to the equivalent amount of energy (i.e., 24 kWh), the PV option would have about six times the capacity noted above or 6 kW. Consequently, in terms of "real" energy generated, the solar option would cost six times its cost per kW (peak).

## Plan of action

Only after all three conditions noted in the first part of this chapter—villager ability to pay, presence of a committed organization and motivated leadership, and availability of a power supply—have been determined not to pose any obstacles to the implementation of a mini-grid should design work be initiated.

At the beginning of all real-world projects, there is a myriad of unanswered questions. Therefore, assumptions must initially be made. For example, the community power demand must be known before the capacity of the powerplant can be selected and the conductor sizes established. However, the community demand depends in part on the cost of the electricity, and this is not precisely known until after the powerplant and conductor have been sized and costs calculated. Therefore, to begin, a cost must be assumed based as much as possible on past experience. Then the project can be sized according to this estimated demand, and a project price then calculated. With this information in hand, one can then establish a tariff and go back to the consumers to determine how this better cost estimate of cost will affect their consumption. Such an iterative process will occur numerous times throughout a project. As more experience is gained, the better will be the assumptions made.

The two lists below itemize the steps required to design and construct a mini-grid after the three preconditions described above have been satisfied. It describes in summary fashion each task to be addressed and refers to appropriate sections in the text that provide additional design and construction details. However, as explained above, some tasks listed in the table cannot be completed until later in the design process. In these cases, approximate values must be assumed and will have to be revised as the design process proceeds.

Mini-Grid Design Tasks	Reference Sections
1. A community-wide meeting should be held to clearly and carefully present the electricity use options and constraints imposed on end-uses by the supply and estimated cost of electricity. This should be followed by a survey of potential consumers about their initial level of expected demand, a realistic projection of growth, and the type of service (i.e., whether and where three-phase distribution is necessary). Type of power supply and voltage level should be identified.	See "Demand assessment" (p. 44). Those assessing demand must have a understanding of the various end-uses and their implications for project design.
2. Estimate an initial tariff structure based on an estimate of project-specific costs and proposed consumption patterns. If this leads to a tariff which is not affordable, the implication on this project feasibility should be considered and alternative design options considered.	"Metering" (p. 154) describes various metering options which may affect how the tariff is set and "Tariffs" (p. 179) describes how a tariff is established.
3. Prepare map of area to be served, locate powerhouse, lay out distribution system, determine locations of loads, and include tentative pole locations.	See "Mapping and system layout" (p. 49)



<b>Mini-Grid Design Tasks (cont.)</b>	<b>Reference Sections</b>
4. Determine the line configuration—single-phase, split-phase, or three-phase—required to serve the expected load.	See “Line configuration” (p. 54)
5. Calculate size and cost of the main conductor to serve design demand for the different configurations. Finalize selection of configuration and conductor size. Modify layout (Item 3 above) if necessary to minimize required size of conductor if possible.	See “Conductor” (p. 64)
6. Establish minimum line-to-ground clearance.	See “Clearance requirements” (p. 98)
7. Assess pole options that are available and which satisfy clearance and strength requirements.	See “Poles “ (p. 86)
8. Select poletop hardware to be used.	See “Poletop hardware and connectors” (p. 105)
9. Design pole guys and anchors where required.	See “Guys and anchors” (p. 117)
10. Based on level of services to be used by each consumer, determine level of protection and housewiring configuration to be adopted.	See “Protecting people” (p. 133) and “Housewiring” (p. 163)
11. Determine what metering is consistent with encouraging the desired load profile.	See “Metering” (p. 154)
12. Select conductor type and size for the service drop.	See “Service drop” (p. 146)

<b>Mini-Grid Construction Tasks</b>	<b>Reference Sections</b>
1. Procure local and purchased materials.	
2. Stake pole positions.	See “Locating poles” (p. 53)
3. Frame poles (i.e., prepare poletop and install poletop hardware) and set them.	See “Setting poles” (p. 103)
4. Prepare anchors and guy poles as needed.	See “Guys and anchors” (p. 117)
5. Install grounding electrodes, as required.	See “Grounding” (p. 123)
6. String, sag, and tie line conductors and add lightning arresters where necessary.	See “Stringing and sagging the conductor” (p. 77) and then “Lightning protection” (p. 141)
7. String, sag, deadend, and connect service drops. Install poles or other line supports as required to maintain adequate clearance.	See “Service drop”, p. 146.

Mini-Grid Construction Tasks (cont.)	Reference Sections
8. Install distribution board, housewiring, light points, power points, ground electrode, breakers, GFCI, etc. as required.	See "Housewiring", p. 163 and "Grounding", p. 123.
9. Inspect and check house circuits.	
10. Connect service entrance conductor to distribution board.	

## IV. Electricity uses and demand assessment

---

This chapter will first review typical end-uses to which electricity can be put and the constraints that a mini-grid might place on the type and size of these uses. How does the fact that the generation capacity of isolated mini-grids is limited affect the types of end-uses that can be used? What impact does the voltage variation commonly found on isolated mini-grids have on end-uses? Is three-phase power necessary for some end-uses or is single-phase power adequate?

After this chapter reviews the end-uses that a mini-grid might supply in a specific community, it will continue by providing guidelines for assessing potential consumer demand so that a mini-grid can be appropriately sized for the expected loads. This step is critical to the success of a mini-grid project because the mini-grid design adopted has a significant impact on project cost. Unnecessarily oversizing a mini-grid increases the cost that the community must cover. Undersizing it will lead to consumer frustration and dissatisfaction with service quality, a dissatisfaction that can easily lead to the loss of consumers and the inability of the remaining consumers to cover costs.

### Types of uses

#### *Lighting*

Two basic types of lighting are commonly used: incandescent and fluorescent lighting. Incandescent lighting relies on passing so much electric current through a resistive filament that it heats and glows, emitting visible light in the process. Fluorescent lighting relies on the passage of electric current through a conducting gas, exciting that gas and forcing it to release light in the process. The light is largely invisible, ultraviolet light, which is absorbed by the white coating on the inside of the tube (phosphors), causing it to glow and emit visible light. Each of these two types of lighting has significantly different characteristics.<sup>2</sup>

#### **Incandescent lighting**

Incandescent bulbs typically used in the home range up to about 100 W and are popular with most rural consumers with limited means because both the fixtures and the bulbs are low-cost. The working life of bulbs manufactured in industrialized nations with quality control typically range from 700 to 1,000 hours when used at their rated voltage. Their luminous efficacy is in the range of 8 to 18 lumens/W.

In comparison to fluorescent lamps, incandescent bulbs produce light inefficiently, converting roughly 10 % of the energy to light and radiating the remainder as heat into the environment. To produce the same light output, an incandescent bulb consumes about four times the power consumed by a fluorescent unit (i.e., lamp and ballast), at four times the cost. Furthermore, while individual incandescent bulbs are less expensive than fluorescent lamps, their shorter life means a higher life-cycle cost. As can be seen in Table 1, the life-cycle cost of incandescent lighting is considerably greater than that of the alternatives. As is covered in the next section, if there is a need to provide electricity at least cost to a community, promoting the use of fluorescent tubes would be advantageous.

The life of the incandescent bulb in Table 1 assumes it is operated at nominal voltage, because the life of a bulb is heavily dependent on its operating voltage (Fig. 8).<sup>3</sup> The lamp cost/hour noted would differ somewhat at other voltages. For example, operating the bulb below its nominal voltage can significantly increase its life, reducing its cost on a per-hour basis. But with an overvoltage of only 8 %, bulb life is

**Table 1. A comparative life-cycle costing of lighting. The light output from the different options is roughly the same. A cost of energy of \$0.10/kWh is assumed.**

	Incandescent bulb	Fluorescent lamp	Compact Fluorescent Lamp
Life (hours)	750	6000	9000
Demand (W)	100	20	20
Cost of lamp	\$0.40	\$2.00	\$20.00
Lamp cost/hour	\$0.0005	\$0.0003	\$0.0022
Cost of energy used over its life	\$7.50	\$12.00	\$18.00
Total cost/hour	\$0.0105	\$0.0023	\$0.0042

reduced by half, doubling this cost. However, because the cost of incandescent bulbs is low (\$0.0005/hour), its reduced life has little affect on the total cost of using that light (\$0.0105/hour). Rather, the largest drawback of operating at an overvoltage is the hassle of frequently purchasing and replacing the bulb.

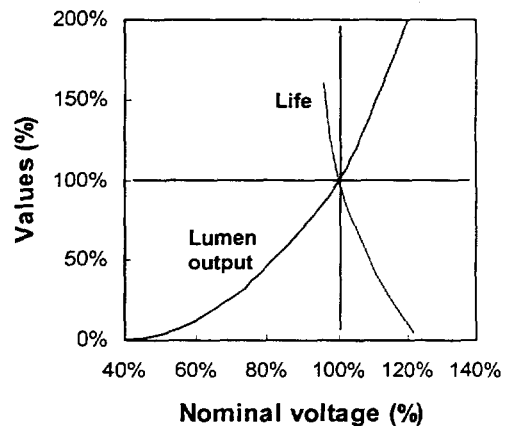
Another drawback of incandescent bulbs is that their light output is also strongly influenced by their operating voltage. Excessive voltage drops along a distribution line can result in significantly reduced lighting levels, giving rise to consumer dissatisfaction. A 10 % drop in voltage can result in a 30 % reduction in the light output.

### Fluorescent lighting

Fluorescent lighting is available in two forms: the conventional straight tube and the compact fluorescent light (CFL). The principal attractive feature of this type of lighting is its high efficiency, generating considerably more light (40 to 80 lumens/W) than incandescent bulbs (8 to 18 lumens/W). This type of lighting has been especially popular this past decade for solar photovoltaic systems because it permits about a four- to five-fold increase in the light output for the same energy consumption. Efficient use of solar electricity is essential if maximum use is to be made of the costly energy generated by this method.

On the other hand, when more and lower-cost power is available, such as with national or mini-grid systems, fluorescent lighting has been less popular because of higher up-front costs and, in some cases, the limited availability of tubes. But especially in the case of mini-grids, it might be in the interest of both the consumers and the supplier to encourage the use of fluorescent lighting. By so doing, a greater number of consumers can be served by the same investment in the power supply and mini-grid and for the same fuel consumption. This can generate additional revenues for the owner and/or reduce the cost to the consumers. Or each consumer can benefit from more lighting at the same cost.

Because of these advantages associated with the use of more efficient fluorescent lighting, consumers should be encouraged to use this form of lighting. However, there are circumstances when the



**Fig. 8. Changes in characteristics of incandescent bulbs with variation in voltage.**

consumers' disposable income is low and the difference in the initial cost between an incandescent bulb and fluorescent lamp is significant enough for consumers to purchase the less expensive incandescent bulb with its lower up-front cost. Or they may not realize that the fluorescent lamp is a less expensive option over time. As can be seen in Table 1, the unit cost of fluorescent lighting on a life-cycle basis (\$0.0023/hour) is only 20 % of the cost of incandescent lighting (\$0.0105/hour).

In addition to the lower cost of fluorescent lighting, the cost of the lamp itself over its long life is negligible. The same table shows that the relatively high cost of the fluorescent lamp (\$2.00) contributes little to the cost of lighting (\$0.0003/hour) when compared to the cost of the energy consumed (\$0.0020/hour) by that same lamp. Because the capital cost of the lamp is so small in comparison to the costs of operating the lamp over its life, it might be advantageous for the electricity system owner to encourage the use of fluorescent lamps by covering the capital cost for providing fluorescent lamps (and possibly even fixtures) to all consumers. This small additional cost could even be recouped over time through a slightly increased tariff.

By being responsible for supplying the lighting hardware, the owner could also ensure the installation of quality lighting components, including the use of fluorescent lamps with power-factor correction (p. 32). This would broaden the benefits that the mini-grid could provide to both the consumers and plant owner.

It might be argued that a larger consumer base would probably result if up-front connection costs (costs of the service connection, housewiring, and lights) to the consumer are minimized by amortizing all these costs in the tariff. However, a more useful indication of real consumer interest in electrification would probably be obtained by requiring them to pay a portion of the cost that is large enough to indicate their commitment to electrification and their ability to find the necessary financial resources. Being forced to cover a portion of the connection cost up front will also more likely ensure that consumers have considered the implications of their proposed consumption level with greater care. The larger their consumption level, the greater would be the connection cost they would have to cover (because larger conductor, a higher level of protection, and more extensive housewiring would be required). Covering at least a portion of system cost up front also gives the villagers a sense of ownership and is more likely to increase the care they take of the system.

One factor increasing the life-cycle cost of fluorescent lamps is the reduction in life caused by utilizing them frequently for short periods of time. This arises because lamp ignition is the part of the lighting cycle of the lamps that places the largest stress on the lamp (in particular, its filament). If lamps are only used for short periods of time (e.g., in bathrooms or cupboards), an incandescent bulb may be most cost-effective. Also, as with any light, if the glass bulb or tube is not occasionally cleaned for dust, carbon black from cooking fires in the home, and insects that may accumulate, light output will decrease. The bulb should be wiped with a damp cloth and dried, but make sure that the bulb is off and cold before it is removed.

### ***Standard tubes***

Fluorescent tubes typically used in the home range from 4 to 20 W and are available at costs ranging from about \$4 to \$8 each, including fittings. The working life of tubes manufactured in industrialized nations with quality control typically ranges from 5,000 to 8,000 hours. Reducing tube diameter can significantly increase light output, and this is the direction in which designs have been heading.

Commonly used fluorescent lamps rely on a glow-type starter and a magnetic choke (a wire coil wrapped on an iron core) that serves as the ballast. The operation of such a design is explained in Box 1. Use of a

### Box 1. Operation of a fluorescent lamp.

A comparison of the operation of incandescent and fluorescent lighting is shown in Fig. 9. In both cases, an on-off switch is used to place the operating voltage across the light. During the operation of an incandescent light, this voltage appears across a filament, pushing current through it and causing it to glow because of the heat generated. The resistance of the filament restricts the amount of current used.

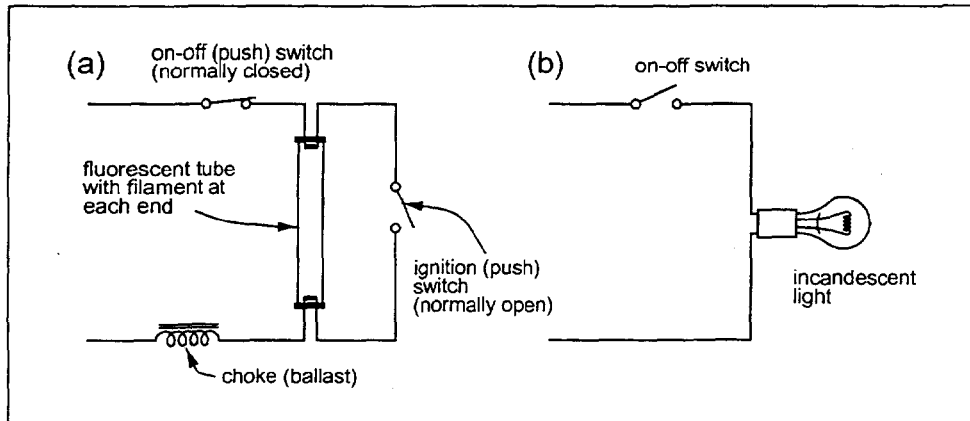


Fig. 9. Comparison of circuits with (a) fluorescent lighting (with manual start) and (b) incandescent lighting.

During the operation of a fluorescent light, current passes through the conducting gas within the lamp from the electrode at one end to that at the other. The current passing through this gas emits light. But two other components are required for its operation:

1. First, the gas in the lamp initially does not conduct electricity. To get it to do so requires the temporary closure of the **ignition switch**. This completes the circuit, permitting current to flow through both filaments that are connected in series. This heats the filaments as in the case of an incandescent light and causes the gas in the vicinity of the filaments to become conducting. However, the resistance of this gas is not yet sufficiently low to conduct electricity and generate light.
2. A **ballast**—a coil of wire wrapped around an iron core—is also required. When the ignition switch is briefly turned on, current flows through the ballast that is in series with the filaments, building up a magnetic field around it. A moment later, after sufficient time has passed for the gas in the vicinity of the filaments to have been heated sufficiently to be conducting, the switch is opened. The sudden stoppage of current through the ballast causes the magnetic field that has built up around the core to collapse, inducing a high voltage peak in the windings. This voltage peak is sufficiently high to force a "spark" to jump across the lamp from the conducting gas in the vicinity of one filament to the other, initiating the flow of current through the lamp.

*(Continued on next page)*

(Continued)

As soon as electricity starts flowing across the lamp, this current further ionizes the gas, causing it to conduct readily and to emit light in the process. But it also causes the resistance across the lamp to suddenly drop. The ballast must now fulfill its second role, limiting the current flowing through the lamp. It provides "resistance" to the flow of current, without the losses of energy associated with the use of a resistor. Without a ballast, the fluorescent lamp would provide little resistance and would cause a short circuit. The only losses of energy in a choke are those caused by (i) heating of the wire in the ballast because of the flow of current and (ii) heating of the iron core caused from flow of eddy currents created by the growing and collapsing magnetic field. This is the source of the wattage losses associated with the use of a ballast and may be several watts.)

With the typical lamp, the ignition switch is not manual but automatic. A bimetallic strip within a small tube replaces the switch (Fig. 10).<sup>iv</sup> When the on-off switch is turned on to light the lamp (Fig. 9a), the voltage appearing between the electrode and a bimetallic strip within this small starter tube causes a gas to glow and get warm, heating the bimetallic strip and causing it to bend and touch the electrode. This turns "on" the switch permitting current to flow through the filaments of the fluorescent lamp. As soon as these touch, there is no more current through the gas within the starter tube. The glowing stops and the bimetallic strip then cools down, disconnecting and turning "off" the switch. This causes the magnetic field in the ballast to collapse, triggering flow of current through the main fluorescent tube as was described previously. This starter switch then stays off because, as soon as the fluorescent lamp starts operating, there is almost not voltage across the lamp and, therefore, no voltage across the glow tube to reheat the gas; it all appears across the ballast.

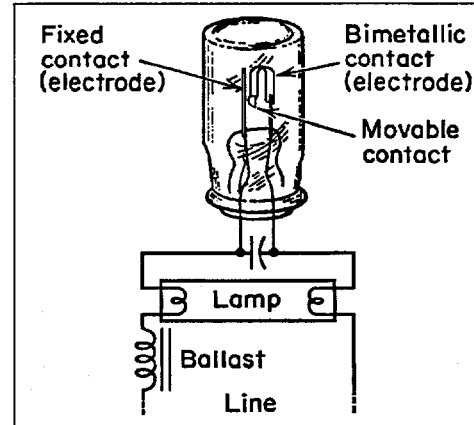


Fig. 10. "Glow" type starter for a fluorescent tube.

choke introduces power (watt) losses in the ballast itself. It also causes the lamp to draw more current from the electricity supply than is really required, making inefficient use of available current and distribution line capacity. This situation can be remedied by adding a capacitor in the circuit for power-factor correction. This is discussed later (p. 4).

More recently, electronic ballasts using solid-state devices have been developed. These supply a high frequency current to the lamp (typically 30,000 Hz rather than 50 or 60 Hz). While costlier and more susceptible to voltage fluctuations, this makes the lamp start quicker; brings the power factor close to unity; eliminates any flickering of the light; reduces noise, reduces ballast losses, and weight; and improves lamp efficiency and life. A 30 % saving in energy for light output comparable to that from a conventional fluorescent lighting is possible. This technology is rapidly becoming standard in fluorescent lighting. Furthermore, if the lamp does not ignite, electrode current ceases to flow. With a magnetic ballast, if the lamp fails to ignite, the glow tube continues to retry igniting the lamp until the lamp is manually switched off. This can damage the starter and ballast.

Low voltage affects the operation of fluorescent lamps. However, unlike incandescent bulbs, the light output from fluorescent lamps is much less sensitive to voltage drops. A 10 % decrease in voltage that will reduce light output from an incandescent bulb by 30 % will reduce the light output from a fluorescent lamp by less than 5 %. But while a fluorescent lamp will continue to operate at 10 to 15 % below nominal rated voltage with no major change in intensity, it will become increasingly difficult to ignite (start). Below this voltage, the lamp will not light. If the lamp is already operating, flickering will be more noticeable as voltage decreases. But if voltage drops more than roughly 25 %, the lamp may well go out. With lamps using magnetic ballasts, any low voltage causes the lamp to lose its gas discharge current. This causes the starter switch to start triggering repeatedly in an attempt to re-ignite the lamp. Repeated restarting damages the filament electrodes at each end, reducing their light and visibly darkening the phosphor coating at the end of the lamp. In designing a distribution system, the design should strive to prevent the maximum drop at the end of each line from exceeding 10 %, even though some lamps might continue working at somewhat lower voltages.

Higher operating voltage or reduced power-line frequency tends to shorten ballast life because of the increased heating associated with the increased currents that these cause.

### ***Compact fluorescent lamps (CFLs)***

Somewhat more than a decade ago, CFLs spearheaded the movement toward wider use of energy efficient lighting. While operating in the same manner as fluorescent lamps and with about the same luminous efficacy, they have the advantage that they can be inserted into a socket for an ordinary incandescent bulb and do not rely on the larger fittings commonly associated with fluorescent lamps. The ballast and electronics are either built into the base of the lamp or are separate and mounted between the bulb socket and the detachable folded-tube assembly of a CFL. A possible disadvantage of lamps with integral electronics in the lamp's base is that they can be costly, in the range of \$10 to \$15. However, exceptions exist. For example, CFLs from China are commonly available in Southeast Asia for as low as \$1.30. Since ballasts have roughly five times (i.e., 50,000 hours) the life of a CFL, it may be more cost-effective to use the modular design with a separate ballast so that an old tube can be replaced without having to also replace the still functional ballast.

### ***Line losses caused by using fluorescent lamps***

Especially for isolated mini-grids where most efficient use must be made of limited generation capacity, the increased efficiency of fluorescent tubes over incandescent bulbs in terms of their light output for a given power rating is attractive. However, the full potential of the advantage cannot be tapped without also ensuring that the power factor associated with the operation of fluorescent tubes has been brought near unity.

The power factor,  $\cos \phi$ , associated with an electric device is a measure of how much the current passing through that device is in phase with the voltage. More practically, it can be regarded as a measure of the efficiency with which the current in a circuit it used. For a purely resistive load, the power factor is unity, i.e., the alternating current is in phase with the voltage driving it. The relationship between the power  $P$  consumed by a device, the current  $I$  through the device, and the voltage  $V$  driving that current is

$$P(W) = E(V) \cdot I(A) \cdot \cos \phi$$

For example, an incandescent lamp is a resistive load and has a unity power factor. If a 40 W incandescent lamp is plugged into a 240 V supply, the current that the line must carry to properly operate the lamp is simply



$$I = \frac{P}{E \cdot \cos \phi} = \frac{40 \text{ W}}{(230 \text{ V})(1.0)} = 0.17 \text{ amperes}$$

The situation may be different with a fluorescent lamp. If the fluorescent unit contains a magnetic ballast that is uncorrected (i.e., has no capacitor included in the circuit), it has certain characteristics which causes it to make inefficient use of the current it draws. For fluorescent lamps with uncorrected magnetic ballasts,  $\cos \phi$  is usually in the range of 0.5 to 0.6 (Fig. 11). For example, if a fluorescent unit has a power factor of 0.5 and were to consume the same "real" power of 40 W, it would require

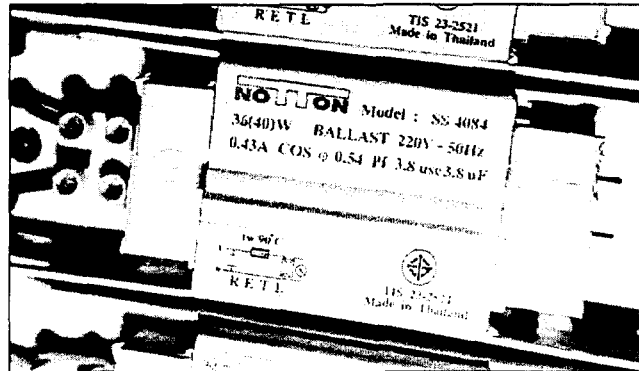


Fig. 11. View of the name plate of a ballast. This name plate indicates the need for a 3.8  $\mu\text{F}$  capacitor to raise the power factor from 0.54 to 1.0.

$$I = \frac{40 \text{ W}}{(230 \text{ V})(0.5)} = 0.34 \text{ A}$$

or twice the current to operate. Requiring this extra current to flow through the distribution line (1) increases voltage drops and losses along that line and (2) limits further the load that can be served by a given generator. The following example illustrates these two drawbacks and how they can be resolved.

For this example, assume that a single-phase distribution line stretches 1000 m from the power supply to the last house and that 50 households are evenly distributed along that line, with each consumer using 40 W. This loading represents a total demand of 2.0 kW along the line, which, for the purpose of calculating the voltage drop at the end of the line, is equivalent to a single load of 1.0 kW at the end of the line. Let it also be assumed that the maximum voltage drop should not exceed 6%. The following operating characteristics for this section of the ACSR mini-grid can be calculated using the equations on p. 75.

For this example, the first row of Table 2 indicates that a 21-mm<sup>2</sup> ACSR single-phase line can supply power to light fifty 40-W incandescent lamps distributed along the section of line with an acceptable 5.3% voltage drop. However, if to get more lighting these are replaced by typical fluorescent lamps with

Table 2. Impact of capacitor correction on cost of line losses.

Scenario	Total current	Conductor size	Voltage drop	Line loss	Conductor cost
Fifty 40-W incandescent lamps	8.5 A	#4 AWG (21 mm <sup>2</sup> )	5.3 %	50 W	\$560
Fifty 40-W fluorescent lamps					
• without capacitor correction	17 A	#4 AWG (21 mm <sup>2</sup> )	8.3 %	210 W	\$560
• without capacitor correction	17 A	#1 AWG (42 mm <sup>2</sup> )	5.5 %	100 W	\$1000
• with capacitor correction	8.5 A	#4 AWG (21 mm <sup>2</sup> )	5.3 %	50 W	\$560

no power-factor correction, the current demand of each light would increase from 0.17 to 0.34 A per light as previously calculated. This would lead to an increased voltage drop of 8.3 % (second row of data). This would also result in increased energy losses along the line. Because the voltage drop is now outside the acceptable limit, the conductor size could be increased to 42 mm<sup>2</sup> to reduce the voltage drop to an acceptable value (third row). However, this roughly doubles the cost of the conductor for that line.

Alternatively, it is possible to modify the fluorescent units so that they use the current more efficiently. This is referred to as power-factor correction and involves placing a capacitor in parallel with each ballast. By choosing the proper value of the capacitor, it is possible to raise the power factor and thereby reduce the current needed to equal that used by the incandescent lamp. With an increased power factor, the previous equation now becomes

$$I = \frac{40 \text{ W}}{(230 \text{ V})(1.0)} = 0.17 \text{ A}$$

In this case, the distribution line with the original conductor size of 21 mm<sup>2</sup> could again be used (fourth row). Now, although the 40-W incandescent bulb and the 40-W fluorescent lamp both consume 40 W and the same current, the advantage of converting to the fluorescent lamps is that roughly four times the light is now available without the need for a distribution line with increased capacity.

The reduced size and cost of a distribution line is not the only benefit that should be considered. The lower voltage drop is an additional benefit. High voltage drops can give rise to operational problems and frustrations—incandescent lamps which glow too dimly, fluorescent lamps which cannot ignite, or motors which blow fuses or trip the breaker repeatedly because the voltage is inadequate to properly start them. Power-factor correction therefore also reduces consumer frustration and operational problems and increases consumer satisfaction with the electricity service.

The previous paragraphs have illustrated how power-factor correction can reduce the size and cost of a distribution line and voltage drop and power losses along that line. This is illustrated in Appendix 7 (p. 232). But there are additional benefits.

If fluorescent lighting is the principal load on a mini-grid, power-factor correction will permit a greater number of households to be served with the same generator. The current output of a generator is limited by the capacity of the wire that makes up the windings to handle that current. A current in excess of the generator's design capacity causes the windings to overheat, damaging the windings or otherwise reducing its life. Therefore, because of this limit, it is necessary to make most efficient use of the current generated. This is illustrated in Box 2 and again in Appendix 7 (p. 232).

#### ***Power-factor correction***

The power factor can be increased by adding the correct amount of capacitance directly at the source of the problem, in this case, across the leads to the fluorescent unit. The value of the capacitor that must be used with each unit to achieve unity power factor is determined by the following equation:

$$C = \frac{I \times \sin \phi}{6.3 \times E \times f}$$

where

**Box 2. Impact of power-factor correction on the usable output of a genset.**

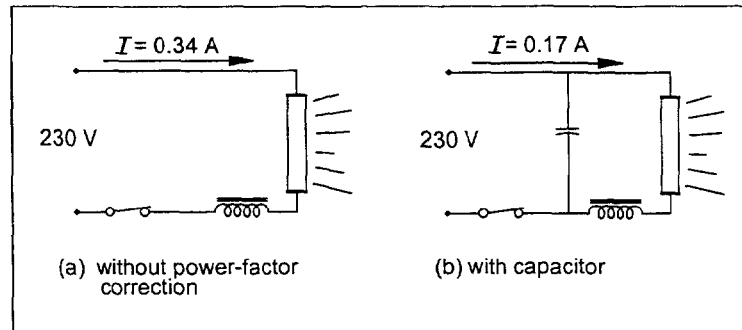
**The problem:** A small gasoline genset that generates single-phase power at 230 V is rated at 3.0 kVA at a power factor ( $\cos \phi$ ) of 0.8.

- (1) Can the genset furnish the current necessary to operate fifty 40-W fluorescent units (only 2.0 kW of load) with an uncorrected power factor of 0.5?
- (2) What impact does increasing power factor to 1.0 have on the number of fluorescent units the same genset can supply?

**The solution:** From the generator specifications and the fact that  $P(\text{VA}) = E(\text{volts}) \times I(\text{amperes})$ , the genset can supply a maximum current of

$$I = \frac{P}{E} = \frac{3000 \text{ VA}}{230 \text{ V}} = 13 \text{ A}$$

- (1) This limit is set by the size of the wire used in the windings. No matter what the load or how efficiently the current is used, the maximum current generated should not exceed 13 A. Since the demand from each uncorrected fluorescent lamps is 0.34 A (Fig. 12) for a total of 17 A (Table 2), this genset has inadequate capacity to satisfy the demand.
- (2) By increasing the power factor and making more efficient use of the current, only 0.17 A is required of each lamp for a total of 8.5 A to satisfy the demand. The genset is now not only able to satisfy the demand but it can also increase the load it can serve by 50 %.



**Fig. 12. With the addition of a capacitor in the circuit to increase the power factor to 1.0, this 40-W fluorescent unit can give the same light for half the current consumption.**

- $C$  = value of capacitor required (farads)
- $E$  = nominal operating voltage
- $f$  = power frequency, usually 50 or 60 hertz (cycles per second)
- $\phi$  = power-factor angle =  $\cos^{-1}(\text{power factor})$

The value of  $I$ , the current in amperes drawn by each unit may be indicated on the nameplate on the fluorescent unit. Alternatively, it is possible to connect up one unit and measure its current consumption.

The calculation for the value of capacitance needed to increase the power factor from 0.5 to 1.0 for the fluorescent unit used in the previous example, is as follows:

$$\begin{aligned} \text{power factor} = \cos \phi &= 0.50 \\ \phi &= 60^\circ \\ \sin \phi &= 0.87 \end{aligned}$$

so that

$$C = \frac{(0.34)(0.87)}{(6.3)(230)(50)} = 0.000004 = 4 \cdot 10^{-6} = 4 \text{ microfarads} = 4 \mu\text{f}$$

In this case, including a capacitance of 4  $\mu\text{f}$  would increase the power factor from 0.5 to 1.0 and reduce current consumption from 0.34 to 0.17 A. Even a capacitance of half this value, 2  $\mu\text{f}$ , would increase the power factor from 0.5 to 0.75 and reduce current consumption 0.34 to 0.22 A.\* The first 2  $\mu\text{f}$  of capacitance is therefore more effective in reducing current draw than the second.

In this example, the capacitor would have to be connected between the input leads of the fluorescent unit. It should be placed on the lamp side of the switch so that the capacitor does not remain in the live circuit when the light is switched off. It should be rated at least at the working voltage (in this case, 230 V, although a higher voltage rating would usually increase its life). Metalized film capacitors for ac applications should be used.

#### ***Is power-factor correction worth it?***

While the inclusion of capacitors to increase the power factor has a number of benefits, the cost of the capacitors themselves would then be incurred. How does the added cost for the capacitors compare with the cost savings?

As an example, assume the previous case in which uncorrected fluorescent lamps are to be used because they benefit the consumers by providing several times the lighting capacity of incandescent bulbs. Furthermore, a single-phase distribution line using a #1 AWG conductor is initially considered to satisfy the requirement of keeping the voltage drop to within 6 %. The alternative being considered is purchasing and installing capacitors which will permit the use of smaller, #4 conductor.

What is the cost of this intervention? In the above case, including fifty 4- $\mu\text{f}$  capacitors would cost about \$200 for materials and some for the labor required for their installation (if the fluorescent units are not purchased already corrected).

The benefits from this interventions are the following:

- Reduced conductor size for the distribution lines. From Table 2, the cost savings obtained by being able to use a smaller conductor is about \$440 up front.
- Reduced energy losses along the line. Table 2 also shows that lines losses would be reduced by 50 W by using capacitors even though the conductor is smaller. What is the cost of generating this energy which is lost through resistive heating of the conductor?

If we assume that the mini-grid and all lights operate a total of 5 hours each day, the additional energy losses in the line each year would equal about 90 kWh. If the fuel costs \$0.50 per liter and the genset generates 2 kWh/liter, the cost of the energy is roughly \$0.25/kWh. Consequently, the cost of lost energy would amount to about \$20 every year.

---

\* Note these latter figures cannot be obtained directly from the previous equations but require more involved calculations, which are beyond the scope of this publication.

- Reduced generator cost. As seen in Box 2, by using power-factor correction, a generator with half the kVA capacity would be required. This is an additional savings that depends on the cost of locally available generators.

All these financial benefits are in addition to increased lighting and improved quality of service from a system which requires no additional fuel consumption.

Planning to only use power-factor-corrected ballasts from the outset permits the construction of a more efficient and therefore less costly supply and mini-grid. If, on the other hand, the system is presently operating with too many fluorescent lamps, the voltage at the end of the line may already appear too low or the capacity of the generator may be inadequate. In this case, fluorescent fixtures in homes already corrected to the grid can be retrofitted with capacitors. This will reduce current demand and subsequent operational problems due to too low a voltage at the end of the line. It may also permit some additional lamps to be connected, without having to replace the conductors or generator with ones of greater capacity.

In summary, power-factor correction can reduce energy losses in the mini-grid, improve operational characteristics of the grid, and permit increased use to be made of existing generating capacity. These benefits should probably convince most that power-factor correction is a worthwhile undertaking when low power-factor uses are prevalent.

So why are fluorescent units frequently sold without the necessary capacitors? By omitting the capacitor, manufacturers are able to noticeably reduce the cost of the unit without affecting the brightness of the lamp. The consumer thereby appears to benefit from the lower cost of the unit because of this omission. However, it is the owner of the mini-grid, which may be the community itself, that loses. Without power-factor correction, the energy losses in the distribution system would increase, the quality of the voltage would decrease, and/or fewer households could be served by the same powerplant.

### ***Entertainment***

Next to lighting, the most popular end-uses for electricity in a village are typically televisions (TVs), radios, and cassette players/recorders. In rural areas off the national or regional grid, these are generally powered by batteries. While the cost of batteries may appear low, this is not the case. Compared to the cost of energy from the national grid (about \$0.10/kWh) or from a diesel-powered mini-grid (at perhaps \$0.40 to \$0.80/kWh but dependent on a large number of factors), electric energy from dry cells costs roughly \$50.00/kWh (but is strongly dependent on the source and age of the batteries). Because of their somewhat larger power demand, TVs are often powered by automobile batteries that are regularly carried to the nearest town for charging. Energy from automotive batteries is also relatively expensive, costing about \$2 to \$3/kWh for battery-charging, transportation costs, and the amortized cost of the battery.

Replacing batteries with ac power from a mini-grid can present a major economic benefit to those consumers who use batteries. This can be achieved in either of two ways. The first is to purchase equipment that can be powered by both batteries as well as ac. Using ac is usually accomplished by using a separate ac/dc converter—an "adapter"—which often comes with the radio or other dc electronic equipment and plugs into a power outlet in the home. Then batteries would only be used when the radio is used away from the outlet.

The second approach is to continue using batteries but to use special rechargeable batteries and a battery charger. This has the additional advantage that it would be possible to power the radio, flashlights, and other devices outside the home or at times the mini-grid is shut down.

- For small batteries for radios and flashlights, the consumer can purchase a battery charger and rechargeable batteries, usually nickel-cadmium (nicad) batteries. The major drawback is that these batteries are considerably more expensive than ordinary batteries. A 1.5-V D-size dry cell might cost \$0.20 each while a similarly sized nicad battery could cost \$6. However, the fact that they can be charged hundreds of times compensates for this shortcoming. If one assumes a life of 300 charging cycles, a charged nicad battery would only cost \$0.02 or about one-tenth the cost of an dry cell of equivalent capacity. To address the high initial cost for rechargeable batteries, renting charged batteries could be a service provided by the village utility or an entrepreneur (see "Consumer services", p. 176).
- Larger, lead/acid automotive batteries might be preferred by those with greater needs (TVs, small power tools, etc.) during times when the grid is off or by those who live outside the area served by the grid. Individual consumers served by the grid might have their own charger for automotive batteries belonging to themselves or possibly to others and have access to an adequate level of power on their premises to charge these batteries. This could also be done by the utility itself—as a service that families pay for—to make better use of the available capacity of a generating plant.

### ***Motor-based applications***

The previously mentioned end-uses—lighting and entertainment—are very attractive and are the most popular initial uses of electricity in most rural settings. However, if a mini-grid project is to pay for itself and to bring increased socio-economic benefits to the community, it often is necessary to judiciously incorporate productive, income-generating uses in the load mix. Many such uses, such as agro-processing equipment, refrigerators, water pumps, and wood and metalworking equipment (Fig. 13), require motors as the source of motive power.

But if such uses are being contemplated at some stage of project development, operational characteristics of motors should be considered at the design stage to ensure that the grid is designed to accommodate such loads:

- Individual motor loads can be larger than any other single load on the system and can be the determining factor in setting the size of the powerplant.
- Motor starting currents are significant and are an important consideration in determining the maximum size motor that may be powered by a mini-grid, in properly sizing of the conductor used for the mini-grid, and in deciding upon the proper layout of the grid in the community, i.e., the placement of the genset with respect to the location of the motor loads.

Motor-starting is a critical period because of the torque required to bring the motor up to speed. During this period, considerable current is required for this purpose, generating heat in the motor windings. The start-up period should be minimized to reduce the heat buildup and adverse impacts this can have on the insulation and, therefore, the life of the generator. Normal start-up will be ensured if the generator and



**Fig. 13. A planer is a popular woodworking handtool powered by a mini-grid.**

the distribution line to the motor have adequate capacity to supply this extra current to the motor while restricting the voltage drop to no more than about 20 % of nominal. If this is not possible, the motor may stall and will likely be damaged. The capability of a generator to start a given motor depends on many factors, including the design and characteristics of the motor, as well as the type of voltage regulator and exciter used by the generator and the characteristics of the line connecting the motor to the generator.

The following pages will first identify the types of loads that a motor may experience. This will be followed by a review of the types of motors that might be used for mini-grid applications to supply those loads. And finally, the calculation of the nominal current drawn by a running motor will be illustrated and the implications of the size of a motor's starting current on the maximum size motor that might be used with a particular generator will be explained.

### **Types of loads**

Once operating under a constant load, motors have current requirements that are approximately proportional to the load they are driving and that are straightforward to calculate (see below). But while a generator might provide more than adequate power to run a motor, it is possible that the same generator and the distribution line between the generator and the motor do not have sufficient capacity to start the motor. The size of the demand placed on the generator during start-up depends on both the nature of the load to be driven and the type of motor used. For this reason, it is useful to categorize end-uses for motors by the type of load they impose on the motor upon starting. Starting loads can be divided into three categories:

1. Applications with low starting torque, such as floor drills and portable tools, food mixers and blenders, and sewing machines. Fans and centrifugal pumps also fit into this category because the load each imposes on the system is small at low starting speeds and only increase as the speed increases.
2. Applications with constant torque, such as air compressors for running tools or filling tires, refrigerators and freezers, conveyor belts, and positive displacement pumps such as gear pumps.
3. Applications with high inertial starting torque, where the large mass attached to the shaft makes it difficult to start it turning. These include some grindstones, grain mills, and woodworking equipment such as bandsaws.

The last two categories represent more difficult loads to serve because of their starting requirements.

### **Types of motors**

The principal types of motors that might be found in a small community are brush type or "universal" motors and induction motors. Universal motors are small—typically 1/20 hp or less—and are used in all types of handheld appliances, such as drills, mixers, blenders, saws, and sewing machines. They are inefficient, noisy, and require maintenance as their brushes wear. However, they are insensitive to the quality of power provided and can operate successfully under extremely adverse conditions of low or fluctuating voltage or variable frequency. They are usually high speed, with the speed dropping rapidly as load increases.

Induction motors are sold as free-standing units to power pumps, air compressors, fans, conveyors, and other machines or are incorporated into larger appliances such as refrigerators. Their speed remains relatively constant as load changes. Induction motors are mechanically rugged, but are sensitive to power quality and may be damaged by prolonged operation at low voltage. They also impose significant burdens on the grid due to their need for extra current during the starting process.

Induction motors are available as single-phase and three-phase motors. Whether a single- or three-phase motor is used to drive a specific piece of equipment is determined by the size of the demand, the cost of the motor, and the type of electric service available. Single-phase motors are available in sizes from fractional horsepower ratings up to approximately 10 hp. Three-phase motors are also available in fractional horsepower ratings, but in sizes below 1 hp are more expensive than single-phase motors. User equipment with a power demand of less than 1 hp is therefore almost always driven by a single-phase motor. Single-phase motors are used to drive smaller appliances, such as hand-held power tools, mixers and blenders, as well as larger equipment, such as water pumps, air compressors, fans, grain mills, and table saws. Single-phase motors larger than 1/3 hp should be capacitor-start types to reduce starting currents and the voltage flicker they cause (see below). Three-phase motors, because of their lower cost and ruggedness, are preferred for all applications over 10 hp and are often used in smaller sizes if three-phase power is available. The cost of extending three-phase service sometimes outweighs the savings in the cost of the motor for applications between 1 and 10 hp.

For typical motor loads that might be found in a small community, single-phase induction motors are usually favored. Table 3 illustrates typical operating characteristics for the three common types of induction motors:

1. Capacitor-run: The limited starting performance of this type of motor makes it most suited to low starting-torque applications which limits its starting current demand. It operates with a high power factor and efficiency. The capacitor is continuously rated and remains in the circuit permanently.
2. Capacitor-start: This motor has a capacitor that is only included in the circuit to improve the power factor, and therefore reduce current demand, during the start-up period. It has a good starting performance. As the motor comes up to speed, a centrifugal switch switches out the capacitor. During its running, the power factor and efficiency are lower because the capacitance is no longer in the circuit.

**Table 3. Sample operating characteristics for a four-pole (about 1400 rpm) single-phase induction motors running on 240 V, 50 Hz.**

Motor type	Size range (kW)	Rating (kW)	Current (A)	Efficiency	Power factor (run mode)	Locked rotor torque (x rated torque)	Locked rotor current ratio (x rated current)	Built-in run capacitor	Built-in start capacitor
Capacitor-run	0.12 - 1.5	.25	1.7	65 %	0.95	3.5	3.5	12 µf	none
		1.1	6.5	72 %	0.98	3.5	3.5	40 µf	none
Capacitor-start	0.12 - 2.2	.75	6.5	67 %	0.72	5.5	5.5	none	130 µf
		2.2	16.5	77 %	0.75	4.5	4.5	none	160 µf
Capacitor-start/run	0.75 - 3.0	1.5	9.0	79 %	0.87	2.0	5.6	30 µf	160/200 µf
		3.0	16.4	80 %	0.93	2.9	5.2	40 µf	200/250 µf



3. Capacitor-start/capacitor-run: This type of motor has a good starting performance and therefore is suitable for high starting-torque applications. It is the most efficient of all single-phase induction motors and is generally used with higher-horsepower single-phase motors. It includes both a temporarily connected start capacitor and a permanently connected run-capacitor.

In the table, the term "locked rotor" used by motor manufacturers refers to the starting condition when initial currents are similar to those one would encounter if the rotor were locked. Note that these currents are from four to six times the nominal running currents. During start-up, the power factor of the motor is usually much lower than it is while running. The inefficient use of current that is implied in a low power factor is one reason for the high currents required. For example, while six times the running current may be drawn on start-up, the starting power may actually only be twice the running power.

It is important that available voltage on the mini-grid be maintained at near its nominal value during start-up. A low voltage reduces the starting ability of a motor. Appliances requiring a high starting torque, such as a refrigerator compressor, are in danger of overheating and not starting under these conditions. With a high current demand, the voltage available at the motor is decreased through voltage drops along the line which supplies the motor if its capacity is inadequate (because it is too long or uses too small a conductor). Ideally, voltage drop during motor starting should be limited to no more than about 5 %. However, if starts are infrequent and thus not likely to cause complaints from other users, voltage drops as high as 20 % at the motor terminals during starting can be tolerated. For these reasons, motors of any significance should preferably be sited near the powerplant and, if possible, supplied by a separate circuit. This will provide maximum voltage to the motor and will also reduce voltage drop witnessed by the consumers along the remainder of the line. Since there will still be a voltage dip when the motor starts, the frequency of this starting and the annoyance it may cause other consumers (usually through fluctuating light intensity) should be kept in mind when laying out the distribution system.

### **Motor and line sizing**

#### ***Running current***

A motor is normally rated and labeled by the maximum continuous shaft or mechanical output power it has available to drive the equipment to which it is connected. This is measured in horsepower (hp). The actual power it delivers will depend upon the load imposed by the equipment it drives and is equal to or less than the rated power. The relationship between the output power of a motor and the power it consumes (input power) is given by the following relationships:

$$P_i (\text{VA}) = \frac{P_i (\text{W})}{\cos \phi} = \frac{P_o (\text{W})}{\eta \times \cos \phi} = \frac{P_o (\text{hp}) \times 750}{\eta \times \cos \phi}$$

where

$\cos \phi$  = power factor

$\eta$  = efficiency of the motor

$P_i$  = input power

$P_o$  = output power available for driving equipment (expressed in either watts or horsepower, with the conversion factor, 1.0 hp = 750 W)

For example, assume that a flour mill requires a motor with 3 hp (2.3 kW) of shaft power to run at capacity. A 4-hp motor is found and the motor manufacturer indicates its efficiency as 70 %, with a power factor of 0.75 when running. The motor's electricity demand while driving the flour mill would be

$$P_i(\text{VA}) = \frac{3 \times 750}{0.70 \times 0.75} = 4300 \text{ VA} = 4.3 \text{ kVA}$$

If a single-phase motor running off a 230-V supply were used, the steady-state current drawn from the mini-grid would be

$$I = \frac{P_i(\text{VA})}{E} = \frac{4300 \text{ VA}}{230 \text{ V}} = 19 \text{ A}$$

where  $E$  is the voltage imposed across the motor.

If a three-phase motor running off a 230/400 V supply were used, the steady-state current drawn from the mini-grid would be

$$I = \frac{P_i(\text{VA})}{3E} = \frac{4300 \text{ VA}}{690 \text{ V}} = 6.2 \text{ A}$$

where  $E$  represents the phase-to-neutral voltage (see Fig. 15c).

By knowing the nominal running current associated with a motor and the factor by which this is increased during start-up, as noted in Table 3, it is possible to size the line conductors between the generator and the motor to keep voltage drop during start-up to within acceptable limits (such as no more than the 20 % noted on the previous page). An example can be found in Appendix 7 (see p. 237).

#### ***Maximum limit on motor size***

For a system supplied by a synchronous generator, which is typically the case with a mini-grid, motor-starting capability will depend on the size of the generator and its design, particularly on the design of the voltage regulation and excitation system. A good quality synchronous generator will be fitted with an automatic voltage regulator (AVR) that will maintain the output voltage under motor starting conditions by circuitry that can boost the field current for several seconds. This can help supply the high starting current requirements (up to six times nominal running current) of motors used for high starting-torque loads. Because of the greater starting torque possible, synchronous generators should be selected where motor loads are likely.

For direct motor starting, the maximum limit on motor capacity (measured in hp) typically is numerically equal to 15 % of the capacity of the generator (measured in kW). If a high quality motor is used, current should be no more than about four times nominal and the maximum motor capacity may be up to twice this value.

To reduce the cost of the generator, lower-cost induction motors connected to some capacitors with the necessary electronics occasionally serve as induction generators for use in isolated locations. These have become increasingly popular with micro-hydropower plants that capitalize on the lower cost and increased robustness associated with the simpler construction of induction motors.

For systems supplied by such induction generators, motor-starting capability is less than systems supplied by synchronous generators because the design on induction generation precludes the possibility of increasing the field current as is possible with synchronous generators. For a motor starting on a line supplied by an induction generator, the maximum limit on motor capacity (measured in hp) typically is

numerically equal to 5-10 % of the capacity of the generator (measured in kW). In practice, higher-capacity motors than this can often be started, provided that the required starting torque is low. But significant voltage dips can occur.

The limits on the size of motors above are valid for both single-phase motors driven by single-phase generators and three-phase motors driven by three-phase generators. Another case is where single-phase motors are driven off three-phase generators. In this case, if the generator and distribution line are delta (three-wire) connected, the maximum limit on motor capacity (measured in hp) is again numerically equal to about 15 % the capacity of the generator (measured in kW). If the generator and distribution line are wye (four-wire) connected, the maximum limit on motors capacity is about half this value.

While the primary concern above is maintaining a sufficiently high voltage at the motor to ensure its proper operation, too high a voltage (over 10 % above nominal) can also damage motors because of the higher currents associated with the higher voltage. High frequencies can cause problems with motors requiring a high starting torque. If the supply frequency is as much as 10 % above the nominal frequency, the steady-state motor speed would be correspondingly higher and the additional torque requirements to get up to this higher speed can be sufficient for the motor to fail to start altogether. Any voltage drop in the line from the power supply to the load further exacerbates this problem. This reinforces the argument for placing motors as close to the generator as possible.

Over-frequency can also affect some motors in the running mode. When driving certain loads, such as centrifugal pumps and fans, the higher frequency implies a high motor speed that in turn implies an increased load (since load is proportional to the square or cube of the speed). This results in an excessive current, which can lead to overheating and possible burn-out. The frequency rise should not exceed 10 %.

#### **Mechanical-drive alternative for large motors**

As explained earlier, a mini-grid that relies on its own small power supply may have a difficult time supplying large motors. For example, a 7 kW village genset that serves the lighting needs of 50 families in the evening cannot be used to drive a 4-hp rice mill even during the day because the generator has insufficient power to start the motor. For this reason, end-uses which depend on motors can be considered to be in either of two broad categories: those which require fractional horsepower motors which easily can be run by a small powerplant (hand drill and saws, blenders, fans, sewing machines, some pumps, refrigerators, etc.) and motors (for grain mills, rice hullers, table saws, etc.) which are too large to be powered by a small powerplant.

For motors driving the first set of end-uses, a mini-grid can power them, provided that the supply has sufficient capacity, as noted earlier. For motors driving the second set of end-uses, this may not be the case. But even in this case, an alternative solution may exist. This would be to select a prime mover (e.g., a diesel engine or hydropower plant) to directly drive this equipment, usually by means of flat or vee belts. Actually, this is often how electricity is introduced into a community. An entrepreneur first purchases a diesel engine to drive his rice or grain mill. Then, perhaps as an afterthought, he or she considers the possibility of also generating electricity as an additional source of income and providing a service to the community as well.

Even when a generator is already installed to provide electricity to community households, using the prime mover (the engine) to directly (i.e., mechanically) drive the end-use equipment would still have several important advantages.

- No electric motor need be purchased.

- As mentioned above, a smaller prime mover would be needed because its capacity could be more closely matched to the steady-state load to be driven; it could be significantly smaller than would otherwise be required if it were to also start a motor.
- The capacity of the line supplying the motor need not be oversized simply to meet the occasional supply requirements of that motor.
- Consumers are not frustrated with poor quality service caused by voltage variations associated with the operation of the motor.
- It is more efficient. A portion of the energy available is lost in using electricity to drive motorized equipment. If a motor is electricity-driven, the prime mover must generate electricity, losing energy in the conversion from mechanical to electrical power (80 % efficiency). Further energy is lost in transmitting the electricity to the motor, although this should not be significant if the mini-grid has been properly sized (possibly at an additional cost). And finally more energy is lost in the motor as it reconverts the electrical energy back to mechanical energy (at an efficiency of perhaps 80 % for small motors being considered). Therefore, the overall efficiency of this conversion would be about  $(0.80) \times (0.80)$  or 60 - 70 %. In other words, more than 30 % of the energy available from the prime mover would be lost if, rather than directly driving the equipment, electricity is first generated to then drive a motor that in turn powers the equipment. Still additional losses would be incurred if the generator were belt-driven by the prime mover rather than being directly coupled. These energy losses represent increased fuel consumption and, therefore, increased running costs.

The principal advantage of using electricity for motor loads is that it is not always possible to locate these loads close enough to the prime mover for direct drive. This may be because they cannot be located on the same property (possibly because they have different owners); because the powerplant, such as a hydropower plant, is not located in a convenient location for the end-users; or because more than one large, motor-driven end-use is required at different locations in the village. Electricity may be more convenient but unless the capacity of the power supply is sufficiently large and can accommodate electric motors of adequate capacity to operate all the end-uses, another means will have to be found of driving them.

### ***Heat-generating appliances***

Another category of end-uses are those which rely on electricity to generate heat. These include such appliances and equipment as irons, hot plates, cookers, soldering irons, hair dryers, and space heaters. The unique feature of these end-uses is that they consume considerable power and therefore have a major impact on the design of a mini-grid. In a village setting, while individual fluorescent lamps might typically consume up to 20 W, incandescent bulbs up to 100 W, and small motors for power tools up to several hundred watts, heat-generating appliances can each easily consume 1,000 W.

If the capacity of the power supply for a mini-grid is small, as it usually is, the use of these appliances should not be allowed, especially during times of peak village demand, i.e., in the early evening hours. Small mini-grids simply do not have the required capacity to permit the widespread use of these appliances.

If cooking needs were to be met, a more costly power supply and mini-grid would be required. Typically, the peak coincident demand for electricity in many villages in developing countries around the world which have been grid-connected for a number of years is about 250 W. To accommodate the use of a

1 kW hotplate by each consumer without increasing the voltage drop, the generator capacity and the area of the conductor (and its cost) for both the distribution system and the service drops may have to be increased by up to 400 %. Since the cost of the conductor represents a major component of the cost for a mini-grid project, such an increase in the investment could significantly decrease the attractiveness of a project, even if adequate power were available.

The argument is commonly heard that the availability of electricity for cooking would displace fuelwood extracted from forests and reduce the rate of deforestation. While an appealing argument for including this end-use, this is rarely if ever the case unless the cost of electricity is heavily subsidized. One reason for the high cost of electricity is the increased capital cost of the project due to the increased size of the conductor and associated components required, as was just explained. This cost must eventually be borne by the consumer. Another reason is simply the recurring cost of electricity. While energy needs for cooking depends on numerous factors, it can easily amount to several kilowatt-hours daily per household and cost \$10 to \$20 or more each month. For many rural households, this could add considerably to the financial burden they would have to shoulder.

Use of electricity is occasionally promoted as a source of heat energy when the supply comes from a micro-hydropower plant. In this case, the marginal cost of energy (the extra cost incurred by generating more energy each day) is minimal because the fuel is free. This is not the case with a diesel-supplied mini-grid where each 2 to 3 kWh generated requires the consumption of another liter of diesel fuel. But even in the case of a mini-hydropower plant, the capacity limit is still a problem. Consequently, while this approach has been promoted in micro-hydropower projects in Nepal, several types of locally manufactured cookers that reduce each family's power demand have also been developed and promoted (Figs. 14). Each of these designs places a maximum demand of about 250 W on the system. Some designs slowly cook with this low power input (i.e., similar to the operation of a rice cooker) while others use various approaches to store the heat they generate when excess power is available during the day and then extract the heat during the much shorter cooking times.<sup>5</sup>

Another circumstance under which a micro-hydropower plant is used to generate heat is when this is used as a method for governing or controlling the speed of the turbine/generator unit. To generate at a constant 50 or 60 Hz, a constant load must be imposed on the turbine/generator unit. To achieve this, any excess power not used by the consumers is diverted into a water heater to heat water that in turn can be used for productive purposes (clothes washing facilities, hot water supply for cooking, etc.).

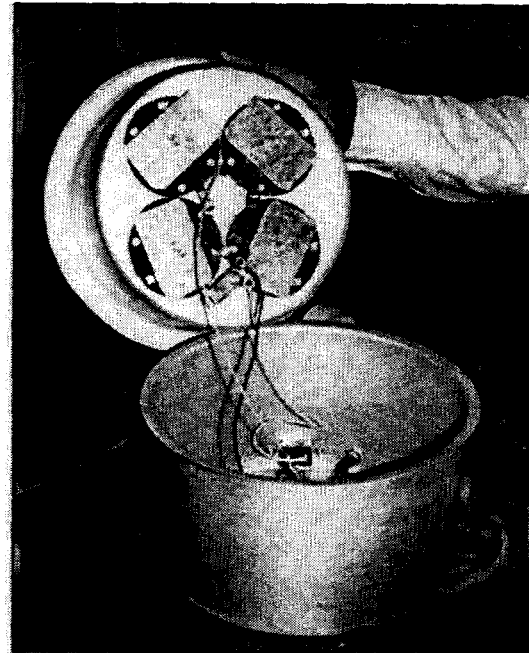
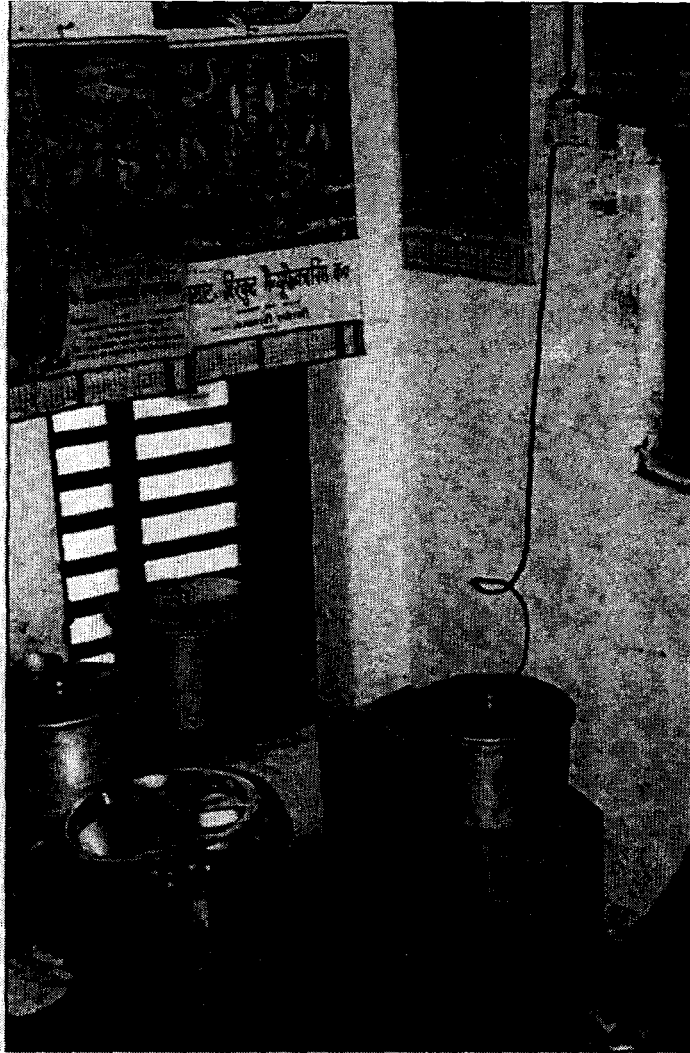
Heat energy is generated by passing electricity through a resistive element. Consequently, voltage variations do not affect the operation of these appliances. The major impact is on the heat generated that varies as the square of the applied voltage. A 10 % increase (or decrease) in the voltage will result in roughly a 20 % increase (or decrease) in heat output. Frequency has no impact on this end use.

## **Demand assessment**

A critical step in the initial planning process is to estimate the maximum initial coincident load\* that the prospective consumers are to impose on the system and how this load is expected to grow over time. This is necessary in order to size both the generating plant (or transformer) and the conductor used in the

---

\* The coincident load is the sum of the loads actually on at any instant of time. This is generally different from the sum of all the individual community loads (called "connected load") because all these loads are not generally on at the same time, i.e., they do not coincide. For example, if two 1-kW motors may be used at the same time for some daytime hours and sixty 50-W bulbs are all lighted during the early evening hours, the connected load is 5 kW but the maximum coincident load that the powerplant must supply is 3 kW.



**Fig. 14. At the left, a locally manufactured low-wattage cooker in use in a restaurant in Nepal. Above are visible the two sections of the cooker just before their lips are welded together. Four heating elements are installed beneath the inner pot. The socket and pilot light are near the bottom of the outer pot. (Photo credit, below: Lionel Mackay)**

distribution system (Chapter VII). Investments in each of these components are significant, and improperly sizing either of these would make it more difficult to cover the capital and/or recurring costs of the system and therefore to ensure system viability:

- Too small a capacity could lead to consumer dissatisfaction with the service, leading to frustration on the part of the consumers and their possible hesitancy to pay the electricity bill. It could also interfere with serving additional consumers or additional load growth which would otherwise increase the consumer base and thereby reduce cost.
- Too large a capacity would mean additional investment costs for the construction and possibly the operation of the system that could be difficult to recoup without raising the tariff to a point beyond the consumers' ability to pay.

Making load projections that reflect reality is frequently a difficult task to accomplish, especially for perspective consumers who have little experience with electrification. Simply asking households what uses they would make of electricity in the home and how many 40-W bulbs they would like to use will not lead to reliable conclusions. Prospective users generally have little knowledge of, for example, the amount of illumination would come from a 40-W bulb in a dark room, what the difference is between the

light emitted from a 40-W incandescent bulb and a 40-W fluorescent lamp, or what monthly costs they would actually incur for each.

Another factor affecting the demand of potential consumers is the unit cost of electricity (\$/kWh). Project implementers should have done sufficient planning to at least have estimated this cost on the basis of approximate costs that the project will incur. (For an idea of the range of costs that might be incurred, see p. 13.) If a tariff to cover all outstanding and ongoing costs is to be set, the project implementer should go through the exercise explained in the Chapter XIV and illustrated in Boxes 15 and 16 (p. 184 and 190). This should provide a more realistic costing of electricity service and give potential consumers a better feel for how much they would have to pay for a certain level of service and whether this will be affordable. Of course, it will also be necessary to gauge the ability of prospective consumers to purchase the required appliances and make use of the electricity.

An indication of the power demand that would satisfy rural consumers might be obtained from a knowledge of how rural households make use of their disposable income and what end-uses are presently found in a typical home, end-uses that could realistically be supplied by grid power.

Probably a more reliable approach for assessing future demand than simply asking potential consumers would be to survey households in adjoining, already-electrified areas or in a region with similar economic activities, disposable income, demographics characteristics, etc. This would determine the average initial loads per household in these areas as well as their historical load growth.

The already-electrified regions that would be surveyed should preferably have a similar type of service as that being proposed in the new community, such as 24-hour power or electricity for 4 hours each evening. Furthermore, it should also be clear that the demand served by these electricity supplies has not been suppressed because of limited generation capacity during hours of operation. Projections of loads in areas to be electrified made on the basis of loads in regions with suppressed demand would understate the actual demand to be met in the new areas. Consumers in the already electrified regions used as the basis for demand projections should also be paying a similar tariff as the one projected in the new areas to be electrified.

Any projections of load and load growth in an area to be electrified using information gathered from already-electrified regions should also consider such factors as the difference in the level of disposable income in the two areas, the presence of raw materials or industry, the potential for tourism, and access to outside markets for goods which might be grown or produced locally. In surveying already-electrified communities, it is also important to determine to what extent three-phase service is required to serve typical loads, such as motors for agro-processing.

The load projection must not simply be that expected the day electricity is switched on. Rather, it must be sufficiently high to provide adequate capacity into the future. How far into the future depends on the specific situation and the size of the required mini-grid investment. For example:

- If a low-cost grid is envisioned simply for lighting in a community where there is little opportunity of increasing disposable income, the load might not be expected to increase significantly. In this case the demand when the project begins may be expected to remain largely unchanged over the life of the mini-grid.
- If a village is located in a fertile region, with road access but with no hope of receiving power from the extension of the national grid, the load projected at the end of the expected life of the distribution system should be used.

- If a village is interested in building an isolated mini-grid to be used only until it is replaced after some period of time by a more conventional distribution system to be installed by the national utility, the load expected over this period of time should be used.
- If a village is interested in building an isolated mini-grid in anticipation of eventually connecting to the approaching national grid, and if they feel that having a mini-grid that can be directly interconnected to the grid once it has arrived, at no additional cost to the utility, provides added incentive for the utility to connect them, a 20- or 30-year planning horizon as is used by the electric utility might be used.

## **Demand-side management**

After projecting the peak coincident demand that is expected at a new project site, it may still be possible to reduce project cost by either reducing the generation or distribution capacity required to meet this peak demand or permitting increased consumer load with the same generating and distribution capacity. This is achieved through demand-side management, i.e., managing electrical demand on the system in order to achieve more efficient use of the investment. For example, original plans might call for a 2 kW grain mill to work during the early evening hours when domestic needs require 8 kW. This would require a genset with a capacity of at least 10 kW. Demand-side management would attempt to restrict milling to hours where it does not coincide with lighting, thereby reducing the required maximum generating capacity to only 8 kW. Box 3 presents other examples of demand-side management.



### **Box 3. Demand-side management in Nepal.**

In the villages around Aserdi in central Nepal, an isolated system supplied by a 1.0 kV line and small transformers serves three types of loads: residential lighting mostly in the evening, hulling of rice and milling of grain generally during the day, and water pumping located at the end of the distribution system. If the pump were to adversely affect the quality of electricity (causing brownouts) by imposing too much demand through the existing distribution line, the demand could be managed by operating the pump during late evening hours when excess line capacity is available. Furthermore, the water system would not be adversely affected by this scheduling because water is stored in a reservoir supplying a gravity-fed water-distribution system.

Another effort at demand management was to implement a capacity-based tariff for the small domestic consumers in the area.\* This is less costly to administer, because no meter, meter reading, or billing is required. But another reason was to encourage off-peak uses of electricity—encouraging 25-W and 50-W consumers to run radios during the daytime to save on battery purchases or encouraging 250-W consumers to use off-peak electricity to assist in cooking.

This latter approach to demand management requires that appropriate electrical end-use equipment be readily available. For example, to encourage the displacement of increasingly difficult-to-find fuelwood with electricity without the peaks usually associated with electric cooking, various designs for low-wattage heat storage cookers have been developed and were promoted. These were designed to be plugged in most of the day when excess capacity is available in the home, storing heat that can later be used for cooking or heating when needed. In the Aserdi region, the 250-W limit was specifically set with this use in mind; it permitted the simultaneous use of the cooker and one light.

---

\* With a capacity- or demand-based tariff, the consumer pays for using up to a pre-selected level of power (e.g., 25, 50, or 250 watts) but can use this power for whatever period of time. Rather than paying a tariff based on the actual energy (kWh) consumed that is measured by an energy meter that periodically must be read and billed by the utility, the consumer pays a fixed monthly tariff. To ensure that the household consumption does not exceed its pre-selected level of power, any of several forms of current limiter is used to restrict demand.



## V. Mapping and system layout

---

After it has been established that potential consumers appear willing and able to cover the costs that will be incurred according to an agreed-upon tariff schedule, that an acceptable electricity supply is available, and that a well-founded and sustainable organizational mechanism exists to undertake such a project, planning can proceed. This chapter will begin by briefly reviewing steps required in preparing a map of the area to be electrified, a map that will assist with the planning and design process and provide a framework within which to collect the necessary data. This chapter will then review factors affecting the placement of the powerhouse and the physical layout of the mini-grid on the map that has been prepared.

### Mapping

The mapping effort should begin with a sketch of the community, starting with the general features found in the village and ending with the placement of specific homes, shops, schools, and other potential village loads.

The map can begin with a sketch that includes the placement of the larger features, including a rough layout of the roads, trails, paths, and streams going through the community. Other landmarks such as village wells, market areas, meeting halls, schools, paddy land, and large trees can then be added. And finally, individual homes should be included.

It will be useful to draw this map somewhat to scale, because distances later will be used to calculate conductor size, pole locations, etc. Although the use of a long surveying tape (30 to 100 m) should give more accurate results, a good first cut should be achieved by simply pacing distances between all the village landmarks and individuals homes. Modern technology such as global positioning system (GPS) receivers can also be used but this requires that another set of skills be developed. Furthermore, the accuracy over small distance such as are found within a community may be less than can be obtained by simply pacing distances.

If distances are to be paced, all individuals involved in gathering data to prepare the map should first calibrate their standard pace. They should decide what feels like their "standard" pace over the actual type of terrain they will be crossing. They should each walk a fixed number of standard paces (e.g., 20) and measure the distance with a tape. From this, they can each estimate the average length of a single pace (e.g., 0.65 m). By doing this several times in different places, they should also be able to get an idea of the accuracy of their pacing. As the village survey proceeds, it would be a good idea to occasionally use a tape to verify the length of these average paces. From this, they can get a feeling for the variation in this average length from place to place and day to day.

Once paces have been calibrated, measurement should start from a specific landmark. Although the finished map should be the same independent of where pacing begins, it would be preferable to start at the location of the proposed powerhouse (see the following section for guidelines in placing the powerhouse). Then pacing can proceed along what might be the eventual alignment of the distribution system.

Once all measurements have been made on the first sketched map, the map can be redrawn closer to scale. This map should be adequate for design purposes. Alternatively, once a map has been redrawn based on paces and the initial distribution system laid out, another iteration can be made using a surveyor's tape, but distances can be rounded to the nearest meter. Greater accuracy is not necessary.

## System layout

The principal use for the map will be to provide a base on which to lay out the distribution lines for the mini-grid so that detailed design work can be initiated (sizing of the power system, conductor, and poles). For this purpose, the next step will be to visit each potential consumer, to assess what design load is to be used during the system peak (the daily coincident peak demand) for that consumer (p. 43), and to indicate this at the proper location on the map. If a motor or other load with atypical characteristics is to be used by any consumer, this should also be indicated.

In addition to assessing initial consumer load, the growth in this load into the future must be estimated as realistically as possible. Also to be included is the expected growth in demand from new consumers, either from existing villagers who are yet unwilling to commit to being electrified or from new households that have yet to establish themselves. And finally, some thought may already have been given to the establishment of new shops and commercial loads in the near future or new institutional loads like a clinic, school, or government office that are under consideration. The size and location of these new loads must also be considered in planning for a mini-grid if it is expected that this grid will serve them.

Once all the design loads to be served have been estimated, the distribution system can be laid out. This requires finalizing the location of the powerhouse, the placement of the lines, and the pole locations. In large part, these are determined by the layout of the village and the general nature of the loads to be served. Factors affecting this aspect of project design are explained in the following sections.

Once the nature of the power demand and the layout of the distribution system are known, the next steps will be to determine the line configuration (Chapter VI), the conductor type and sizes to adequately supply that demand (Chapter VII), and available pole options and size to ensure adequate line clearance and a safe system (Chapter VIII). While a few comments are made below on the placement of poles, this only serves as initial guidance. Final pole placement can be determined after the steps just mentioned have been completed.

### ***Powerhouse location***

The location of the powerhouse will be affected by several factors, but this task is simplified by the fact that there are usually a very limited number of options. These factors include the following:

- **Voltage drop.** As with much of the design planning for a mini-grid, the location of the powerhouse is determined, to the extent possible, by the need to ensure that voltage drop at the end of each line remains within acceptable limits at minimum cost. To achieve this, the optimum generator location is in the center of the load it is to serve.
- **Location of the energy source to be harnessed.** If the powerplant relies on hydropower, it must be located at the most efficient location for power-generation purposes. A very limited number of options usually exist. Power must be transmitted from that point to the mini-grid. While this will increase the cost of the distribution system somewhat, this is offset by the other advantages implicit in relying on low-cost hydropower-generated electricity. If the power source is wind-based, the powerplant must usually be located on a ridge or other high point to tap the largest wind resource, even though this may also be outside the load center. If the source of energy is diesel, the powerplant could be located in the center of the load. However, even in this case, if the village is on the flank of a hill on one side of a valley, with the main road below, it might be more advantageous to generate power just off the road, where fuel drums can be more easily delivered, even though it may be on the outskirts of the village.

It is often the case that a mini-grid is privately owned, as a small business. In such cases, the location of the powerplant owner's property may determine the powerplant location.

- **Size and nature of the end-use.** Irrespective of who owns the mini-grid, if a large load such as a grain mill is to be supplied, it may be most efficient to place the powerplant near that mill to reduce the costs of the heavier line that would otherwise be required to serve that load.
- **Noise.** Diesel-based electricity generation can be a noisy undertaking. If effective silencing of the exhaust is not possible, this might also force the genset to be located at a more isolated part of the village.

### **Placing the lines**

Once the powerhouse has been located, the distribution line is required to bring the electricity to the vicinity of the consumers. The best layout for the distribution system will be one that meets the criteria for voltage drop while minimizing cost and keeping safety and reliability in mind. In general, the shortest line will minimize cost, because this will reduce the cost of both the conductor and poles. Poles are often the most expensive component of a distribution system, and an important part of the design process is to be economical in their use.

Depending on the layout of the consumers relative to the location of the powerhouse, the best layout may be to extend lines in several directions from the powerhouse. Several factors must be taken into consideration in deciding where these lines are to be placed. The relative importance of each must be decided in each situation. These factors include the following:

- **Location of roads, trails, and paths.** The principal reason for locating lines along such arteries is that most present and future consumers typically build their homes along road or trails and these permit easy access for line construction and maintenance. Should street lighting also be a priority, this is facilitated by locating poles along the principal arteries.

Care should be taken if roads carry vehicular traffic. Sufficient clearance under the conductor is required whenever the possibility exists that vehicles will pass underneath. Road crossing should be avoided or minimized whenever possible. The alternative is to use higher, more robust, and therefore costlier poles on either side of the road at each crossing to provide this greater clearance.

In some countries, crossing property lines also causes problems, as many are not eager to have power poles, especially with guys, in the “middle” of their yards, rice paddy, or coconut plantation. Following well-established paths and trails known to be open to the general public minimizes this problem. At other times, in some communities, there is sufficient *esprit de corps* and interest in electrification for all to join together and accept such inconveniences as one of the costs of electrification.

- **Presence of trees.** When conventional lines are built, trees are often the first casualties. The right-of-way along lines is generally cleared of trees to prevent them from interfering with the operation of the line: to prevent branches from falling and breaking conductors or from shorting the lines. In some areas, trees represent a source of income for the villagers (from the sale of fruit and nuts) who are loath to destroy them for this reason.

On the other hand, depending of the strength, flexibility, amount of foliage, and age of a tree, they are sometimes used as living power poles that have already withstood the test of time. These

“poles” have the advantage of requiring no treatment to prevent decay, especially of the buried portion at and just below the ground line that is the most susceptible. Lines are sometimes draped over branches, while at other times, they are properly fixed to spool insulators mounted on the main trunk.

- **Religious buildings/areas.** Buildings or areas of religious or cultural significance must be identified and a clear understanding of what constraints these impose on line routing should be established.
- **Topography.** Certain areas should be avoided if they will complicate the construction or ongoing upkeep and maintenance of a line. These includes steep slopes, areas susceptible to erosion, swampy areas, and areas prone to flooding.
- **Line length.** Because poles and conductor are the most costly component of a mini-grid project, the alignment of the line should be selected to minimize their number and length, respectively.
- **Minimizing changes in alignment.** Whenever there is a bend in the line, the conductor under tension imposes a lateral force on the pole tending to tip it. Depending on the change in alignment at a pole and the tension of the conductor, this lateral force might have to be counteracted by a guy and anchor.\* This adds to the cost and effort required in installing the mini-grid. They also pose a safety hazard, as they may be difficult to see, especially in the evening, or simply get in the way. For this reason, where conductor tension is sufficiently large, an effort should be made to minimize deviations of adjacent spans for as long a distance as possible, “concentrating” bends at as few points as possible..
- **Loading.** If several lines radiate from the powerhouse, the aim should be to equalize the kW·km loading on each line during peak demand times, to the extent possible. This will permit the use of the same size conductor, reducing its cost through quantity discounts and possibly reducing the selection of connection hardware required. This will also make most efficient use of the lines.

However, with three-phase power, another more critical requirement for the proper operation of the generator is that loads on all three phases be as balanced as possible. This requirement becomes more critical as generator capacity is approached and should receive high priority.

- **Planning horizon.** In laying out and designing a mini-grid, an adequate planning horizon should be used and, to the extent possible, the mini-grid should be designed to permit it to be efficiently used over this period. Both new areas into which the grid might expand or existing customers who might expand their use of electricity should be considered.

The focus of the present effort is to lay out the lines that are part of the distribution system itself and will bring electricity to points relatively close to each consumer. Separate from the distribution line are the service drops that are used to bring the power the remainder of the way from the nearest pole to the consumer. Details for the design of the service drops will be discussed separately in Chapter XII.

Depending on the layout of the village, one question that may need to be answered at this stage is how close the main distribution line must approach each consumer. This answer depends on the peak demand or current required by the consumer(s) served by a service drop, the sizes of the conductor that can be used for the service drop, and the maximum allowable voltage drop. At this point, Fig. 101 (p. 148) can

---

\* When electric utilities build distribution lines, guys are typically used on poles whenever the change in direction of the line exceeds 5°.

be used to derive the maximum distance for any given values for these parameters. If too many homes are off in one direction from the distribution line, then one branch of the distribution line may have to be extended in that direction to bring power closer to those consumers and permit shorter service drops.

Once an initial layout for the distribution line has been established, selecting line configuration (Chapter VI) and the size of the conductor for the distribution system (Chapter VII) can proceed.

### ***Locating poles***

Once the general layout for the distribution line has been prepared, poles must be placed along that line to support the conductors with adequate clearance to ensure a line that does not pose any hazard to people or vehicular traffic passing beneath it. Factors affecting pole location include the following:

- **At bends in the line.** As noted in the discussion of line placement, guying may be needed at each bend in the line. Therefore, to minimize the need for guys and anchors and associated costs, hassles, and safety issues, any significant bends along the line should be concentrated at as few points as possible. Poles must then be located at each of these bends.
- **Location of load clusters.** As is explained later (p. 149), it is recommended that each service drop supplying a consumer takes off from a pole rather than from mid-span. For this reason, at least one pole will have to be located near each cluster of homes within a certain radius of the pole. In this case, the location of home clusters determines pole location.
- **Adequate ground clearance.** In areas where homes are less densely located, the type and size of conductor used, the length of available poles, and the required ground clearance will determine the maximum span that is possible. For this reason, pole locations can only be finalized once these parameters have been established.
- **Pole strength.** Mechanical loading caused by wind on the conductor is transferred to the poles (as is described in Chapter VIII). The poles have to be strong enough to support this load, and the strength of the poles available for the project may limit the maximum spans achievable.





## VI. Line configuration

---

To distribute power around a load center, four basic distribution line configurations are possible: two single-phase configurations and two three-phase configurations. These are illustrated in Fig. 15. All configurations use similar materials and construction techniques. On some occasions, a combination of these configurations can be used to achieve a more cost-effective distribution system design.

For a particular village situation, the attributes of each configurations and a rough sizing and costing of the conductor and poletop hardware for each configuration should be assessed to determine which line configuration is the most cost-effective. The sizing of the conductor for each configuration can be found using Table 8 or Box 5 after an acceptable voltage drop has been established. An example of conductor sizing for a sample line and the impact on line configuration on conductor size are illustrated in Chapter VII and in Appendix 7 (beginning on p. 234).

### Options for line configuration

#### *Single-phase supply*

##### **Single-phase, two-wire**

For this configuration, two conductors from the powerhouse serve the entire community at a voltage that is usually nominally set at 120 or 230 V. To ensure a system that can easily be maintained and for which construction materials and consumer appliances can readily be found locally, this voltage should coincide with the standard in use in the country.

If the powerhouse is located in the middle of the load center, single-phase lines might take off from the powerhouse in several directions. Consumer connections to this system are straightforward: the mini-grid is comprised of a pair of conductors that pass by each consumer and the service drop simply taps both of these lines (Fig. 15a). From this point of view, this is the simplest option to design and is therefore the most commonly used for mini-grids. But it is not the most efficient option. System design for the other options is somewhat less straightforward because the distribution lines include at least three conductors, and the system designer is faced with a choice of which pair of these conductors each consumer should tap so that the loads are balanced. Balancing loads along a distribution means that, as one proceeds along that line, loads are connected to each phase conductor in a such way that the currents in these conductors are as close to equal as possible.

A pair of single-phase lines can also be used with a single-phase, three-wire configuration as well as with both three-phase configurations, when a small load off in some direction does not warrant stringing a split-phase or three-phase line in that direction (Fig. 15b, 15c, and 15d). It should be noted that even under circumstances where three-phase power is generated, three-phase power may not be used or needed by any one consumer. Rather, pairs of single-phase lines leave the three-phase generator in various directions to serve the different portions of the community.

It is possible to ground one of the conductors of a single-phase system (as shown by the dotted ground in Fig. 15a). This is discussed at the end of this chapter.

While mini-grids frequently use this basic configuration because it lends itself to being easily understood, this is the most costly configuration (as is illustrated in Table 4 below). However, two comments about single-phase distribution should be made at this point:

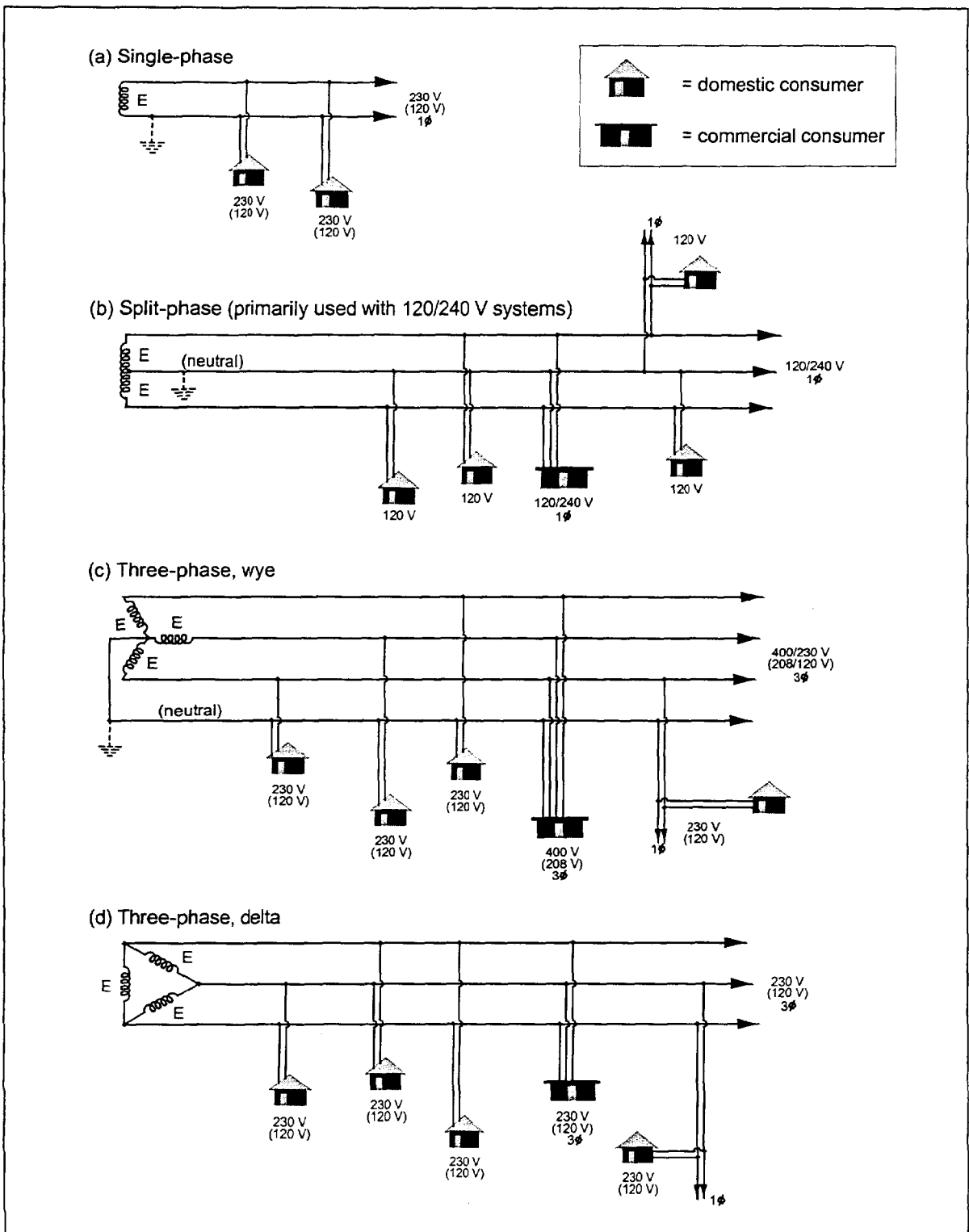


Fig. 15. The four basic distribution line configurations that may have application for a village mini-grid. The supply (on the left) can be either a generator or transformer. *E* represents the commonly used voltage in the country (generally 120 V or 230 V).

- In theory, the three other configurations described in this chapter are all cheaper for serving a specific load than the basic single-phase, two-wire configuration in terms of conductor cost. However, for lightly loaded lines, minimum conductor size is set by mechanical constraints, i.e., the need for strength in tension. Therefore, the capacity of the smallest acceptable conductor selected on the basis of strength may, when used in a simple, single-phase two-wire configuration, still be more than adequate to serve the load, within acceptable voltage drop limits. In this case, reverting to the use of a more efficient, split-phase or three-phase configuration would unnecessarily increase cost, because the added value of the increased current-carrying capacity associated with the other configurations would not be needed. The precise point where split- or three-phase configurations are more economic is site-specific; it depends on the size and locations of the loads along the line and the size of the smallest usable conductor.
- In those countries where the nominal consumer voltage is 120 V, this configuration has another advantage. If a three-phase line serves a community which, after some time, begins to place excessive demand on the line (based on voltage-drop criteria), the line would have to be reconducted. This means that the existing conductor would have to be removed and replaced with a larger one, incurring increased material and labor costs. However, if a single-phase, two-wire, 120 V configuration supplied by a single-phase generator had been used, it would have been possible to capitalize on the higher initial investment by simply adding a single conductor. If the loads were perfectly balanced along the line, adding this conductor would increase line capacity by four. Even if there were a 50 % load unbalance, adding this single conductor would still more than double line capacity. (The meaning of the load unbalance is discussed in the following section).

The following interventions to a single-phase, two-wire line would have to be made to transform it into the more efficient split-phase three-wire configuration discussed in the following section:

- Add a third conductor to the existing line.
- Reconnect the powerplant so that its full output voltage is split, e.g., 120-0-120 V rather than 120 V.
- Move the existing service drop connections to the new conductor as necessary to ensure balanced loading on both phase conductors.

If this configuration seems advantageous, the adequacy of line-to-ground clearance after adding the third conductor must be verified.

### **Single-phase, three-wire (split-phase)**

This single-phase configuration, which requires the use of three rather than two conductors, is primarily used with systems operated at a nominal consumer voltage of 120 V (Fig. 15b).<sup>\*</sup> In this case, the

---

<sup>\*</sup> Three-phase distribution is generally more efficient than single-phase distribution and is commonly used around the world. In North America, a significant portion of Latin America, and a few other countries influenced by the U.S. (such as the Philippines, Japan, and Liberia) where consumers use electricity at 120 V, three-phase power is available primarily in the more heavily populated areas. When faced with the task of serving sparsely populated rural areas in the U.S. in the first half of the twentieth century, engineers decided that single-phase distribution at the medium-voltage level was fully adequate and less expensive. But at the low-voltage level, distributing single-phase power to individual consumers at 120 V is not efficient. The alternative that was developed was to rely on a single-phase, three-wire system (120-0-120 V), which permitted the distribution of single-phase power almost as efficiently as three-phase power (Table 4). On the other hand, in Europe and in parts of the world influenced by European countries, systems supplying the consumer with 230 V have traditionally been three-phase everywhere, in both rural

generator is connected to generate twice the nominal voltage (at 240 V rather than at 120 V). The two phase-conductors are connected at the ends of the generator winding. The neutral conductor, which may be grounded as is explained at the end of this chapter, is connected to the center-tap of that winding. This configuration is also referred to as a split-phase or, in some countries, a dual-phase configuration.

In countries where the nominal consumer voltage is 230 V, a single-phase, two-wire system that has outgrown its capacity can also be converted to the more advantageous single-phase, three-wire system. However, because generators to generate 230-0-230 V are not commonly available, converting to a three-wire system to make use of its increased capacity would require connecting the 230 V generator output to a 230/460 V transformer, with a center-tapped secondary. This secondary would be connected to the three-wire line as described in the previous paragraph.

As is shown in Fig. 15b, one of the two conductors serving each of the typical residential consumers always taps the neutral conductor of the distribution line. The other always taps one of the two phase-conductors. In selecting which phase conductor to tap, it is important—both to minimize voltage drop as well as to ensure proper operation of the generator—that the maximum coincident loading on each of the two phase-conductors be balanced.

If the consumer loads located off in some direction are too small to justify stringing all three conductors, a single-phase, two-wire line can be drawn to serve those loads. As before, the phase-conductor to be tapped by the line extending in that direction should be selected with the objective always in mind of balancing the loads on the main (three-wire) line(s).

The split-phase configuration provides a couple of advantages over the previous configuration:

- **Reduced cost:** This configuration can result in savings in the cost of the conductor because a smaller conductor can serve the same load. Alternatively, with the same size conductor, either a greater load can be served or the same load can be served with a smaller voltage drop and line loss.

If loads are properly balanced along the line, the neutral conductor would carry much less current than the phase conductors (zero current if the line were perfectly balanced) and negligible voltage drop would appear along the return or neutral line. This approach is more effective because each of the smaller single-phase loads is therefore only affected by the voltage drop along one conductor instead of two. Also, by operating a balanced line at twice the voltage, half the current is required to serve the same total load. The percentage voltage drop and the power loss are therefore both reduced to a quarter of those in the single-phase, two-wire configuration described above for the same size conductor. Alternatively, with a properly balanced load, this configuration can use a conductor with one quarter the area (i.e., four times the resistance) and still have the same voltage drop and power loss as in the first case. While it does require three lengths of conductor rather than two, these conductors are smaller and less costly.

Table 4 indicates the relative cost for the four possible configurations discussed in this chapter. A cost of 4.0 has been assigned as the cost for the single-phase, two-wire system. In preparing this table, the following are assumed:

---

and urban areas. Therefore, under these circumstances, adopting a single-phase, three-wire variant (230-0-230 V) would have no advantage over three-phase power that was already commonly available. As a result, 230-V single-phase generators are typically available only with a maximum output of 230 V, while 120-V generators can be connected to have a maximum output of 240 V in a 120-0-120 V configuration.

**Table 4. Relative conductor costs for distribution systems serving both balanced and unbalanced loads with the same percentage voltage drop. Note that the cost of labor and poletop hardware, which can be significant, has not been included in this comparison.**

Line configuration	Relative conductor cost	
	Balanced loads	50 % unbalance
Single-phase, two-wire	4.0	4.0
Single-phase, three-wire	1.5	2.0
Three-phase, four wire	1.3	2.0
Three-phase, three-wire	3.0	3.2

Note assumptions in accompanying text.

- The conductor size for each configuration in the table is selected to result in the same line performance for all cases, i.e., the same percent voltage drop along the line while serving the same size load.
- The neutral conductor (in those cases where there is one, see Fig. 15bc) has the same size as the phase conductors, as is often the case (even in the case where, with a properly balanced system, the neutral would handle a much smaller current and the conductor could be correspondingly smaller).
- Conductor cost is proportional to its cross-sectional area, which is approximately the case.
- Conductors are available in a continuous range of sizes. In reality, conductors come in a few discrete sizes.

If loads are properly balanced, the relative cost for the two single-phase configurations described above can be seen in the first two rows in Table 4. The split-phase configuration requires one-quarter the conductor size (and cost) of the single-phase, two-wire configuration but 50 % must be added to that because three rather than two conductors are now required (assuming conductors of equivalent size).

If loads are not perfectly balanced, which is typically the case, cost savings still exist but are somewhat reduced, depending on the degree of unbalance. Table 4 also indicates the relative cost for circuits designed to serve an assumed unbalanced load of 50 % with the same voltage drop.\*

While the cost of the conductor associated with the split-phase configuration would be reduced, this saving might be slightly offset by the increased cost of the poletop hardware associated with

\* Given the situation with a single-phase (three-wire) or a three-phase system where one load is less than the other one or other two equal loads, respectively. The percentage unbalance of these loads served by these lines is defined as 100 times the different in the magnitude of these two different size loadings divided by the average of all two (or three) loads. For example, for a single-phase (three-wire) system with loads of 3 kW and 5 kW, the unbalance is 50 % (a difference of 2 kW divided by an average load of 4 kW). Similarly, for a three-phase system where the loads are 7 kW, 7 kW, and 4 kW, the unbalance is again 50 % (a difference of 3 kW divided by an average load of 6 kW).

stringing the third conductor. However, if aerial bundled cable (ABC) or multiplex were used for the distribution line, the poletop hardware would remain unchanged (see Box 4, p. 65).

It should also be noted that, while three-phase, four-wire distribution is the most efficient means of transmitting power, the difference in cost between this configuration and the simpler split-phase configuration, when only conductor costs are considered, is small. The inclusion of labor and poletop hardware costs can change the relative costing.

A case study in Appendix 7 calculates the cost of using a variety of configurations to serve a given load. It also illustrates that, while considerably smaller and less costly conductor might be possible with some configurations as noted above, increased labor and poletop hardware costs may be incurred. (p. 234).

- **Increased efficiency for running larger motors (this advantage is generally restricted to systems which are nominally 120 V):** If a larger motor load is to be run in the village, it can be served more efficiently by tapping the two phase-conductors to take advantage of the higher voltage of 240 V.

### ***Three-phase supply***

In addition to being able to provide single-phase service (e.g., at 120 or 230 V) as with the two previous options, this supply option also provides three-phase service (i.e., 208/120 V wye or 120 V delta and 400/230 V wye or 230 V delta, respectively) for consumers who need larger quantities of power to run larger motors or other industrial processes. However, while three-phase power has some advantages over single-phase power, the reality is that even in areas where three-phase power is distributed, use is typically only made of “simpler” single-phase power, which adequately supplies all appliances and end-uses commonly found in a rural home.

However, the layout of the community, the location of the powerhouse in relation to the village center, and/or the need for three-phase power along the main road for commercial purposes in the vicinity of the powerhouse may suggest that an initial length of line from the powerhouse use a three-phase configuration. It would then divide into individual single-phase lines to supply the remainder of the village. If this is the case, when tapping the three-phase line, loads on each of the three phase-conductors should be as balanced as possible to minimize voltage drop and ensure proper operation of the generator.

Several disadvantages are associated with three-phase, and even split-phase, distribution over the single-phase, two-wire configuration:

- Using three or four conductors rather than two means that a higher pole may be required to maintain the same ground clearance, and more poletop hardware would be required (unless some form of bundled insulated cable is used).
- Making most efficient use of these two options requires that some additional care be taken to balance peak-time loads on the different phase conductors.
- If the load served by a mini-grid expands to exceed its design value, the only way of increasing its capacity is by reconductoring, i.e., replacing all the conductors with ones of larger size, a costly and time-consuming undertaking.
- For systems with low electricity demand, mechanical strength determines the minimum size of the conductor. Consequently, it is possible that the excess capacity available from the three phase

configuration with this smallest usable conductor is not necessary and that a single-phase line would suffice.

Three-phase generators can be connected in two different configurations, either as four-wire delta or as three-wire wye (or star). One point in common with both configurations is that generator manufacturers generally require the user to derate the generator in cases where the outputs are not balanced. If this is not done, load unbalance can result in excessive generator heating and eventual failure of the unit. This may well have been one of the contributing factors to the generator burning out in the case of the mini-grid in Laos, presented in the Appendix 2 (p. 198).

### Three-phase, four-wire (wye)

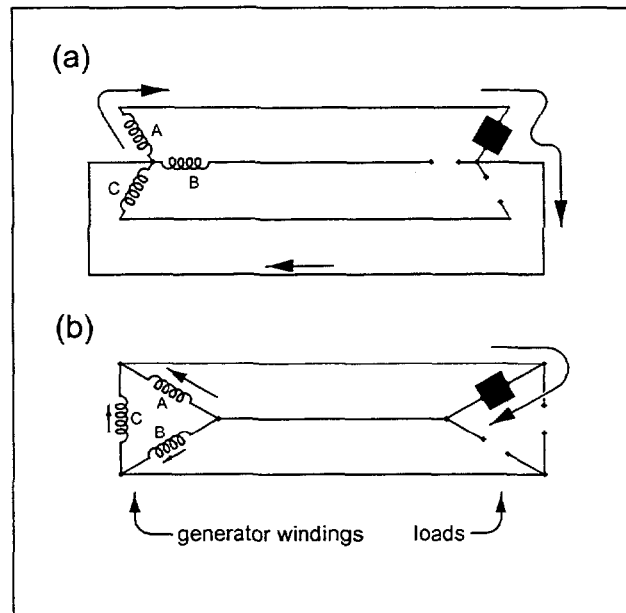
This is the configuration commonly used for low-voltage three-phase distribution networks designed by national electric utilities and can be the least expensive. As illustrated in Fig. 15c, this configuration can supply both single-phase consumers as well as larger end-uses requiring three-phase power. As noted in Table 4, this configuration is generally more efficient than the infrequently used three-phase, three-wire (delta) alternative. The increased efficiency of the wye configuration arises because current is transmitted at about 1.7 times the voltage associated with the delta configuration. This means less current is required, which reduces percentage voltage drop and power losses in the distribution line by factor of three for a balanced system.

The neutral conductor may be grounded but this is not essential, especially in the case of mini-grids, as will be discussed below.

### Three-phase, three-wire (delta)

This configuration is less frequently used for electricity distribution. While Table 4 indicates that this is a costlier option than the three-phase wye configuration, it also indicates that unbalanced loading on a delta-connected distribution system has a smaller impact on voltage drop with this configuration than with the split-phase or three-phase, four-wire configuration. This is explained in the following paragraphs.

For the sake of simplicity assume that only one phase is loaded (Fig. 16). In the case of a wye configuration (a), the entire current is supplied by a single generator winding (A). The windings supplying the other two phase conductors (B and C) supply nothing to this load because those circuits are open. Consequently, if a 6 kW generator is used, the maximum load that could be served without exceeding the rating of the generator under these circumstances would be 2 kW. In the case of the delta configuration (b), winding A supplies two-thirds of the necessary current, with the remaining two windings each



**Fig. 16. While the wye-connected load is only supplied by one winding, all three windings contribute to supplying each delta-connected load.**

supplying one-third of the required current.\* Consequently, the maximum load that can be imposed on any one of the three output circuits of a delta-connected generator can exceed the maximum load associated with the wye system by 50 % before reaching the maximum current rating of one of the three generator windings. Therefore, for example, the 6 kW generator connected in a delta configuration could now serve a maximum single load of 3 kW. However, if one of the output circuits is overloaded, the other outputs must accordingly be loaded below capacity.

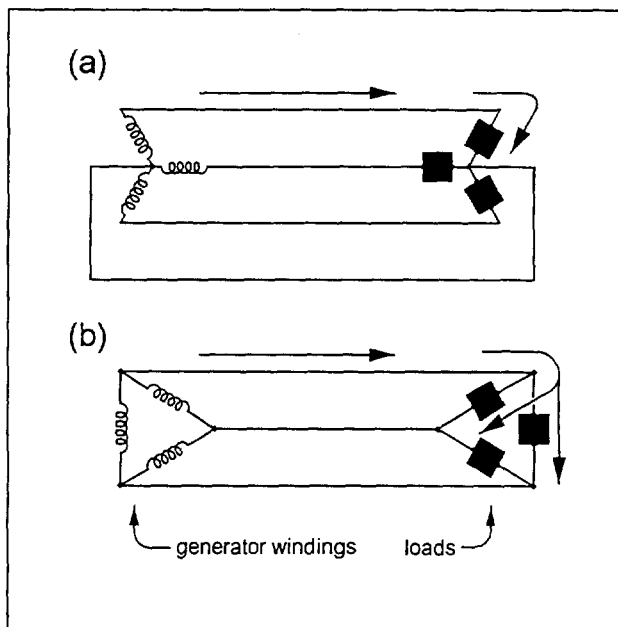
In actual operation, loads would be placed on all phase conductors, but each phase conductor would share in serving two loads in the case of a delta configuration (Fig. 17b) rather than in only serving one (Fig. 17a). Alternatively, this can be seen as each winding sharing in the supply of each load. It is therefore possible for one or two loads to each exceed the rating of one winding as long as the remaining loads are less.

In summary, while the delta configuration is not the cheapest option in terms of conductor cost for the line it supplies, it does have the advantage that unbalanced kW loading increases voltage drop by a smaller amount. Furthermore, because loading is shared by the generator coils, a delta-connected generator can accept about twice the load imbalance than can a wye-connected generator. These facts can prove to be advantageous in cases where balancing the kW loading on the various circuits leaving the powerhouse cannot be achieved because of the layout of the village loads.

## System grounding

One more issue to consider at this point is whether or not to ground the neutral conductor for those three configurations marked with dashed grounding symbols in Fig. 15. At medium voltages, system grounding is typically used to protect the electrical system and ensure safe and reliable service. With one conductor firmly bonded to the ground, it permits economies in the construction and use of various line equipment—such as transformers and insulators—by permitting a reduction in the required insulation levels. It increases the effectiveness of lightning arresters by providing a low-resistance path to ground and also somewhat reduces voltage drop along a line by allowing some of the return currents to flow through the earth. It increases worker and public safety, in part by facilitating the detection and subsequent isolation of any fault to ground that might occur. An example of a fault to ground would be one caused by a phase conductor breaking and falling down to earth. The system ground(s) would provide a return path for the fault current, completing the circuit. If ground resistance is sufficiently low,

\* These seem to add to more than the required current. This is not the case because the windings do not supply all the currents at the same time (i.e., the currents are out of phase).



**Fig. 17. Each phase conductor supplies one wye-connected load while each delta-connected phase supplies two.**



current through the ground loop would trip a breaker. Multi-grounded neutrals attempt to minimize ground resistance and thereby maximize fault currents by providing multiple low-resistance return paths.

However, detecting a fault current even on a medium-voltage system may still be difficult because of the relatively high resistance commonly found between the conductor that has fallen on the ground and the ground itself, even though a fallen conductor can still prove lethal to the touch. It is even more difficult on a secondary system because, from Ohm's law, the considerably lower voltage implies a considerably lower fault current. Two additional factors reduce the effectiveness of grounding for small systems commonly associated with mini-grids:

- The fault current that can be supplied by a small generator is limited.
- Those installing mini-grids often do not put in the effort required to ensure reliable low-resistance grounds.

For these reasons, fault currents associated with low-voltage mini-grids can be too small to trigger miniature circuit breakers (MCBs) or blow fuses. Therefore, the neutral conductor should not automatically be grounded in the hope that this affords added protection. Grounded mini-grids may actually prove more dangerous. For example, when a person touches an appliance with an internal short to its metal housing, a ground provides a direct path for any fault current through the body to return to the generator. This current may be too small to trigger an MCB or blow a fuse but can be more than sufficient to place the person at risk. This is discussed in detail in Chapter XI on safety.

Generally, little justification can be found to ground the neutral conductor of an isolated low-voltage mini-grid. More detailed descriptions of grounding and safety are found in Chapter XI. In the case of a mini-grid supplied by a transformer connected to a regional or national grid, the approach to grounding will probably be determined by the national standards in force in the country. And in these cases, the neutral conductor may well be grounded.

The following approaches are suggested for an isolated mini-grid:

- For low-cost, unsophisticated systems, with primarily lighting and entertainment loads that present the user with little chance for touching an energized portion of the circuit, a floating (i.e., ungrounded) system can simply be used. This is safer and less costly than grounding both the system neutral and consumer grounds and bonding the latter to the neutral conductor. And a system ground, even with a properly installed consumer ground, will not give a person accidentally touching the live conductor any protection. Under this latter condition, a floating system at least reduces the magnitude of the current that might flow through someone touching a live component.
- For the occasional consumer who is using other equipment with a metal housing or frame, fault currents through the body can be reduced through the use of a consumer ground. Or for an additional financial outlay, a properly installed and operating RCD will immediately open the consumer circuit when it senses a fault current. But in these cases, the system neutral should nowhere be grounded.

Depending on whether or not the system is grounded, the following actions must be taken:

- *If the system (i.e., the neutral conductor used in the system) is not grounded*, then all conductors should be treated as live phase conductors. While a neutral conductor might be no more than a few volts above ground, an accidental grounding of any of the phase conductors would raise the voltage of the neutral conductor to the system voltage. Therefore for a floating system, all

conductors should be treated as phase conductors and be adequately insulated. In addition, multi-pole MCBs, which automatically open all conductors when a fault occurs on any one phase, should be used. Fuses might also be used. In this case, these must be used in conjunction with a multi-pole (e.g., a knife) switch mounted on the supply side of the fuse to permit the consumer's circuit, including the fuse, to be isolated manually. This removes the threat from any voltage that might otherwise be present on the line(s) with any fuse still intact and permits the household circuit to be repaired and fuse replaced without fear of shock.

- *If a grounded system neutral is used*, then multiple grounds should be used along the system. It is also important that all metal surfaces associated with the generating and electrical system in the powerhouse also be bonded to the system ground. Consumers who utilize equipment or appliances with metal housings should also ground equipment on their premises by bonding it to the grounded neutral conductor on the supply side of the distribution board. Placing a ground rod at the consumer's service entrance would provide an additional margin of safety.

## VII. Conductor

---

Once the nature of the loading has been determined, the selection of a conductor to most effectively serve consumer load and load growth at minimum cost can be assured by following the standard approach for properly sizing the conductor. In this process, both the voltage drop at the end of the line as well as energy (kWh) losses along the line—both of which depend on conductor size—must be kept within acceptable bounds. This chapter will first briefly review the types of conductor that might be used for the distribution of electricity around a load center and some of their attributes. It will then describe how conductors are sized and installed.

### Types of conductor

For electricity distribution, two materials are generally used: copper and aluminum.

Copper is available in several forms. Hard-drawn copper is used as a conductor because of its higher strength. Annealed copper is used as a ground wire and for other applications where it is necessary to bend and shape the conductor. Annealing copper—heating it to a red heat after drawing it through the drawing die—softens it and reduces its strength from about 390 MPa for hard-drawn copper to about 240 MPa. For this reason, it is also not good practice to use soldered splices with hard-drawn copper when its full strength must be utilized. Soldering anneals the wire near the joint, reducing its strength. Splicing sleeves should be used for joining lengths of conductors.

Aluminum is presently widely used but it only has two-thirds the conductivity of copper. Comparing two conductors with the same resistance per unit length, an aluminum conductor requires 1.6 times the area of a copper conductor. Such an aluminum conductor would have 75 % the tensile strength but only 55 % of the weights of the equivalent copper conductor. Aluminum is preferred in many cases because its smaller weight-to-strength ratio permits longer spans and potentially fewer poles. But pure aluminum conductor stretches easily in high winds or if objects fall on it. Therefore, to increase its strength, aluminum strands can be wrapped around a steel core to obtain steel-reinforced, aluminum conductor (ACSR). ACSR is the most widely used conductor for lines constructed by conventional utilities.

Steel conductor has also been used, because its low cost can, under certain circumstances, compensate for its relatively high resistance. An example of using steel conductor for making low-capacity service drops is described in Box 8 (p. 147).

Below are described the basic conductor types that might be used in mini-grids and some of their characteristics:

1. **Bare conductor.** This is one of the most common types of conductor used with conventional low-voltage distribution systems around the world. Commonly, ACSR is used.
  - Because this conductor is bare, it provides an increased safety hazard either to people working on the line or to villagers who may come into contact with a conductor, either by touching a fallen line or by touching an installed line either directly, with a tool or long poles they may be carrying, or by riding in a vehicle that is too high. Maintaining sufficient clearance is essential, as is abiding by strict construction standards; otherwise, bare conductor should not be used.

- ACSR is only commonly available in sizes down to about 13 mm<sup>2</sup> (AWG #6). Smaller uninsulated aluminum or copper conductor can more easily break and present a safety hazard to villagers.
  - Because no insulation is used, these conductors must be individually strung on separate spool insulators. This requires the used of additional hardware and time to install.
2. **Single insulated conductor** (Fig. 18). This type of conductor consists of copper or aluminum over which a layer of plastic insulation, most commonly polyvinyl chloride (PVC), is laid. The conductor may be stranded or solid, with solid conductor predominately in the smaller sizes (under 13 mm<sup>2</sup>.) This type of conductor is manufactured almost everywhere and is commonly used for housewiring.

- The installation of this type of conductor is usually done in areas far from any regulatory body, and installers tend to be untrained. It is therefore difficult to maintain acceptable safety standards.

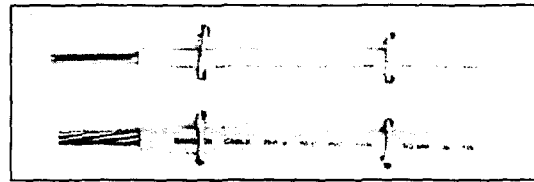


Fig. 18. Single-core, insulated conductors.

- This conductor is convenient in that it can be deadended by simple wrapping.
  - Least expensive as an initial investment and readily available.
  - UV protection may be a problem with certain types of insulation.
3. **Non-metallic-sheathed multi-conductor**. Two or more insulated conductors overlaid with an outer sheath or jacket (Fig. 19).

- Deadending is done by wrapping or knotting since no specific hardware has adapted for exterior deadending.
- Because of availability, ease of installation, and safety, this conductor is commonly used for informal minigrids.
- Because of the weight to strength ratio of this conductor, spans are generally limited to less than about 10 meters.

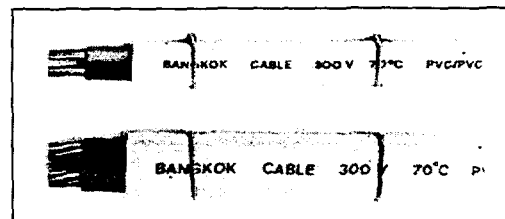


Fig. 19. Non-metallic, sheathed multi-conductors.

- UV protection may be a problem with certain types of insulation.

4. **Multiplex and aerial bundled cable (ABC)**. This cable is composed of one or more insulated stranded conductors, which are commonly aluminum, wrapped around a messenger conductor. The messenger, which serves as a conductor as well as the member which supports the weight of the entire bundle of conductors, can be either insulated or bare. ABC is designed specifically for use with distribution lines, whereas multiplex has been specifically manufactured for use as a conductor for secondary drops. However, as explained in Box 4, multiplex can also be used for distribution lines.

#### Box 4. Use of multiplex for distribution lines

For conventional low-voltage distribution lines, two, three, or four separate bare ACSR conductors are typically used for the distribution line, and duplex, triplex, or quadruplex is used as the conductor for the service drop, for which it is specifically manufactured. This box describes an alternative approach that uses multiplex conductor for the main line, exploiting the advantages of using insulated conductor for this purpose, as is detailed earlier. Multiplex could then also be used as the service drop, although considerably smaller and less expensive conductor would likely be used with mini-grids.

This approach basically involves raising the multiplex and then sagging it span by span. But only the messenger cable is supported at each pole; the other conductors are wrapped around the messenger, which is deadended on a spool insulator at the end of each span or up to once every 5-6 spans.

If deadended at each spool insulator, the multiplex and other conductor form loops (between the two deadends on opposing spans) (Fig. 20). It is from this loop that all household connections for the individual service drops are made (Fig. 21). These connections are most effectively made by removing the insulation at the loop and using ordinary split-bolt or compression connectors. While there are special connectors to tap multiplex line by piercing the insulation, these are more costly than ordinary connectors and may be difficult to procure after the initial line has been strung and additional consumers would like to be connected.

Since the other conductors do not need to be supported at the pole, hardware and labor savings are realized through the elimination of this additional hardware and the time required for their installation. The use of multiplex in this manner is similar to the use of ABC, which, unlike multiplex, has been designed specifically for this application. However, ABC is somewhat more expensive and uses special, more costly connectors. For installation of the multiplex, the same standard hardware (upset bolts, clevises, spool insulators, and brackets) is used as is used with the installation of the more conventional multiple uninsulated conductors. No expensive separators or covered connectors are required.

To take full advantage of long spans where ground clearance permits, ACSR should be used as the messenger conductor.

*(Continued on next page)*

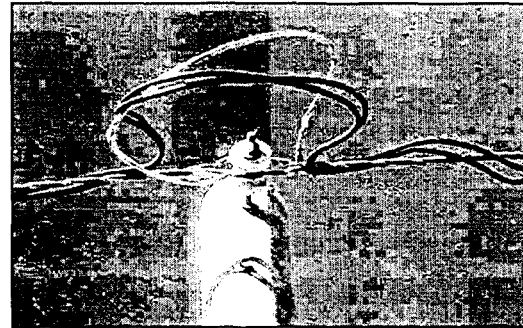


Fig. 20. A loop between two adjacent deadended spans of triplex. (Photo credit: Myk Manon)

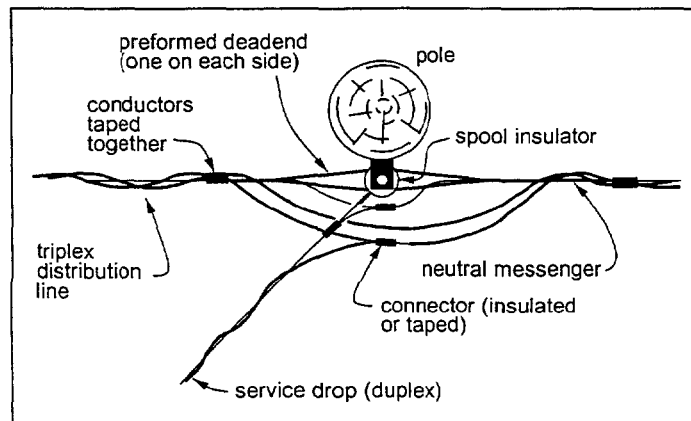


Fig. 21. A duplex service connection to a triplex distribution line, similar to that shown in Fig. 22.

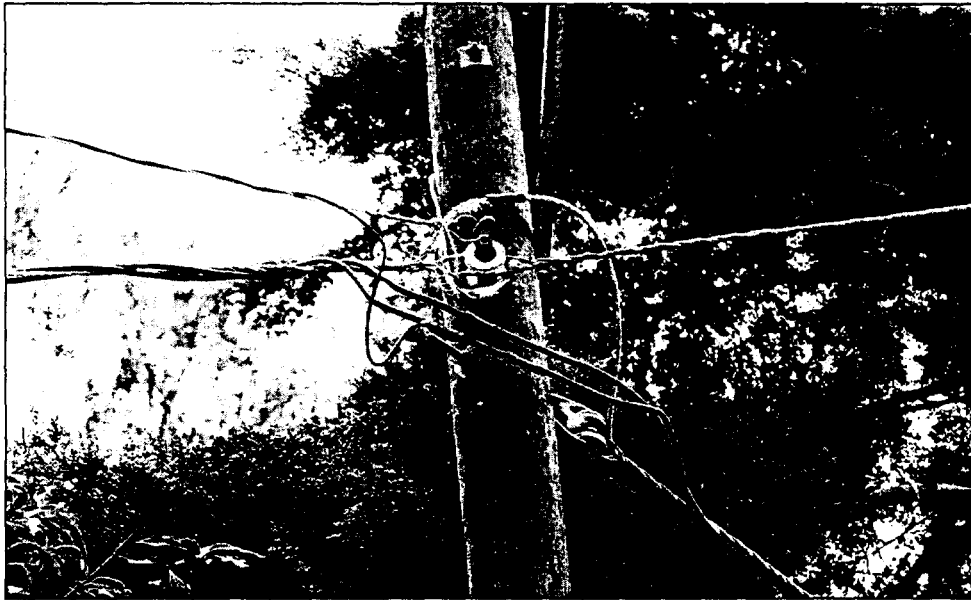
*(Continued from previous page)*

If each span is deadended, an initial concern may be the assumed additional time that would be required to deadend the secondary multiplex conductor at each pole. However, experience has shown that the time to deadend each span over some distance is less than the time to sag a multi-span length of conductor over the same distance, especially if preformed deadends are used. In El Salvador, where this design has been implemented, installing a preformed deadend takes no more than half a minute. Bolted deadends, on the other hand, take several minutes to secure and are about five times as expensive.

### **Installation guidelines**

For installation, the conductor is deadended on a spool insulator at the first pole. The lineman then brings the conductor up to the proper sag from the adjacent downline pole and deadends that span on a spool insulator. (Appendix 8 gives one example of sag tables for duplex and triplex with ACSR messenger. Methods for measuring sag are found beginning with p. 82). He then makes a connection loop on that pole and deadends the beginning of the next span. The lineman proceeds to the next pole to raise the conductor for that span to its proper sag, deadends the other end, makes a loop, and proceeds sequentially down the line. Figure 22 illustrates one poletop connection with a duplex tap to a household.

Along spans that are inclined, the insulated conductor must be served (secured together) to the messenger to prevent the insulated conductor from slipping down along the messenger. This is standard practice with multiplex service drops. This is most effectively accomplished through the use of nylon cable ties, although taping the conductors together with electrical tape is also commonly done.

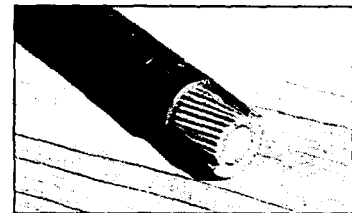


**Fig. 22. A #2 triplex line coming from the center left, is deadended on a spool insulator, and then continues to the lower right. At the loop, a #6 duplex service connection is made and leaves toward the upper left. The neutral conductor at the loop is spliced to the next section. One of the insulated conductors at the loop is also spliced. On the other insulated conductor, a taped compression connection has been made to the insulated duplex service drop. (Photo credit: Myk Manon)**

Multiplex with one, two, or three conductors wrapped around the messenger conductor is called duplex, triplex, and quadruplex, respectively. The messenger is commonly ACSR to provide the necessary strength.

- Maintenance costs associated with these types of cable are reduced because clearing tree branches from the lines need not be as frequent. In addition, the size of the cleared area around the conductors may be reduced, lessening the adverse visual and environmental impact associated with overhead conductors.
- These types of conductors are safer than uninsulated conductor. Branches falling on uninsulated lines present a hazard. This hazard is more to persons coming into contact with the branches when they try to remove them (especially if the system neutral is grounded) than to the system itself. Even though resistance to current flow through the branches is sufficiently high that breakers or fuse protection will often not trip, the system will not be damaged. However, if a person forms a parallel path to earth, sufficient current may pass through that person to present a hazard. Insulated conductors do not pose this hazard.
- The danger to individuals who might come into contact with the lines (caused by individuals carrying sticks or other long objects, children flying kites, or linesmen working on the line) is reduced because of the insulation. Furthermore, when new buildings are constructed, owners rarely consult the electric utility about necessary clearances between the lines and the structure. In these cases, this type of conductor is more forgiving.
- Linemen working on the lines prefer the added insulation. While electrical shocks at 120 or 230 V are not always fatal, they are a nuisance. Furthermore, adequate protective equipment and training is often not given to those working on energized lines.
- A problem common to many countries is the theft of electricity by individuals tapping the secondary conductors, especially in more densely populated areas where narrow streets compel the lines to run close to buildings. With ABC, it is difficult to tap the line without special piercing connectors because of the insulation and the fact that the conductors are bundled. With multiplex conductor used as the main distribution line, taps can only easily be made at the loops at each pole, reducing the length over which the line can be illegally tapped.
- Only a single conductor rather than multiple conductors has to be strung, reducing time and labor costs.
- Because of the greater weight per unit length of the bundled cable, total sag of a single multiplex or ABC will be greater than that for a single conductor. However, except for long spans, the total sag associated with multiplex or ABC will usually be less than the sag associated either the two (for single-phase service) to four (for three-phase service) conductors that would otherwise be used, affixed to the pole in a vertical configuration (i.e., not on cross-arms). The added ground clearance gives the advantage of longer spans on the same size poles and can provide an increased line-to-ground safety margin.
- Stranded conductors are preferred over solid aluminum. Stranded conductor is more flexible to work with when making connections.
- Phase and neutral conductors can be clearly identified.

- Self-supporting cable can be used for spans of up to 150 meters, with significant sag, but it is more commonly used for shorter spans.
  - Unlike copper or aluminum, single-conductor insulated wire that can be found in most hardware stores, aluminum multiplex and ABC must be procured from electric utility suppliers.
  - The need for ultraviolet (UV)-resistant insulation should be made explicit.
  - Electro-chemically, aluminum multiplex is compatible with the aluminum conductor commonly used for conventional distribution systems.
  - Aluminum multiplex is less expensive than copper conductor.
5. **Concentric neutral.** One central conductor, stranded or solid, is insulated and overlaid with a layer of bare neutral stranded wire and jacketed with another layer of insulation (Fig. 23). More commonly used as a service drop.
- This cable provides excellent mechanical protection to the energized conductor because the neutral is woven around the insulated phase conductor. If there is any mechanical damage to the conductor, the neutral will short against the phase conductor, opening a path to ground which should provide sufficient fault current to trigger the circuit breaker.
  - Expensive and hard to handle.
  - Deadending and making a connection are difficult unless used with specifically designed deadend grips and connectors.



**Fig. 23. Concentric neutral conductor.**

## Overhead vs. Underground

Secondary distribution lines and service drops can be installed either overhead or underground.

Underground distribution seems an attractive option for a number of reasons:

- It eliminates the need for poles, which can be one of most costly components of a LV distribution system. In its place, it requires digging trenches in which the conductor is laid, a task that can easily be undertaken by the villagers themselves as one of their sweat-equity contributions to their electrification.
- It is aesthetically more pleasing, doing away with wires and poles scattered around the village.
- In areas susceptible to storms such as typhoons or cyclones, an underground distribution system is less exposed to the elements—winds, ice, and tree branches—and therefore less vulnerable to outages. Because of the increased life-cycle cost associated with using poles (if they have to be occasionally replaced), this cost might exceed the cost of underground construction. Underground lines are also less susceptible to tampering or to presenting a hazard to individuals.
- Overhead lines require removing trees along a sufficiently wide right-of-way to avoid their possibly damaging the line. This task can be even costlier if the line passes through plantations of, for example, coconut trees because trees that are removed represent a loss of food and/or income



to their owners. In addition, vegetation growing in the vicinity of the lines must periodically be trimmed. Use of underground line eliminates these problems.

But there are also disadvantages associated with the use of underground construction:

- Locating and repairing underground faults, should they occur, requires specialized equipment and training.
- If additional capacity will be required to meet increased consumer loads in the future, the capacity of underground lines cannot easily be increased either by adding another phase conductor to a single-phase line or by upgrading the conductor size.
- When new homes are built along an existing line, making joints along this line to serve these new consumers is considerably more difficult and requires specialized training.
- Because underground conductors are exposed to moisture, rodents and insects, damage from construction of other underground facilities such as water lines, it is essential that only high quality materials, specifically designed for underground electrical distribution be used. This increases cost and can slow project construction.
- If the village is located in rocky terrain, digging trenches will be difficult and slow.

But in the end, it is usually the cost argument that holds sway: under most circumstances, underground is still considerably costlier than overhead distribution because of the need for reliable insulation. And because as high a connection rate as possible is needed to maximize the potential impacts of electrification and ensure the maximum number of connections to reduce unit costs, reducing cost of electrification assumes a high priority. It is for this reason that overhead lines are still the most commonly used option for rural electrification.

## Conductor sizing

For consumers to benefit from electrification, electricity must be transmitted over distribution lines from the power supply to these consumers. And because the conductor used for these lines is one of the more expensive components of a mini-grid, there is an incentive to make electrification more affordable by using a smaller, cheaper conductor. However, in the process of transmitting electricity, resistance in the conductor leads to a drop in voltage along the line and to an associated loss of power. Reducing conductor size can result in (1) poor quality of power at the consumer end of the line (low voltage and more pronounced voltage fluctuations) and (2) loss of power (due to resistive losses in the conductor). As is discussed in Chapter IV, low voltage can result in poor service (e.g., decreasing the light output of incandescent bulbs, making it difficult to ignite fluorescent tubes, or burning out electric motors). Loss of power along the line means extra power must be generated and paid for, if there is sufficient excess generating capacity in the first place; otherwise, fewer consumers could be served by that supply.

Assuming that the power supply is operating to specification, the size and type of conductor used for the mini-grid and, to a lesser extent, the power factor are the sole factors that determine whether an acceptable voltage can be maintained. The purpose for this section is to show how to calculate the required conductor size. But before this issue can be addressed, the following data is required:

- The first requirement for ensuring properly sized conductor is to establish the expected load the mini-grid is to serve. This is described in the section on demand assessment (p. 43) in Chapter IV. The proper performance of this task is important. Underestimating load will mean that the



with a more involved procedure relying on the use of a spreadsheet and considerably more calculations, although it lends itself easily to computerization. With two of these approaches, it is also possible to estimate the power losses that will be incurred along the conductor.

### ***Rough estimate of voltage drop***

While considerable time may be required to obtain a precise estimate of the voltage drop at the end of a line, this first method permits a very good approximation with little effort. Detailed calculations might seem worth the effort, but it should be kept in mind that estimates of load used to calculate the voltage drop are very approximate in the first place, regardless of the care with which this load estimates are made. Performing unduly accurate calculations with estimated numbers is not worth the effort. If carefully applied, both of the first two approaches described here should be sufficient to make a sufficiently accurate determination of the conductor size which would meet the conditions set for voltage drop.

This first method assumes that the load is more or less evenly distributed along the line. The more reality diverges from this assumption, the less accurate will this method be. For this approach, the maximum peak coincident loads for all consumers are simply summed and this value used in Eqn. (12) in Appendix 6. For the case illustrated in Fig. 24, the total load  $P = 5.8$  kW. This equation leads to the following:

$$\%VD = ((2.26)(0.9) + (0.32)(0.44)) \frac{(5.8)(0.30)}{(230)^2 (0.9)} \cdot 10^5 = 7.9 \%$$

Because this is too high, the next larger conductor size (21 mm<sup>2</sup>) must be tried:

$$\%VD = ((1.41)(0.9) + (0.32)(0.44)) \frac{(5.8)(0.30)}{(230)^2 (0.9)} \cdot 10^5 = 5.2 \%$$

This maximum voltage drop of 5.2 % is acceptable.

The dependence of power loss on actual current in each span varies as the square of that current. If the load seems more or less uniformly distributed along the line, Eqn. 13 can be used to give a rough estimate of power loss in the line:

$$P_l = \frac{2}{3} (0.30)(1.41) \left( \frac{5.8}{(230)(0.9)} \right)^2 \cdot 10^3 = 0.22 \text{ kW}$$

### ***A more accurate estimate***

This second method can be used whether or not the distribution of customer load along a line is uniform. In this case, rather than simply summing the loads along the line, the product of the power taken off at each point along the line and the distance from the beginning of the distribution line to that point must be summed. This is done in the Table 6. Once this total has been obtained, it is substituted in Eqn. (15) to derive the voltage drop:

$$\%VD = 2((1.41)(0.9) + (0.32)(0.44)) \frac{(0.92)}{(230)^2 (0.9)} \cdot 10^5 = 5.4 \%$$

This voltage drop remains within the acceptable range.

This approach assumes that the voltage drop along this distribution line is small and that each consumer actually received close to the supply voltage. In reality, the voltage decreases slightly as one proceeds away from the power supply. Slight changes in consumer voltage in turn imply slightly increased or decreased current demand by each consumer, depending on the nature of the end-use, and this modified current would mean increased or decreased voltage drop due to these current changes. However, with a properly designed system with limited voltage drop, the error introduced is negligible for purposes of line design.

While this approach will calculate the voltage drop for a given conductor size, it is also possible to derive an equation to calculate the (aluminum) conductor size for a given voltage drop:

**Table 6. A good estimate can be obtained by deriving the weighted loading of the distribution line.**

Node	P <sub>n</sub> (kW)	L <sub>n</sub> (km)	P <sub>n</sub> x L <sub>n</sub>
12	0.60	0.300	0.180
11	0.20	0.275	0.055
10	0.60	0.250	0.150
9	0.40	0.225	0.090
8	0.60	0.200	0.120
7	0.60	0.175	0.105
6	0.20	0.150	0.030
5	0.80	0.125	0.100
4	0.00	0.000	0.000
3	0.40	0.075	0.030
2	1.00	0.050	0.050
1	0.40	0.025	0.010
<b>Total:</b>			<b>0.92 kW·km</b>

$$A = -Q + \sqrt{Q^2 + 39000 \frac{\cos \phi}{\sin \phi}} \text{ mm}^2$$

where

$$Q = \frac{\%VD E^2 \cos \phi}{300 P(\text{kW}) L(\text{km}) \sin \phi} - 242$$

If copper conductor were used, the required area would be  $A$  as calculated above divided by 1.6.\*

While the precise conductor size depends on conductor reactance that in turn depends on the frequency of the supply and equivalent separation of the conductors, the above equation represents an estimate with an assumed frequency of 55 Hz and equivalent separation of 0.30 m. Errors introduced for sizing mini-grids are minimal. Applying this equation to the previous case gives a minimum conductor size of 18 mm<sup>2</sup>, verifying once more that 21-mm<sup>2</sup> conductor is the proper size to use.

Unlike the initial approach which assumed a uniform distribution of loading along the line, there is not an easy way of estimating more accurately the power loss using the above approach. Use of a spreadsheet as is described below would have to be used for this purpose.

### Spreadsheet estimate

This approach is an alternative to that just covered and gives the same results for voltage drop. It also permits the calculation of the power loss along a line. It relies on dividing up the entire line into separate spans and calculating the line current, voltage drop, and power loss in each span.† For a *single-phase line*,

\* These equations are obtained by using Eqn. (10) in Appendix 6, substituting Eqn. (1) for  $r$ , substituting a linear approximation for  $x$  at  $f = 55$  Hz as  $x = 0.363 - 0.00075A$  (see Fig. 137) and solving the resulting quadratic equation for  $A$ .

† If the causal relationship between voltage and the current demand of each consumer is known, this can also be included in this model. **However, one should not blindly use Eqn. (4) for this purpose.** A decrease in the

Eqns. (4), (9), and (11) in Appendix 6 would be used, respectively. (For other configurations, the equations in Table 8 would be used.) Then the total voltage drop and loss would be obtained by summing the individual drops and losses. While basically a simple technique, it requires the use of a spreadsheet either completed manually or, preferably, by computer. However, while reliance on a computer can greatly facilitate determination of the voltage drop and power loss at any point in the system under a number of different scenarios, extreme care must be taken to ensure that all embedded equations in the spreadsheet are correct. Results obtained by the computer should always be checked against the estimates obtained using the very simple methods noted above, as there should always be close agreement if all equations have been properly applied.

The contents of each column included in the spreadsheet in Table 7 are explained below:

- Column (1): The number of each span, starting with the remotest pole, in this case span #12 that ends on pole #12. Spans are numbered consecutively outward from the supply, but with the furthest pole listed first.
- Column (2): The power taken off by spurs (i.e., service connections) originating from the pole at the end of that span.
- Column (3): The total load served by that span. This is the sum of the total load served by the spur(s) shown in the previous column plus the total load served by the next span(s) in the outward direction (the value found in the position located immediately above it, or “0” in the case of the first row).
- Column (4): The voltage at the end of that span. As an approximation, this is always set to the generation voltage.
- Column (5): The current flowing in that span equals the current in the next span(s) in the outward direction (found in the previous row) plus the current needed to serve the load in the spurs at the end of that span as calculated using Eqn. (4) in Appendix 6.
- Column (6): The length of that span.
- Column (7): The voltage drop in that span, calculated using the first part of Eqn. (9) in Appendix 6. The values inserted into that equation are those found in the same row, columns (5) and (6), along with the average power factor for the loads on that line and the values of  $r$  and  $x$  for the conductor being used along that span (which are shown at the end of Table 7).
- Column (8): The power loss in that span, calculated using the first part of Eqn. (11) in Appendix 6. The values inserted into that equation are the same as those used in column (7), except for reactance that does not affect power loss.

---

consumer voltage (due to voltage drop in the line from the supply) can cause either an increased or decreased demand for current, depending on the nature of the end-use. For example, at a lower voltage, a light bulb would draw less current while a motor might draw more current. Furthermore, the size and direction of the current change may not be as straightforward to calculate as may first appear. If the voltage supplied to a light bulb decreases 10 %, Eqn. (4) implies the current would increase 10 %. However, in real life, because a bulb is considered a resistive load, the current demand would be proportional to the voltage, e.g., a 10 % lower voltage would imply a current decrease of 10 %. To complicate matters further, at a lower voltage, the filament temperature is lower and its resistance increases, further decreasing the current. As a bottom line, no general approach exists that can be used to calculate actual current drawn by the consumer based on the nominal power drawn by the consumer.

**Fortunately, all these variation in current with changes in voltage are minimal, and assuming a constant voltage in the analysis does not introduce significant errors in conclusions drawn when sizing mini-grids.**

**Table 7. This spreadsheet layout is another approach for calculating voltage drop and power loss along a length of distribution line. The span is identified by the same number as the pole at the end of that span.**

(1) Pole (or span) no.	(2) Demand (kW) Spurs	(3) Main	(4) Voltage (V)	(5) Current (A)	(6) Length (km)	(7) Volt drop (V)	(8) Power loss (kW)
12	0.600	0.600	230	2.9	0.025	0.2	0.001
11	0.200	0.800	230	3.9	0.025	0.3	0.001
10	0.600	1.400	230	6.8	0.025	0.5	0.003
9	0.400	1.800	230	8.7	0.025	0.6	0.005
8	0.600	2.400	230	11.6	0.025	0.8	0.009
7	0.600	3.000	230	14.5	0.025	1.0	0.015
6	0.200	3.200	230	15.5	0.025	1.1	0.017
5	0.800	4.000	230	19.3	0.025	1.4	0.026
4	0.000	4.000	230	19.3	0.025	1.4	0.026
3	0.400	4.400	230	21.3	0.025	1.5	0.032
2	1.000	5.400	230	26.1	0.025	1.8	0.048
1	0.400	5.800	230	28.0	0.025	2.0	0.055
<b>TOTALS:</b>		<b>5.80</b>		<b>28.0</b>	<b>0.300</b>	<b>12.5</b>	<b>0.239</b>

Assumptions:

Power factor =	0.9
Resistance =	1.41 ohm/km
Reactance =	0.32 ohm/km

Each row is completed down to the first span. This is very quickly done using a computerized spreadsheet after the equations have been inputted. This spreadsheet indicates a voltage drop along the entire line of 12.5 V or 5.4 %, confirming the results of the previous approaches. The power loss during times of peak demand is more precisely calculated to be 240 W, confirming that the estimate made earlier was fairly close.

### ***Effect of conductor size on power loss***

While limiting the voltage drop is important in order for electrical appliances to operate as they are intended to, power losses can be important because they represent lost revenues to the system owner. In the example above, energy loss at peak times is about 250 W. If the system operates for only four hours each night and the load remains constant, this will, for example, consume 1.0 kWh nightly or about 360 kWh annually. If the system is supplied by a small diesel genset, this will mean that about 180 liters of fuel costing perhaps \$50 is wasted annually.

If one is trying to minimize cost, the question that must next be asked is whether spending more for a large conductor with fewer losses generates savings that are more than the cost of the larger conductor required to achieve this. For example, what would be the effect of selecting the next larger conductor size (34 mm<sup>2</sup>)?

Placing the new values for resistance and reactance for this new conductor into the spreadsheet in Table 7 will show a power loss of 150 W and a reduction in the voltage drop to 4 %. Supplying this power loss would require about 220 kWh, a reduction of about 100 W or 140 kWh annually. This would cost about

**Table 8. Equations for maximum percent voltage drop (%VD) and total power loss (P<sub>l</sub>) along a conductor for different line configurations and load distributions.**

Line Configuration	Balanced load of P concentrated at the end of the line		Balanced load of P uniformly distributed along the line		Voltage drop factor for a 50 % unbalanced load that totals P
	%VD	P <sub>l</sub> (kW)	%VD	P <sub>l</sub> (kW)	
<b>Single-phase</b>					
Two-wire	$Y$	$Z$	$Y/2$	$Z/3$	1
Three-wire	$Y/4$	$Z/4$	$Y/8$	$Z/12$	1.8
<b>Three-phase</b>					
Three-wire, delta	$Y/2$	$Z/2$	$Y/4$	$Z/6$	1.1
Four-wire, wye	$Y/6$	$Z/6$	$Y/12$	$Z/18$	1.5

\$30, resulting in an annual savings of \$20 from the previous scenario. However, increasing conductor size would increase the cost of that 300 m of conductor by perhaps \$40. Therefore, if the plant operates for more than two years under the assumed conditions, it would be cheaper to use the larger conductor.

In this case, using the larger conductor would not only be cheaper over a couple of years. It would also permit an increase in the size of the load in the future while still maintaining the voltage drop within acceptable limits (although with somewhat increased losses).

### **Generalized equations**

The equations used in the previous example are for a 2-wire, single-phase line. But as was mentioned in Chapter VI, several other configurations are possible and phases will likely not be balanced. The approaches for calculating voltage drop and power loss above can be applied in the same fashion to the other common configurations but with the slight modifications to the governing equation as shown in Table 8.

To use Table 8, the variables  $Y$  and  $Z$  must first be calculated as follows:

$$Y = 2(r \cos \phi + x \sin \phi) \frac{P L}{E^2 \cos \phi} \cdot 10^5 \quad \text{and} \quad Z = 2 r L \left( \frac{P}{E \cos \phi} \right)^2 \cdot 10^3$$

where

$P$  = total loading on line (kW), either located entirely at end or uniformly distributed along line

$L$  = length of the line (km)

$r, x$  = resistance and reactance (ohm/km, see paragraphs beginning on p. 223)

$E$  = nominal consumer voltage, i.e., 120 or 230 V  
 (for single-phase, three-wire: phase-neutral voltage)  
 (for delta configuration: phase-phase voltage)  
 (for wye configuration: phase-neutral voltage)

The percentage voltage drop and power loss in the first four column of data in Table 8 are for a balanced 3-wire, single-phase configuration and for balanced three-phase configurations. As an example of how voltage drop changes if loads are not balanced, the last column in Table 8 includes factors that must multiply the voltage drops for balanced loads (the first or third column of data) to obtain the maximum voltage drop for a 50 % unbalance in loading (for the meaning of a 50 % unbalance, see the footnote on p. 57).\*

Using these equations, Box 5 provides a graphical solution for conductor size under the conditions noted.

### Stringing and sagging the conductor

After the most appropriate type and size of conductor, pole, and poletop hardware have been selected for a specific application and the poles, poletop hardware, and any necessary guys have been properly installed, the conductor must be strung. This involves placing the conductor in position, tensioning the conductor so that the tension does not exceed a certain percentage of its ultimate strength, and then fixing the conductor at each pole. Tensioning the conductor is referred to a "sagging" because tension and sag are directly related to each other; the proper horizontal tension "H" is generally determined by measuring sag "S" (Fig. 25).

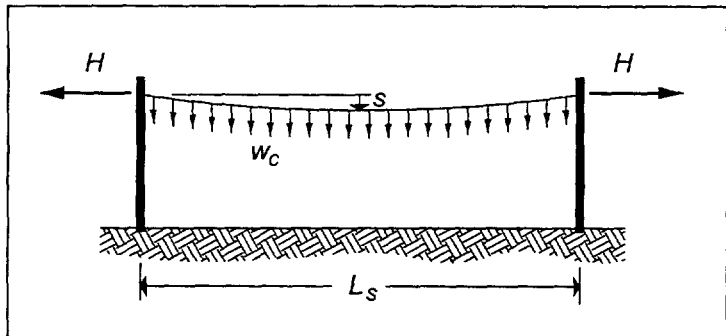


Fig. 25. Basic terms associated with sagging a conductor.

Before any work on stringing and sagging the conductor can commence, the appropriate sag tables must be obtained. For the more conventional types of conductor (ACSR, multiplex or ABC, etc.), the conductor manufacturer should be able to provide these. Examples are found in Appendix 8. If other conductor is used, it is necessary to establish the maximum tension that should not be exceeded and to calculate the sag associated with that tension (see next section). For example, in the U.S., the NESC limits the tension on ACSR conductor to 35 % of ultimate strength at 16 °C when it is initially strung and carrying no ice or wind loading.

Placing the conductor in place can be fairly straightforward with small conductor. However, as larger and heavier conductor is used, more care must be exercised. This section deals primarily with such conductor, although some points are common for all conductors.

\* Trying to balance loads along a distribution line means that, as one proceeds along that line, loads are connected to each phase conductor in such a way that the currents in these conductors at each point along the line are as close to equal as possible. This leads to negligible current in the neutral conductor (in cases when there is such a conductor, see Fig. 14b and 14c) and minimizes voltage drop along the line.



### Box 5. Estimating conductor size.

In the initial planning process, it is often necessary to obtain an initial estimate of conductor size for a specific project. The graphs below provide a quick way for using equations found in Table 8 to determine the conductor size required to keep the maximum voltage drop to within a desired range.

To estimate conductor size for a stretch of distribution line **operating at a nominal consumer voltage of 230 V (see p. 76 for definition) with loads balanced along the line, a conductor equivalent spacing of 0.30 m, and a frequency of 50 Hz**, either of the following three numbers will be required, depending on the actual situation:

4. If the load is concentrated at the end of the line, multiply the peak load (kW) by the length of the line (km) to get the kW·km loading,  $k'$ .
5. If the load is relatively evenly distributed over the entire length of the line, sum all the peak coincident loads (kW) and multiply this by half the length of line to get the kW·km loading,  $k'$ .
6. If the load is unevenly spread, sum the products of each load (kW) and its distance (km) from the beginning of the line to get the kW·km loading,  $k'$ .

To determine conductor size for a **single-phase, two-wire system** under the conditions mentioned above, look up the value  $k = k'$  on the appropriate graph (determined by the average power factor of the loads served), move vertically until the desired voltage drop is reached, and then move horizontally left (for aluminum conductor) or right (for copper conductor) to determine the value.

For perfectly balanced systems:

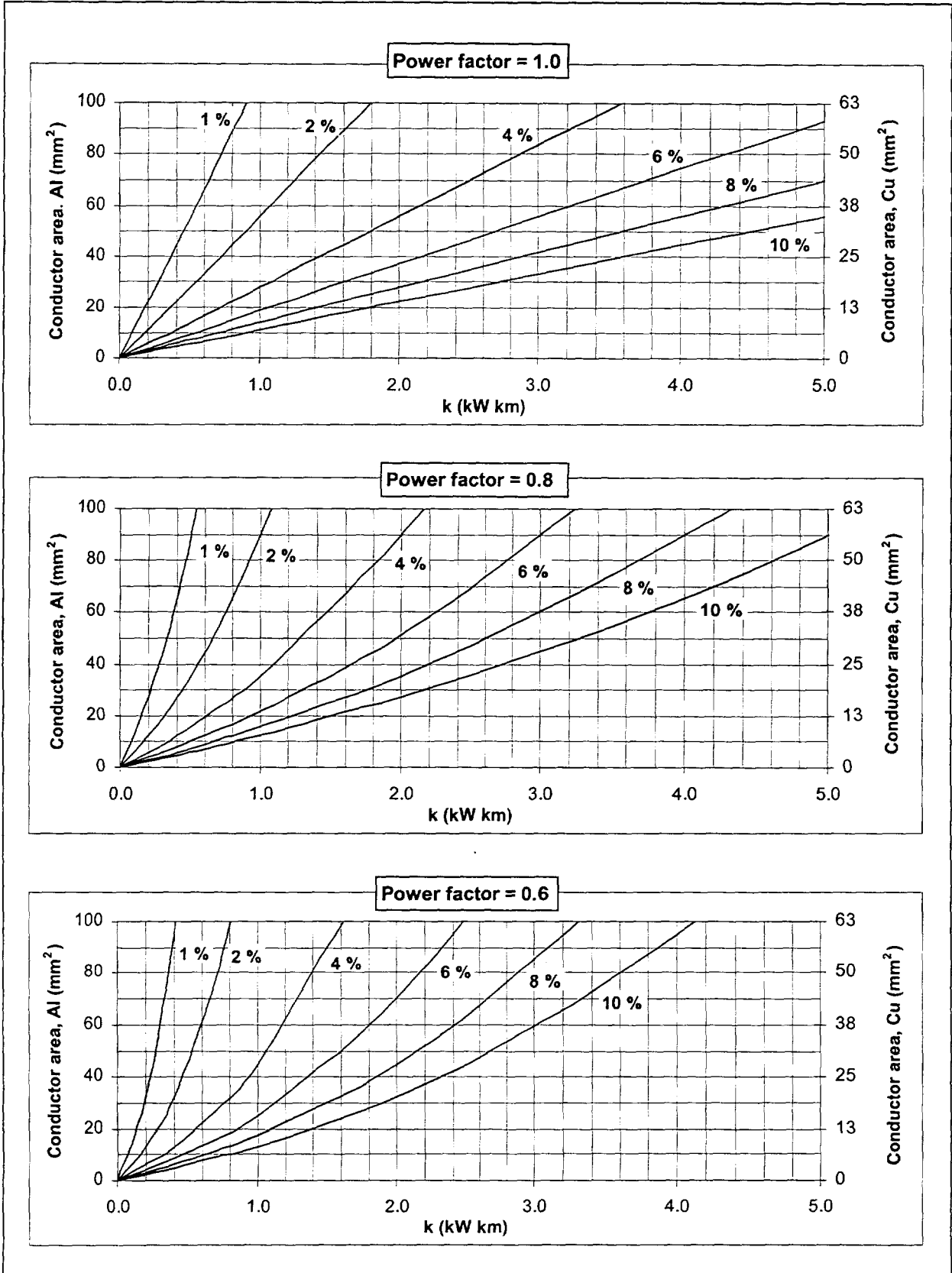
For a **single-phase, three-wire system**, use the value  $k = k'/4$  and follow the steps noted in the previous paragraph. For a **three-phase, delta system**, use the value  $k = k'/2$  and follow the same steps. For a **three-phase, wye system**, use the value  $k = k'/6$  and follow the same steps.

For systems with a 50 % load unbalance:

For a **single-phase, three-wire system**, use the value  $k = k'/2.3$  and follow the steps noted in the previous paragraph. For a **three-phase, delta system**, use the value  $k = k'/1.8$  and follow the same steps. For a **three-phase, wye system**, use the value  $k = k'/4$  and follow the same steps.

In preparing the graphs below, a distribution voltage of 230 V was assumed. To determine conductor size for another operating voltage, first determine the value of  $k$  as described above. Take this value of  $k$  and multiply it by  $(230/E)^2$ , where  $E$  is the nominal voltage being used by a single-phase consumer (defined on p. 76). Use this modified value of  $k$  and proceed to use the appropriate graph to determine necessary conductor size. Note that, for a given conductor, if the distribution voltage were reduced by half to 115 V, the load that could be served by this same line would be reduced to one quarter of the original load served at 230 V.

In preparing the graphs below, an equivalent spacing of distribution conductors of 0.30 and a frequency of 50 Hz were assumed. If either of these parameters are different for a specific situation, the impedance of the line  $x$  changes somewhat, but this will generally change the graphs only slightly. If a more precise value is desired, the equations in Table 8 can be used. The resistance and reactance for a specific conductor can be obtained for the graphs and equations found in Appendix 6 (beginning with p. 223).

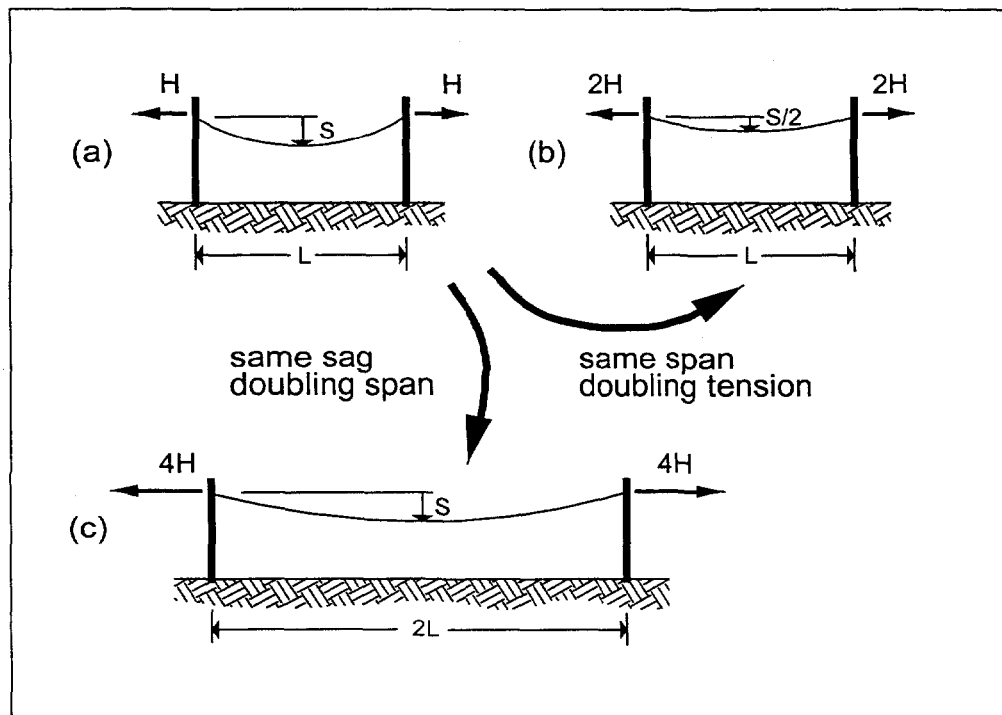


In planning for the stringing and sagging of larger conductor, it is necessary that sagging be done within several hours of pulling the conductor. This is because the conductor will begin creeping as soon as it is off the ground and the required sag will start to change. Creeping is the elongation of conductor under tension. As tension is applied to the conductor, it stretches and will continue to stretch until a balance between tension and the materials strength is reached. This process may take several years. With new conductor, if sagging is not completed within the recommended time period, it becomes impossible to accurately calculate the sag from sag charts, which only indicate "initial" sag and "final" sag. For example, it can be seen from Appendix 8 that, while the proper sag for a 70-m span of #2 ACSR triplex at 25 °C is 0.53 meters for new conductor, it increases to 0.75 m after creeping has completed. If there is too much time between pulling the conductor and tensioning or sagging this conductor, the required sag will be at some unknown value somewhere between these two sag values.

### Sag

The sag in a conductor is determined by the weight and tension of the conductor and its span. The relation between these three parameters for a given conductor is illustrated in Fig. 26. If one assumes that under a given tension, a conductor with a span of "L" has a sag of "S" (Fig. 26a), then keeping the same sag (and therefore ground clearance) while increasing the span will require placing the conductor under increased tension (Fig. 26b). If the tension then exceeds the allowable value, it can be decreased for this increased span by increasing the sag (Fig. 26c). If this reduces clearance to too low a value and the longer span is necessary, then a longer pole would be required.

For a given conductor type and size, the sag depends on the span according to the following relationship:



**Fig. 26.** For the same span, the sag is inversely proportional to the tension, see (a) and (b). To maintain the same sag, the tension in a conductor is proportional to the square of the span, see (a) and (c).

$$S = \frac{w_c L_s^2}{8.0 H}$$

where

$S$  = sag (m)

$w_c$  = weight of the conductor per unit length (kg/m or N/m)

$L_s$  = span (m)

$H$  = horizontal force at pole (either kg or N but must be the same as used in weight of conductor above). This is approximately equal to the tension in the conductor.

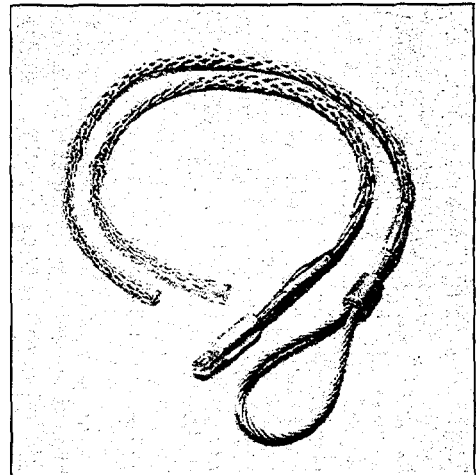
### **Handling and inspecting the conductor**

When receiving conductor to be used on a project, the reel and any protective covering on the conductor should be inspected for damage. A broken reel or damaged covering may indicate improper handling and possible damage to the conductor. When handling larger reels manually, they should be kept in an upright position and rolled. If necessary, ramps should be used to facilitate loading and unloading. During warehousing and transport, reels should be kept in an upright position at all times; otherwise, the lays of the conductor may overlap, causing possible damage to the conductor or delays in the stringing process.

### **Preparation for stringing**

Prior to stringing the conductor, the route of the line should be inspected to ensure all is ready for the pull. The right of way should be inspected for obstacles that may damage the conductor or complicate the stringing. If any obstacles cannot be removed, rigging may be required to ensure that the conductor is not damaged during the pulling process.

For larger conductor that is heavier and bulkier and involves handling greater forces in the stringing and sagging process, pulleys should be temporarily installed on each pole and inspected to ensure that surfaces are smooth and roll freely. The reel should be properly located with a stable base and positioned on the reel stand so that the conductor will unwind from the bottom. A leader line (rope) several dozen meters long is attached to the beginning of the conductor, usually by means of a wire mesh grip (Fig. 27), and threaded through the first pulley. This provides added safety to the pulling team, facilitates threading the conductor through the pulleys, and helps protect the conductor during the installation process. All guys should be installed and checked and poles inspected for proper positioning before pulling the conductor.



**Fig. 27. These flexible grips are comprised of a tubular steel mesh that is fit over the end of the cable. Under tension, the mesh tightens on the cable, increasing its grip as tension is increased. But it is easily removed once the tension is relieved.**

### **Pulling the conductor**

The conductor should not be payed out (removed) from a reel or coil that is not free to rotate; otherwise, each turn removed will leave one complete twist in the conductor that could eventually cause kinks. In all

cases, the reel should be mounted so that it is free to rotate. But it should not be allowed to spin freely, because this can cause the conductor to tangle on the reel, possibly damaging the conductor and delaying the process. It is also important to make sure the insulation is not damaged by dragging the multiplex over the ground or sharp objects, to avoid having vehicles cross or animals walk over the conductor, and to avoid kinks while paying out the conductor.

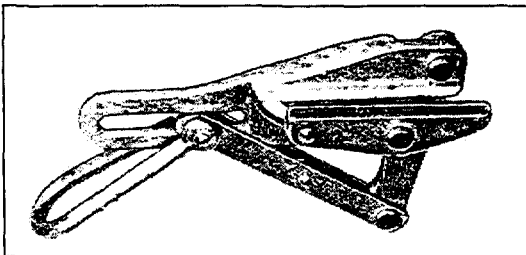
A couple of approaches for paying out the conductor from a reel are possible:

- The conductor can be paid out along the ground from a rotating reel that is moved down along the line, carried either by a vehicle or by a group of individuals, depending on access to the distribution line and the weight of the reel. Alternatively, the reel can be placed in the most accessible point nearest the section being constructed and the conductor pulled along the line. To avoid any damage to the insulator or conductor by dragging it across the countryside, villagers can hold on to the conductor at appropriate intervals, each carrying his or her section until it can be placed under its final resting place along the line. The conductor would then be carefully raised onto the insulators for final tensioning.
- With conventional distribution lines, pulleys are hung from the location on each pole where the conductor is to be mounted. A rope would then be passed through the pulleys and the end tied to the conductor on a fixed but rotating reel located at the end of the section being worked on. This rope would then be pulled over consecutive pulleys toward the beginning of the section, pulling the conductor along with it.

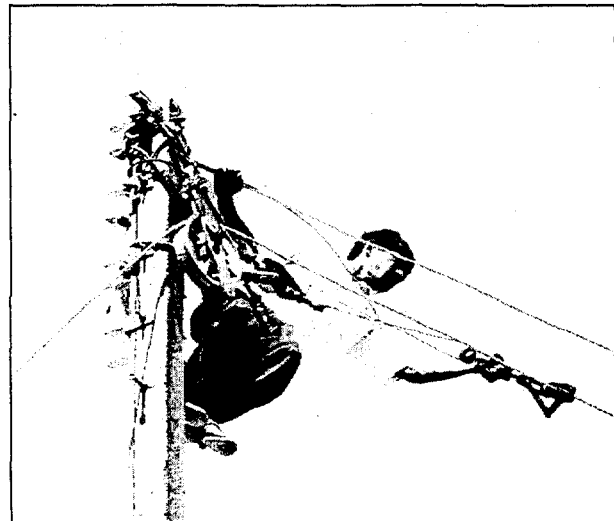
Once the conductor has been pulled, it should be deadended at one end so that sagging can begin with minimum delay. To minimize delay, the specific span to be sagged within the entire section being pulled should have been selected before pulling the conductor and measuring the temperature. In this way, the sag is known and work on getting the proper sag can proceed immediately.

To facilitate temporarily holding the conductor along its length, any of a variety of grips can be used. These hold the conductor while tension is applied, but they are easily removed once the tension is released (Figs. 28 and 29).

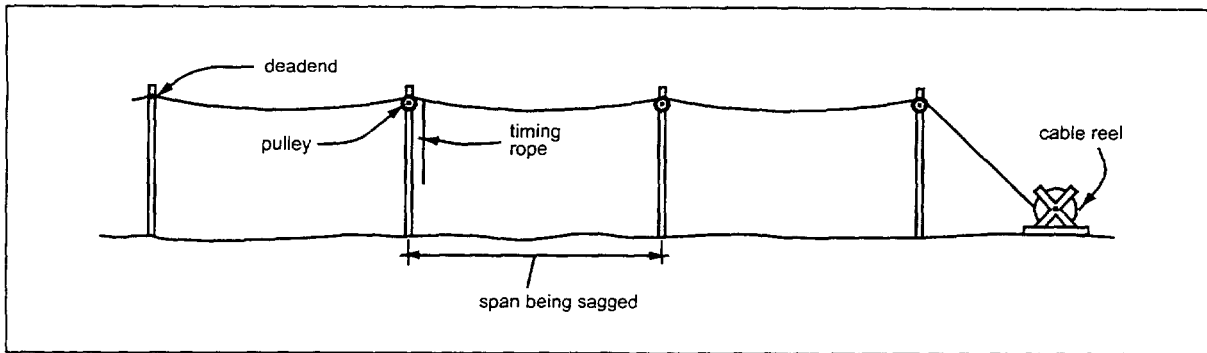
Before the conductor is tensioned, any pole that would be subjected to an unbalanced force must be suitably guyed to counteract the tension in the conductor that may cause the pole to otherwise bend over and break. This may be accomplished



**Fig. 28.** Grips of a wide variety of designs are used to temporarily hold a conductor.



**Fig. 29.** A grip is being used to tension a conductor passing through a pulley in a system in rural Nepal.



**Fig. 30. Once a section of line has been pulled over pulley, properly sagging one span properly sags the entire section. Timed sagging is one method for sagging longer spans. In stringing the conductor in this case, the rightmost pole should be temporarily guyed toward the right because the conductor under tension tends to force that pole to the left.**

by placing permanent guy wires and anchors in cases where this unbalanced force remains after the line has been fully strung. In cases where unbalanced conductor forces on a pole will disappear once the entire length of the line has been completed, a temporary guy wire firmly fixed to the bottom of a tree, a fence post, etc., can be used.

### ***Sagging the conductor***

The correct tensioning or sagging of the conductor is one of the most important phases of distribution line construction, especially for larger conductor sizes, and affects its reliability and longevity. If a conductor is sagged too tightly, it will cause the structure and conductor to fatigue. If all the conductors along a span do not have the same sag, the wind can cause them to slap together, causing outages and damage to the conductors. If it is sagged too loosely, it can become a hazard to the public because of the reduced clearance.

To determine the proper sag for a given span, it will be necessary to measure both the span and the temperature of the conductor at the time of sagging. To measure the temperature of the conductor, a thermometer should be placed directly against a piece of the conductor raised to poletop level. It should not be placed in direct sunlight as this will give a false reading. The temperature should be noted after the readings no longer change significantly.

As can be seen by referring to typical sag tables in Appendix 8, the temperature is important. Sag can change considerably with changes in temperature because the conductor expands and contracts as the temperature increase or decreases. For example, at an early morning temperature of 16 °C, a 70-m span of #2 ACSR triplex should have a sag of 0.48 m. But should conductor temperature rise to 32 °C in the middle of the day, this sag will increase about 20 % to 0.58 m. Close attention must be paid to the conductor temperature at the time of sagging.

For a given span and temperature, reference to sagging tables such as the ones in Appendix 8 will give the required sag under these conditions. The initial sag chart should only be used with new conductor that has never crept. (The final sag chart is to be used on conductor that has been removed from other lines and reinstalled. This chart is also used to check sag on existing line.)

After one span of a section of conductor has been sagged, it is not necessary to sag every span. Assume that the conductor has been pulled over freely rotating pulleys. Then, if the conductor is one span is

properly tensioned (as determined by its sag), the tension will be the same in every span in that section (Fig. 30). (Note that if the pulleys are freely rotating, the tension of the conductor in each span will be the same, but the sag will be different if the spans are of different lengths.)

As noted above, properly tensioning the conductor is necessary. Tensioning the conductor is more easily done indirectly by measuring the conductor's sag "S" in meters rather than directly measuring its tension "T". The two methods for doing this are the (1) sighting method and (2) the timing method.

### Sighting method

This direct method of sagging is the easiest, especially for multiplex and short spans. It requires nailing a lath or small board horizontally to the pole at either end of the span being sagged. These are nailed below the final resting place of the conductor (on insulators) at a distance equal to the required sag for that conductor, span, and temperature. Someone on the pole sights from one lath to the next and the tension of the conductor is adjusted so that the lowest point along the conductor coincides to the person's line of sight (Fig. 31). This is usually more easily accomplished if the person sighting the sag is back one span and is not on the same pole as the lath.

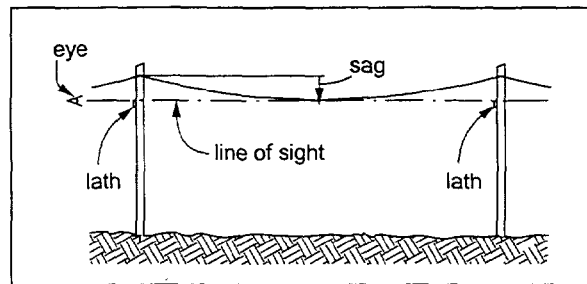


Fig. 31. Using two wooden strips (laths) to sight low point of span.

### Timing method

If a conductor is struck at one end of a span, a wave is initiated and travels down the span, bounces off the far support and returns back to the beginning. The time that this takes depends only on the sag in the conductor and not on other variables, such as span length, conductor type or size, and temperature. This fact can therefore be used to indirectly measure the sag of a conductor.

Assume that the section shown in Fig. 30 is to be sagged. For this purpose, a light rope is thrown over the conductor, a meter or so from the end of the span. If a section of several spans are being sagged, a middle span should be sagged. A wave is created by briskly jerking once on the rope, at the same time that the stopwatch is started. Each return waves can be felt as it passes the lightly held rope and is reflected back for its next trip down the span. This continues until the wave damps out sufficiently so that it can no longer be felt. The time for 3, 5, or 10 return waves is measured. The larger the number of returns that are clearly discernible, the better the accuracy. With longer conductors, the wave may dissipate more quickly, in which case a fewer number of returns might be timed.

From the recorded time for the wave to complete a given number of return trips, the existing sag can then be calculated:

$$S = 0.31 \cdot \left( \frac{t}{N} \right)^2$$

where

$t$  = time for N return waves (s)

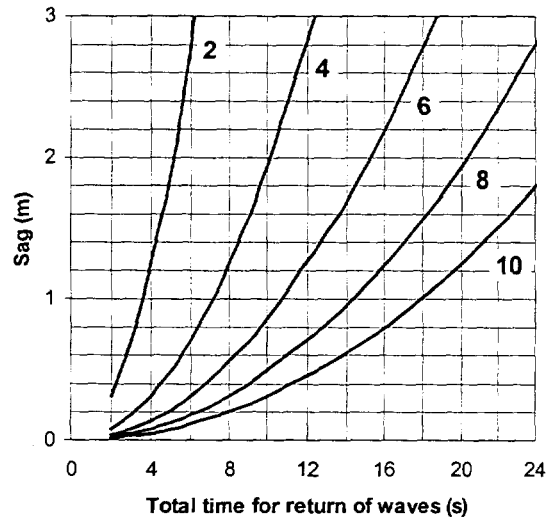
$N$  = number of return waves

A graphical solution to this equation is found in Fig. 32.

For the above equation to be correct, the conductor must be still, not be touching any object such as a branch, and have no joints along the span. In selecting a span to sag, the deadend span or spans with splices should not be used as these dampen the wave.

To calculate the required time for a properly sagged line, the actual measurement of the span to be sagged and the temperature of the conductor are applied to the sag charts such as those in Appendix 8. Then, from Fig. 32, the sag is converted to the time required for a certain number of return waves. The rope installed near the end of the span to be sagged is jerked to induce a wave and the time for that number of return waves is measured several times to ensure a reproducible result. If the time is too short or too long, the tension in the conductor must be reduced or increased, respectively. This process is repeated until the correct time (and therefore sag) is achieved.

Once all the conductors along one section of the distribution have all been sagged, the section can be deadended and the conductor secured to each insulator on the intermediate poles.



**Fig. 32. Chart for calculating sag from timing measurements. The number next to each curve represents the number of return waves included in the total time measurement.**



## VIII. Poles

---

If the distribution line and service drops are not placed underground (see p. 68), they must be supported sufficiently high off the ground to keep them out of the way of vehicular traffic and out of reach of pedestrians. This is necessary both to maintain the integrity of the line as well as to prevent the risk of shock to individuals who might otherwise accidentally come into contact with the conductors. These are the principal reasons for using poles and are the main factors determining their length.

In satisfying this purpose, it is necessary that these poles be strong enough to resist forces—such as those due to wind or the tension in the conductor—that would tend to bring them down, again affecting the integrity of the line and presenting a safety risk to villagers. Some of these forces, such as those associated with the tension in the conductors at a bend in the line, are permanent forces and are counterbalanced through the use of guys. The design and installation of guys is described in Chapter X. Other forces, primarily those arising from wind acting on the pole itself and on the conductors supported by the poles, change in direction and magnitude and are typically resisted by the strength of the pole itself.

To minimize project costs and safety hazards, poles must also be durable. While quality poles are likely to be costlier, their use will reduce the necessity of purchasing additional replacement poles and of reinstalling these and transferring the line from the old to the new poles. In short, more durable poles that will reduce life-cycle costs should be selected. Another reality to face is that, while considerable effort will be placed by the community in constructing a new mini-grid project, there will usually be less commitment to regular upkeep; the attitude will be that, unless it is really broken, there is no need to fix it. Meanwhile, safety may be compromised as poles degrade.

Poles of wood, concrete, and steel are commonly used to support the conductors, although other structures such as trees or supports constructed of angle iron and bars are occasionally used.

This chapter will cover the following topics:

- Types and attributes of poles commonly used to support distribution lines
- A review of clearance requirements, as this determines the required length of these poles
- A review of the forces that these structures should resist, as this determines the required strength of these poles
- Methods for setting poles

### Pole options

Poles are made from a variety of materials, with the most frequently used being of wood, concrete, and steel. None of these has a clear advantage in all situations; rather, the selection process should include the consideration of several criteria under site-specific conditions. These include availability, cost, weight and ease of handling, strength, and durability. Note also that in a single project, it might be advisable to use several types of poles. At the end of a span that has to be raised to provide sufficient access to vehicular traffic or that has to extend across a wide river or ravine, taller and stronger poles of concrete or steel construction might be more suitable. On the other hand, poles to support shorter service drops might be shorter wood or bamboo poles. At other places, if suitable live trees are found, these can be used.

Before proceeding with a review of pole options, one word of caution about poles in general should be noted. Because they can be the most expensive component of a distribution system, there is an incentive to minimize project costs by selecting the least expensive pole option. However, a less costly pole usually implies reduced strength and/or quality. This has several implications:

- Weaker, poorer quality poles and the conductors they support are more likely to fall under stress, resulting in a greater safety hazard to the population.
- Shorter life implies the need for additional investments when poles later will need to be replaced. In addition to the cost of new replacement poles, the community will incur the additional cost of removing the old poles, resetting the new ones, and reconnecting the conductors, guys, etc., all of which contribute to additional cost and hassle. It is also likely that the manpower and expertise will no longer be on-site when poles need to be replaced.

### **Wood**

Wood poles are widely used for electrification worldwide because they exhibit a variety of advantages:

- These are lighter than the equivalent concrete pole, the common alternative, and easier to handle in the field.
- Wood poles are not as susceptible to breakage during transport and handling.
- Wood poles can usually be field-drilled, permitting greater flexibility in the placement of mounting bolts and facilitating later modification.
- Wood poles are not adversely affected by airborne salt in coastal zones that can cause corrosion of the reinforcing steel in concrete poles.
- Local plantations permit self-sufficiency in the production of one of the costliest components of an RE program, creating employment, reducing the need for foreign exchange, and lowering the cost of RE.
- Larger, conventional wooden poles are easier to climb directly (with gaffs, sharp metal spurs affixed to the inside edge of a boot).
- Properly managed, wood is a renewable resource, requiring much less energy in the manufacture of poles and contributing no net carbon dioxide or other greenhouse gases, unlike those associated with the production of cement or steel for poles.
- Numerous environmental benefits are associated with increasing forest cover for pole production in marginal areas—reduced erosion of land and sedimentation that leads to the destruction of riverine habitats, improved ground water quality and quantity, more abundant and diverse wildlife, and opportunities for increased employment opportunities from processing a range of forest products. Forests also serve as a sink for carbon dioxide, a gas increasingly recognized as contributing to global warming and its adverse implications.
- In a number of countries, rural households have little disposable income and the problem facing an RE program is the inability of these households to cover the cost of connection as well as the cost of energy. Growing trees for poles may be one option requiring few financial and labor inputs that can reduce the cost of electrification. Although growing suitable trees requires perhaps a dozen years, it can eventually provide a regular income to rural households that, in part, can be used to cover the cost of their electric service.

Offsetting these advantages is the fact that untreated wood poles are susceptible to decay and insect damage. Tree species that are decay and insect resistant do exist but are not common. Local inhabitants should be able to identify resistant local species, but it needs to be verified whether this apparent resistance is for wood under ground-contact conditions and exposed to the weather. The inspection of fence posts or building timbers of the allegedly resistant species should be able to verify this.

In Bolivia, for example, a tropical species called *cuchi* (*Austronium Urundera*) is stripped of its sapwood and widely used for posts, poles, and building timbers. The heartwood of this species is extremely resistant to decay and insect attack but is, unfortunately, crooked. Some old-timers see this as an advantage and call them "balcony poles" because they can be located beneath a balcony since the crook will still place the conductors at a safe distance from the front of the balcony. A certain species of palms with a very hard outer shell has also been used as poles on the Altiplano.

The alternative to finding resistant trees is to chemically treat wood poles. This is discussed below.

In countries where the electric utility uses wood poles, criteria have usually been developed to provide guidance as to what specific characteristics to look for when selecting suitable poles.\* Generally, poles with the following characteristics are preferred:

- straight poles with little twist or spiral grain
- poles without large and/or numerous knots, as these weaken the pole
- adequate wood density as indicated by tree ring count (The width of the tree rings is an indication of the rate of growth of the tree, with wider spacing indicative of lower strength. In the U.S., with pine which is treated, rings spacing in the outer growth which average greater than about 4 mm indicates wood which has grown too quickly.)

In addition to the above, it is clear that poles should have sufficient girth to give them the required strength. This is further explained later in this chapter (p. 98).

### **Wood pole production**

An obstacle facing the widespread use of wood poles is that, in a growing number of countries, forests are disappearing or do not have suitable trees. It is possible to plant trees specifically for pole production, but adequate lead-time is required until newly planted trees can be harvested for this purpose. Tropical pines can produce a 9-m pole in about 15 years but have limited strength. Faster growing soft wood species exist but these tend to be weaker. More commonly found hardwood species such as eucalyptus, are another option, but these do not get very good preservative penetration and retention. However, because wood poles will continue to be in demand for expanding rural electrification as well as for replacing existing damaged poles, the need for poles will continue decades into the future, well after any tree plantation starts yielding trees of adequate dimensions.

On the national level, the advantages of wood poles and their production should be sufficient incentive for a national commitment to the creation of local tree plantations, possibly in collaboration with other government departments, non-governmental organizations, or private entrepreneurs.

---

\* An example of pole specifications are those utilized by the rural cooperatives in the United States. These can be found in the section "Electric program regulations and bulletins" located on the Web at <http://www.usda.gov/rus/regs.shtml>. This is the document "Specification for Wood Poles, Stubs and Anchor Logs" referred to as Bulletin 1728F-700 (formerly Bulletin 50-24).

For example, in the Philippines, the National Electrification Administration (NEA) recognized the numerous advantages of using wood poles in rural areas. It also realized the dwindling source of forest resources in its own country and the high cost in importing poles from overseas. Consequently, the Power Use Development Division of the Cooperative Services Department of the NEA initiated a tree-planting program in 1993. Nearly half of the 119 rural electric cooperatives in the country are now involved in this program.

These rural electric cooperatives raise seedlings that they donate to their consumers (either individuals or users groups) or sell under contract to large landowners. A condition for membership in some cooperatives is planting a couple of trees on the member's own land. The largest single area under cultivation presently is 400 ha. Upon maturity, the co-op agrees to purchase these trees for their eventual chemical treatment and use as wood poles.

Specifically for the Philippines, the NEA recommends planting *Gmelina Arborea*, *Eucalyptus Deglupta*, and *Acacia Mangium* which all can adapt to the varied climatic regimes in the country.<sup>6</sup> It is expected that a 35-foot (10.5 m) pole with a diameter of 8 inches (0.20 m) would be available after about 8 years following the planting of the seedling.\* The planting density is at least 500 trees per hectare. It is expected that the co-op will save roughly 50 % over the current price of imported poles. At an estimated development cost of roughly \$1,000 per hectare, NEA projects a 50-fold return on investment after 10 years.

### **Wood pole treatment**

One of the most characteristic features of wood species used for poles is the presence of two distinctly different types of wood within each stem: sapwood and heartwood. Sapwood, normally much lighter in color than heartwood, forms the outer periphery of poles, a layer which can range from a couple of centimeters to more than 10 cm in thickness, depending on the species. In living trees, the outer sapwood zone is where nutrient transport and storage occurs. Heartwood is found in the center of the stem. It is composed of wood cells that have ceased any active function and have gradually been filled with organic substances known as extractives. These extractives tend to darken the wood in this portion of the stem.

Heartwood is generally more durable than sapwood due to the presence of these extractives, many of which are toxic, to some degree, to the organisms which cause wood to deteriorate. Sapwood, in the absence of these extractives, is readily degraded by any number of wood deteriorating organisms, including fungi, molds, stains, and insects such as termites and certain beetle species. For this reason, it is essential to the longevity of wood poles that the outer, susceptible sapwood layer is protected from these organisms by the addition of preservative chemicals that make the sapwood unavailable as a food source. Proper application of these chemicals in the sapwood will enable the treated pole to last for an extended time in service.

Before poles can be treated, they must be properly dried. Green trees have a very high moisture content, often well above 100%. After felling and peeling, they gradually dry until their moisture content comes into equilibrium with the environment (at which time their moisture content is usually down to less than 30 %). This drying process is called seasoning. As the pole dries during seasoning, the wood shrinks and develops longitudinal "checks" on its surface. Depending on the character of the species, such checking can be very limited or quite extensive.

---

\* Although they are of useful size, what is left unclear is the strength of these poles after only 8 years of growth.

It is very important that drying be done properly, so that normal checking takes place before treatment. During treatment, all wood surfaces exposed in open checks are well treated. Subsequent drying of the treated pole in storage may open the original checks, but will not expose untreated wood. In a dry climate, poles can be adequately seasoned by natural air circulation, but care must be taken to avoid the onset of incipient decay or insect attack during the air drying process. Significant strength loss can occur with little visible outward sign of decay in such material. Poles can also be seasoned by artificial means, including kiln drying or steam conditioning, both of which, when done properly, sterilize the wood and kill any decay fungi present.

Three basic groups of wood preservatives are used to treat wood poles: oil-borne preservatives, and water-borne preservatives, and creosote. The major oil-borne preservative is pentachlorophenol, commonly referred to as “penta”. The major water-borne preservatives are chromated copper arsenate, commonly referred to as CCA-C, and ammoniacal copper zinc arsenate, also known as ACZA.\*

Creosote, a constituent of coal tar and a by-product of producing coke from the destructive distillation of coal for the steel-making industry, is normally used to treat poles through a controlled pressure/vacuum process. However, depending on the species being treated and the amount of sapwood present, some poles can be creosote-treated with an extended hot/cold soak.

Penta, a man-made chemical, is dissolved in a mixture of petroleum solvents and then impregnated in the pole by either a pressure treating process or in some cases, an extended hot/cold soak.

CCA-C and ACZA are comprised of several different water-soluble chemicals that are combined and then forced into the sapwood layer of poles during a pressure-treating process. The preservative is then chemically bound to the wood fibers, and once fixed, it cannot leach out into the ground. Due to the chemical nature of the water-borne preservatives, pressure treating is the only method than can be used with these chemicals to properly treat poles.

Without chemical treatment, many poles may not last beyond one year, especially in the warmer, moist climates. Their frequent replacement is costly and places an additional burden on those operating and maintaining a mini-grid. Furthermore, system reliability is reduced. However, with the proper chemical treatment and with careful quality control, poles can last for decades, even in wet environments. With a ground-line treatment procedure incorporated in a line inspection and maintenance program, this can be increased considerably.

The following paragraphs described the most common methods for treating poles.

### ***Pressure cylinders***

Conventionally, wood poles are treated in large, centrally located treatment plants. They are first properly dried and then, when the moisture content has decreased sufficiently, they are treated in a pressure cylinder. Several procedures are possible:

- Empty cell method: In the pressure method, the flooded cylinder is placed under considerable pressure to force the preservative into the wood. This provides deeper and more uniform penetration of the preservative, higher absorption of the preservative, and more effective protection than obtained with other methods. After penetration, a vacuum can also be drawn to

---

\* These variants of the arsenate preservative are preferred because they exhibit less conductivity when the pole gets wet.

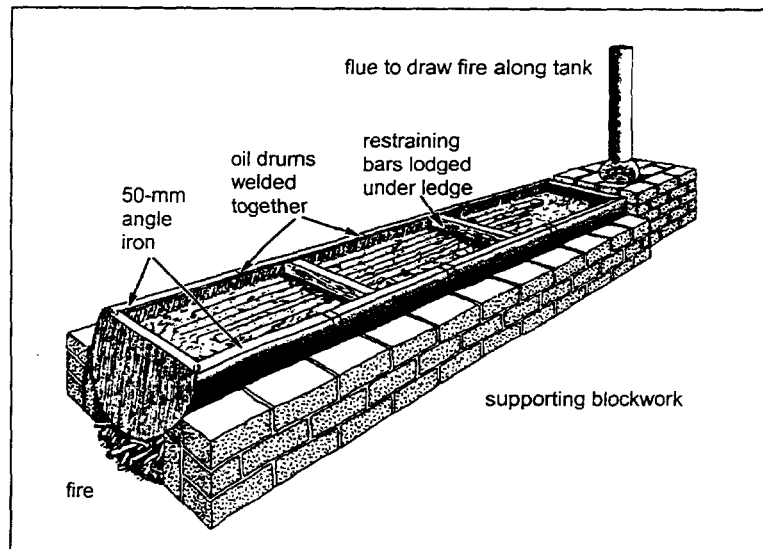
recover some of the preservative. This still leaves the cell walls coated, but the cells only partially filled.

- Full cell method: In the double-vacuum method, the timber to be treated is placed in a sealed cylinder and a vacuum is drawn. The cylinder is then flooded. As the vacuum is released and the pressure within the cylinder increases, usually to atmospheric, preservation is sucked up in the wood. After a period of soaking, the preservative is withdrawn, and a final vacuum is drawn to recover some of the preservative that had been absorbed by the timber.

Although typically large, small units have also been built.<sup>7</sup> Being smaller in size, they might be built at scattered points in the country where rural electrification projects are being implemented. For electrification in more remote areas, the advantage of growing trees locally is largely defeated if these then have to be transported long distances to these centrally located plants. Other options are required.

### *Hot/cold soak*

One method that is probably the more readily available in less-developed countries is the hot/cold soak approach (Fig. 33).<sup>8</sup> Rather than applying pressure to force preservative into the poles or drawing a vacuum to draw the preservative into the wood, it relies on a partial vacuum within the wood induced by varying the temperature of the preservative in an open tank. However, this method must be used with caution as one is dealing with hot, toxic preservatives and subject to exposure to large volumes of vapor from these heated preservatives. Pollution of the local environment is also possible if care



**Fig. 33. The hot/cold soak method for treating poles.**

is not taken in handling the preservative, the treatment process, and the treated poles. Because of the nature of the process and the inability to carefully monitor all the variables, the results are inconsistent.

Seasoned wood contains minute air spaces that usually amount to slightly more than half the volume of the wood. When wood is placed in a preservative that is then heated, the expansion of the air that accompanies its increased temperature forces some of it to be expelled. Then on cooling, the remaining air contracts and the preservative is drawn into the wood. Typically, the preservative is heated to 85 ° to 95 °C, maintained for about an hour and then let to cool before the poles are withdrawn.

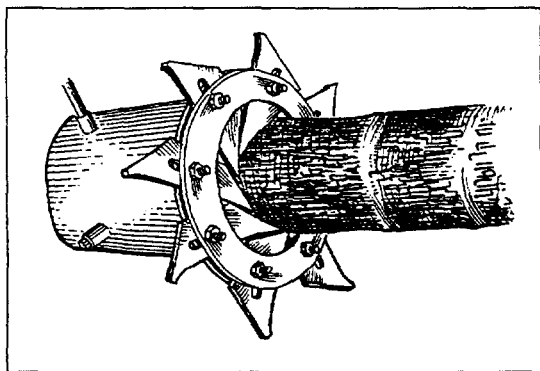
The amount of preservative absorbed depends on the species and size of wood being treated and is controlled by the difference in these temperatures used for the treatment. As with the other methods described above, after penetration, excessive preservative can be recovered by removing the poles before the preservative has completely cooled. Or heat can be applied a second time and then removing the poles 1 to 3 hours after it has been in the hot preservative.

This process can be used with any preservative that will remain stable when heated, with creosote-type preservatives being the most commonly used. The arsenate water-borne preservatives cannot be used with this method because the salts precipitate out under high temperatures. For other preservatives which contain inflammable solvents or are liable to decompose on heating, a variation of this method is used whereby the heating of the wood and the absorption of the preservative are performed separately. First the wood is heated for 1 to 2 hours using hot air, steam, or water. The wood is then quickly transferred to a tank of cold preservative where it is absorbed while cooling. Arsenate preservatives would again not work in this situation, because the salts would precipitate on touching the hot exterior of the wood, preventing the absorption of the preservative.

The plant required for this treatment can be easily made locally. Oil drums are cut longitudinally and welded to form a long trough as shown in the figure. These tanks must be suitably stiffened and supported to prevent bulging under the weight of the preservative and poles and the action of the heat. Some bars must also be used to ensure that the poles remain submerged during the entire process. Two disadvantages of this process are that it can consume considerable fuelwood and that contamination of the treatment area can occur if care is not exercised.

### ***High pressure sap displacement***

In the Philippines where rural electric cooperatives are growing their own poles, the Forest Products Research and Development Institute in Laguna has developed another device for the *in situ* treatment of wood poles through high-pressure sap displacement.



**Fig. 34. Adjustable steel fingers mounted on the pressure cap restrain the rubber seal when the preservative within the cap is pressurized.**

A cylindrical pressure cap is fitted over the base of a newly felled tree (Fig. 34). A water-borne preservative solution is then introduced into this cap and forced up through the bottom of the tree. This forces the sap out, leaving the preservative behind. Up to two poles can be treated simultaneously, with treatment times of up to several hours, depending on a range of variables. The treating equipment cost \$5,500 with a 1/3-hp electric motor and \$8,200 with a 2-hp diesel engine.<sup>9</sup>

Presently, several dozen rural electric cooperatives and entrepreneurs are using this treatment plant in the Philippines, each plant having a production capacity of about 10 poles daily. *Gmelina arborea*, a light, rapidly growing hardwood, is commonly used and harvested after seven years. By this time, poles have attained a height of about 10 m length and a diameter of 220 mm.

Treatment is with CCA, with a retention of 12 to 17 kg per cubic meter and full penetration of the sapwood. To minimize environmental problems and ensure quality treatment, the operation should be carefully managed.

A small version of this device that is hand-powered has been developed which is used to specifically treat bamboo. It is still not too labor-intensive, as two or three people are sufficient to do the treatment. Treating time is 1 to 2 hours, depending on the moisture content of the bamboo.

### ***Other approaches***

As opposed to sap displacement described in the previous paragraphs, a sap-replacement option is also possible. This treatment has been applied to freshly-felled bamboo. The butt end of the pole is soaked in a container of preservative, allowing the preservative to diffuse from the base of the bamboo to the tip of the leaves via transpiration. This treatment takes about 4 to 5 days, depending on the sunlight that will help in the transpiration.

It is also possible to immerse dried bamboo in the preservative solution and let the preservative soak in over a certain period of time.

A common approach to increasing the life of buried poles is to paint the base with bitumen. Another approach is to soak in sump oil the portion of the pole to be buried. However, it is not clear how effective these approaches are, if at all.

Because the principal problem of insect damage and decay occurs around the ground line of the pole, where moisture and oxygen provide optimal conditions, another solution sometimes used is to prepare concrete foundations poured on-site or carried in. Poles are then clamped to this base (Fig. 35).

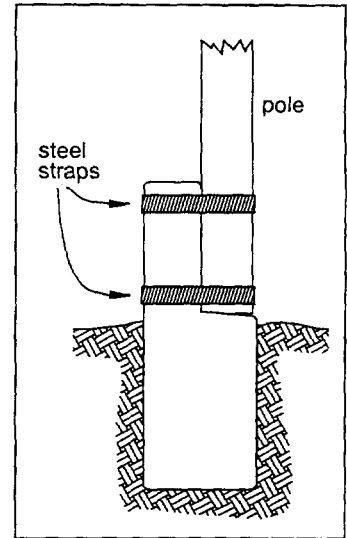
Poles first decay at the ground line, while the above portion it is usually much less affected by decay. Therefore, at several sites, once poles started decaying around the ground line, the solution was to simply cut off the decayed portion and rebury the remainder. The disadvantage of this stop-gap approach is that, unless poles were previously oversized, line-to-ground clearance may be reduced to below what is needed to provide for adequate safety to pedestrians.

### **Use of trees**

To properly support lines, wood poles must be adequately treated to prevent decay and insect damage; properly guyed to counteract permanent forces acting on the line; and adequately sized and properly set in the ground to offset temporal forces acting on the poles, arising primarily from the wind. Living poles—trees—can be an option that transfers on to nature the cost and effort of guying, setting, and protecting against decay.

It is necessary to use healthy trees, with no dead branches, for this purpose. Since trees with abundant foliage can easily catch the wind, the trees should have sufficient rigidity to prevent large displacements when the wind is blowing. Line insulators can be mounted on the main trunk and branches and foliage around the line cleared. The tree's lower branches should be trimmed to discourage children from climbing and playing on the tree.

Around the world, various trees are used as "living fence posts". Cuttings are placed in a row and grow into fence posts that can periodically be trimmed. This raises the questions of why "living power poles" cannot also be planted. In Laos, for example, teak trees are being grown throughout the country (Fig. 36). It would appear that, while poles can be installed for a mini-grid project, it may also be possible to plant suitable trees at strategic locations under the lines. When these trees have grown to a suitable size, the



**Fig. 35. A concrete post supporting a wood pole eliminates the problem of decay and insect damage at and below the ground line.**



lines could be transferred to these trees. If mini-grid is superseded, the poles can then be used as a source of timber.

### Concrete

Where wood poles are not an option because suitable poles are not grown or available locally, steel-reinforced concrete is an alternative. This permits local manufacture with relatively inexpensive, readily available materials—cement and reinforcing steel. However, the manufacture of concrete poles is subject to the need for good design, quality materials, and competent execution. And a major disadvantage of concrete poles is their weight and the subsequent difficulty in handling, moving, and installing them, especially in areas with no vehicular access. They are more susceptible to cracking or breaking than wood poles.

Because concrete has little strength in tension, steel is embedded in the concrete to provide this strength. Forces imposed by external loads are transferred from the concrete to the steel through a bond between the two. This bond is formed by the chemical adhesion which develops at the concrete-steel interface, by the natural roughness of the surface of hot-rolled reinforcing bars, and by the closely spaced, rib-shaped surface deformations on the bars which provide a high degree of interlocking of the two materials.

If poles are cast in the village, simple reinforced concrete poles are the most commonly made. Prestressed concrete poles are preferred because they are lighter and are almost always used commercially. However, because their manufacture requires prestressing the reinforcing steel, this is more difficult to do in a rural setting where the appropriate equipment and quality control are not available.

- **Cast reinforced concrete:** This is the easiest and least costly design but one that yields the poorest strength characteristics. Reinforcing steel or "rebar" is simply placed in the forms prior to pouring the concrete (Fig. 37). Reinforcing steel has no initial stresses; these stresses only develop as the structure is placed under load. As the structure begins to deflect, a portion of the concrete is placed under tension and can begin to develop hairline cracks before the steel begins to provide the necessary tension to counteract the imposed load. This design may also be subject to voids or variations in density,



Fig. 36. Straight, well-formed teak trees seem to clearly suggest their suitability as power poles.

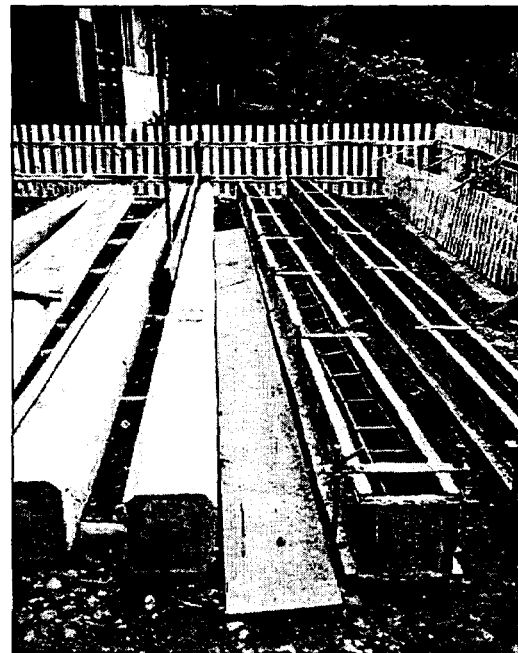


Fig. 37. Steel reinforcement placed in a mold ready for casting at an isolated site in Indonesia. Completed poles at the left are curing. (Photo credit: Mark Hayton)

depending on the actual manufacturing process used.

- **Cast prestressed concrete:** In this design, the reinforcing steel is prestressed and is under tension even before the structure is placed in use. However, special prestressing steel—in the form of either wire, cable, or bars—with several times the tensile strength of reinforcing steel must be used.

Pre-tensioning and post-tensioning represent two alternatives for prestressing the steel. However, only pre-tensioning reinforcement is used in the production of poles. In this case, the prestressing strands are tensioned between well-anchored abutments in the casting yard prior to placing concrete in the beam forms. The concrete is then poured around the tensioned strands. After the concrete has attained sufficient strength, the strands are cut. As they try to collapse back to their original length, the prestressing forces are transferred to the concrete through the bond and friction along the strands, chiefly at the outer ends.

Development & Consulting Services (DCS) in Butwal, Nepal, has researched and developed utility poles made both of reinforced and prestressed concrete for manufacture in remote locations. Because timber is increasingly difficult to find in the country, concrete seems an attractive substitute.

Their reinforced concrete poles are 7 m long, with a 200-mm square cross-section at the base, tapering to a 130-mm section at the top. They weigh about 540 daN (a deca-newton is approximately equal to 1.0 kilogram-force) and are designed to accommodate the equivalent of about 200 daN applied near the top.<sup>10</sup> On-site manufacture of these poles was attempted in at least two locations with mixed results because of quality of the poles. In one case, field results seemed satisfactory; in the other, on-site manufacture was abandoned (Fig. 38).

DCS also developed a mechanism to manufacture prestressed poles in the field. The poles made in a lab setting with this device were 8.0 m long, with a 100 mm x 260 mm cross-section at the base, tapering to a 100 mm x 120 mm section at the top. They weighed about 340 daN and were designed to accommodate the equivalent to a force of 140 daN applied near the top of the pole. The prestressed poles had some weight and cost reductions in comparison to similar reinforced concrete poles of about 30 % and 15 %, respectively.

While every effort was made to design prestressing equipment that was as light as possible, the estimated mass of the mould and tensioning frame was still 750 kg. This is due to the fact that the frame must be sufficiently rigid to withstand the force associated with prestressing or stretching 36 reinforcing wires running the length of the mould or a total force of about 50 tons. The equipment could be partially dismantled, but this still represented a considerable weight to carry to remote villages. Maintaining good control over the aggregate type and size distribution, water content, curing rate, degree of vibration, and grade of concrete to make full use of the prestressing are also expected to be difficult under village conditions. Prestressing the wire itself is not difficult but would also require personnel who are adequately trained, able to follow technical instruction, and capable of making accurate measurements. Because each device only permitted



**Fig. 38. In addition to weight, weak poles due to the lack of properly graded aggregate and poor compaction of the concrete were other reasons that discouraged their use in Gotikhel, Nepal.**

the construction of one pole at a time and a good part of a week was required for the pole to cure before detensioning the wires, considerable time and staff would be tied up in the field making poles for a project.<sup>11</sup>

In short, while concrete poles are an option, they are clearly not an easy option. One of the biggest problems even after poles have been manufactured is that they are difficult to carry in areas off the road. Furthermore, raising poles is also difficult and can represent a real risk to those involved in this process (Fig. 39). Few who have been through the process would like to repeat it. However, in cases where no clear alternative exists, those who have to make and use concrete poles eventually find a way of managing the tasks of transporting and raising the poles.



**Fig. 39. A gin pole being used to raise a concrete pole.**  
(Photo credit: Jon Katz)

### **Steel**

When the grid has to be constructed in an area without vehicular access, where suitable trees cannot be found and where concrete poles cannot easily be made or transported, an alternative has been to use steel poles. Their construction permits a pole to be fabricated of smaller sections that can be easily transported, by porter if necessary, and assembled on-site. Strength of steel is predictable and steel poles can be designed and manufactured to more exacting tolerance. It is susceptible to corrosion (rusting) and appropriate precautions must be taken, including galvanizing or painting.

One design for such poles originated from the work of Nepal Hydro & electric Pvt. Ltd. of Butwal (Fig. 40). Slightly tapered tubular poles are made up of sections fabricated of 1.5- and 2-mm plate, each with a length of 1.25 or 2.5 m, and galvanized with a zinc coating of about 600 g/m<sup>2</sup>. For transport and storage, sections are placed inside each other. Each section weighs from 4 to 60 kg, permitting one or more pole sections to be carried by a single individual. Assembled, these become poles with lengths of 5 through 17 m. Cost are about \$1.30/kg. For example, a lighter-weight (i.e., 1.5 mm construction except for the base section) 10 m pole costing \$130 can handle a maximum permissible transverse poletop load of 130 kg without guys. A heavier-weight and slightly longer, 10.6-m pole costing \$310 can handle a maximum load of 540 kg.



**Fig. 40. Poles fabricated in Nepal can be easily carried by porters in sections to isolated villages.** (Photo credit: Dale Nafziger)

Another approach to design is utilized for 11 kV and LV lines in India. Poles with a length of 7.5 or 8.0 m are assembled from two rectangular steel sections of different cross-section inserted about 0.2 m into each other. They are joined by bolts as shown in Fig. 41. The larger section weighs no more than 60 kg. These poles are designed for a maximum working poletop load of up to 200 kg and are painted with red oxide primer coating to prevent rusting.<sup>12</sup>

A simple variant of this that has been adopted in several projects is to use 6-m lengths of standard galvanized pipe at least 50 mm in diameter. In areas with difficult access, 6-m lengths are cut in half to facilitate transportation. On-site, a standard pipe bushing or coupling is then used to join the threaded end of each of the two sections together. The portion of the pole to be buried is painted in bituminous paint. To prevent rainwater from entering through the top of the pipe and leading to corrosion inside at the base of the pole, a pipe cap can be screwed at the top end of the pipe (but this requires that end to be threaded). An easier option is to invert an aluminum soft drink can over the top of the pole.

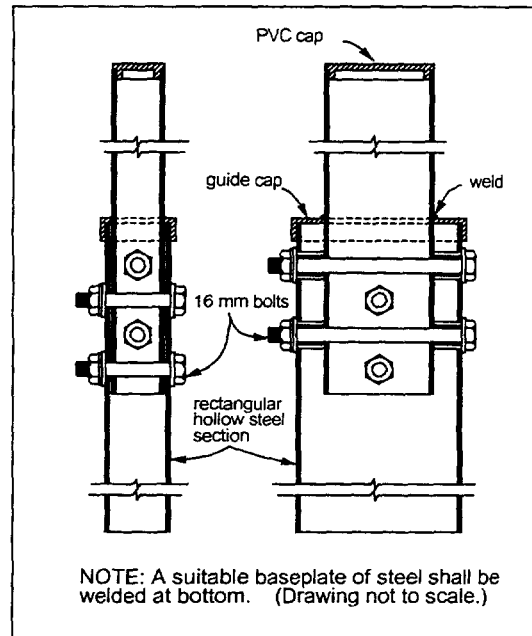
## Sizing

The two basic parameters needed to specify a wood pole are its length (determined primarily by clearance requirements) and its girth (determined by its strength requirements).

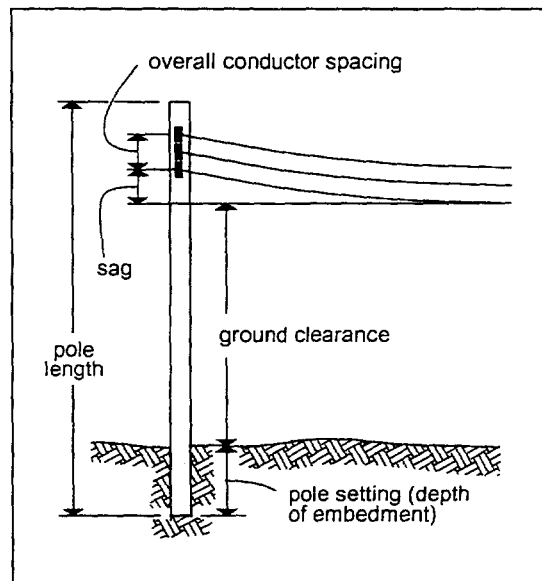
### Length

As illustrated in Fig. 42, the minimum length of a pole is determined as the sum of the following lengths, ordered by their relative contribution to the overall length:

- Ground clearance requirements to protect both the line and people.
- Depth that the pole is set in the ground to ensure a stable structure.
- Sag required to keep the tension within the conductor within acceptable limits within the typical temperature range encountered in the area.



**Fig. 41. A steel pole design prepared by the Rural Electrification Corporation of India.**



**Fig. 42. Factors entering into the determination of pole length.**

**Table 9. Minimum vertical clearances for low-voltage distribution lines, set by the NESC in the U.S.A.**

Clearance category	Neutral conductor	Insulated phase Conductor	Bare phase conductor
Areas traversed by vehicular traffic	4.7 m	4.8 m	5.0 m
Areas accessible on to pedestrians	2.9 m	3.6 m	3.8 m

- Top insulator to bottom insulator spacing at the pole (equivalent to the upper conductor to lower conductor spacing).
- Upper insulator to peak of pole.

The first three factors above, which generally figure predominantly in setting the length of the pole, are described in greater detail below.

### Clearance requirements

To ensure that the integrity of power lines is not compromised and that the lines do not present a hazard to people nearby, minimum clearances under various conditions are established. For example, as a point of reference, Table 9 indicated the minimum vertical clearances for low-voltage lines in the U.S.

In the case of a mini-grid, three categories might be suggested:

- The greatest clearances and therefore the longest poles are required where the line is located over road or trails where large vehicles are expected to pass. Such vehicles can have significant height. These include trucks that can be heavily loaded with produce from the field or busses carrying people and cargo on the roof. There are presumably national regulations concerning clearances under these circumstances and mini-grid designs should comply with these.
- Most poles used for the distribution line fall in the medium-height category. These often follow the roads, main trails, and paths within the community.
- The shortest poles or those requiring the least strength are those along the service drops, supporting small conductors where the lateral force on the pole is small. The selection and installation of these poles can be the responsibility of the consumers themselves, subject to certain safety requirements and verification before connection.

### Setting depth

As is discussed in more detail toward the end of this chapter (p. 102), a rule a thumb that is widely used for the depth a pole should be set into the ground is that this equal 0.6 m plus 10 % of the length of the pole.

### Sag

The amount of sag associated with a given conductor depends on the length of the specific span under consideration, the temperature of the conductor, the mechanical loading (i.e., wind and ice) on the line, and the factor of safety that has been adopted. This is described in Chapter VII (p. 79).

For a given conductor, the minimum sag that leads to minimum pole length can be obtained by increasing conductor tension as much as possible. But each conductor has an ultimate strength that cannot be

exceeded. In reality, to ensure that the capability of the conductor is not exceeded, the tension in the conductor is limited to some percentage (a safety factor) of its ultimate strength that is set by the electric utility (or a national electricity code if such exists).

For example, in the rural U.S., the NESC guidelines specify this percentage as 35 % of ultimate strength for ACSR conductor under “normal” conditions (at 16 °C with no wind). While this might seem like a large safety factor, it has been selected because actual maximum expected loading on the conductor and low temperatures would increase the tension to which the conductor is subjected. For example, under maximum loading conditions in areas without ice (i.e., with a conductor temperature of -1 °C, subject to a wind pressure of 440 N/m<sup>2</sup>, equivalent to a windspeed approaching 80 kph), the tension of the conductor should not exceed 60 % of its ultimate strength (equivalent to a safety factor of 1.7). Values for sag (and corresponding tensions) for a specific conductor for a given span should be obtained from the conductor manufacturer. Examples, specifically for multiplex, are those values given in Appendix 8. The values in this appendix are dependent on safety factors, mechanical loading, type of materials, weight of conductor, etc. Values of sag for the specific conductor and safety factors being assumed should be obtained from the manufacturer of that conductor.

Poles are one of the costliest components of a distribution system. This cost can be reduced by reducing the number of poles required; this would require increasing the spans. However, increased spans result in increased sag that reduces line-to-ground clearance. Therefore, longer poles may then be required to ensure adequate clearance. Therefore, there is a trade-off between pole length and number in order to get the least expensive line. But in densely populated areas in a village, pole spacing is typically determined by the location of the individual homes that are served from each pole (since mid-span taps for service drops are not recommended). These given spans would, in turn, set the minimum sags.

### **Girth**

There are three forces that may typically act on a power pole:

- The longitudinal (i.e., in the direction of the line) forces resulting from the unbalanced pull of the conductors.
- The lateral (i.e., sideways) forces due to two factors: the pull of the conductor on those poles where there is a change in the direction of the line and the force of the wind that, from time to time, acts on both the pole and adjacent conductors.
- Vertical forces resulting from the weight of the pole itself, the weight of the conductors, and the downward pull of any guy wires.

Longitudinal forces are best handled by balancing the tension in the conductors of either side of the pole when sagging (tensioning) the lines. Where conductors end on a deadend structure, guys are used to counteract this unbalanced force.

One component of the lateral force is caused by the tension in the conductor acting on the pole at those points where the line changes direction. This force component is permanent and, if it is more than the pole can handle, is counteracted by the use of a guy wire (Chapter X). The other principal component of lateral force is caused by the wind and is usually temporary in nature. The strength of the pole itself must be relied upon to counteract this force. This sets the required strength of the poles. If the pole were not sufficiently strong, two guys would be required, even along straight stretches of line, because the wind could blow in any direction. Because the strength of the pole alone is used to counteract this last force due to wind, this is the component that has to be calculated so that a pole of adequate strength is selected.

If poles are sufficiently strong to counter the lateral forces they will encounter, they are usually strong enough with regards to the vertical forces.

The forces arising from the pressure of the wind against the conductors and poles depends on the speed of the wind. For objects of cylindrical cross-section, a wind with the speed of  $V$  (km/h) results in a force per unit intercepted area of the following:

$$\frac{F}{A} = 0.05 V^2 \text{ N/m}^2 = 0.0010 V^2 \text{ lbs/ft}^2$$

The maximum design wind speed for several countries is shown in Table 10. Note that these maximum wind speeds are commonly found in flat, open areas. As applied to mini-grid distribution within a village, poles are often sheltered by homes and trees and generally experience reduced wind speeds.

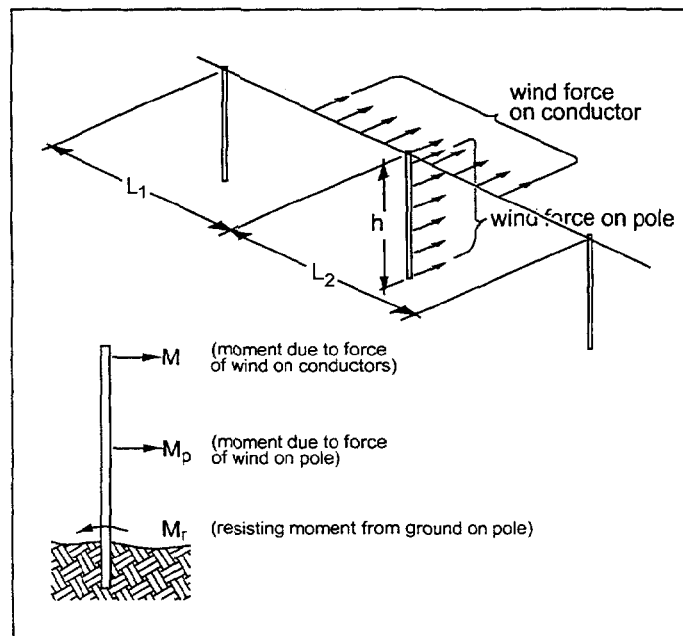
Figure 43 shows both the forces from the wind pushing against the pole as well as the forces acting on a portion of the conductor, forces that are in turn transmitted to the pole through its connection at the poletop.

The simplified equation below can be used to estimate the maximum average span which can be obtained when using a wooden pole of given type and dimensions. The complete equation as well as the derivation of the equation below are found in Appendix 5. The more complete equation in the appendix forms the basis for the design of conventional medium-voltage lines.

Mini-grids usually make use of shorter and smaller diameter poles, and the conductors are relatively more closely spaced on the pole than for medium-voltage lines. The moment due to the wind forces on the pole are smaller than those arising from forces on the conductor and can be overlooked. This permits a simplification of the final equation that is, in most cases, accurate enough to determine the maximum allowable span for a given pole:

**Table 10. Design wind speeds (km/hr) used in a couple of countries for deriving the design forces acting on conductors and poles.**

Country	Light wind regime	Heavy wind regime
Tunisia	82	95
United States	52	77
Bangladesh	100	



**Fig. 43. Forces on a pole due to the wind acting on both the pole and the conductors. For simplicity, only one conductor is shown.**

\* This assumes a drag coefficient of  $C_D = 1.2$ .

$$\bar{L} = \left( \frac{L_1 + L_2}{2} \right) = \frac{0.06 f c_g^3}{SF n d_c h V^2}$$

where

$\bar{L}$  = average span (m) as defined in the equation above

$L_1, L_2$  = spans lengths (m) of either side of pole as shown Fig. 43

$f$  = ultimate fiber stress of wood poles (see Table 11)

$c_g$  = circumference (m) of the pole at the ground line

$SF$  = safety factor (usually 2 to 2.5)

$n$  = number of conductors (or, when used as subscript, represents the number of the conductor)

$d_c$  = diameter of the conductor (m), with insulation

$h$  = exposed height (m) of pole

$V$  = design wind speed (km/hr)

**Table 11. Ultimate fiber stresses (N/m<sup>2</sup> or Pa) for typical wood species**

Species	Fiber stress
Southern yellow pine	50·10 <sup>6</sup>
Eucalyptus	70·10 <sup>6</sup>
Teak	70·10 <sup>6</sup>
Mangrove	90·10 <sup>6</sup>

If ABC or multiplex conductor is used, let  $n = 1$  in the equation above and let  $d_c$  equal the cross-sectional diameter of the bundled conductor.

In a typical village situation, homes are relatively densely placed and spans will be fairly short if the service drop to each consumer is to take off from a pole. This coupled with the small size conductor which is needed to serve a typical load imply that, based on this equation alone, a fairly small diameter pole would be required. This is illustrated in Box 6.

While the application of the commonly used equation implies that a small pole will frequently seem sufficient, several words of caution are warranted, with two of these illustrated in Box 6:

- Any decay or insect infestation that attacks the outer portion of the pole will have much more impact on the strength of small poles. Poles should be somewhat oversized to make allowance for this.
- A more important factor is sizing small poles under these circumstances may well be the need for adequate strength if the pole is to support the lateral force on it due to both the ladder and the technician fixing the secondary conductors to the poletop and then connecting the service drops.
- And finally, as is suggested in Appendix 9, it is not clear to what extent the strength of poles noted in Table 11 remains valid for small diameter poles.

Consequently, care must be exercised in using both the equation above as well as its more complete version in Appendix 5.



**Box 6. Calculating required pole diameter.**

Assuming that 50-m single-phase, two-wire spans of single insulated 25-mm<sup>2</sup> conductor with an overall diameter of 8 mm are to be supported on a southern yellow pine pole 6 m above the ground and that a maximum wind speed is set at 60 km/hr. A safety factor of 2.0 is selected. The equation relating average span to pole dimensions can be solved for the pole circumference and from there pole diameter at the ground line  $d_g$  can be determined:

$$c_g^3 = \frac{\bar{L} SF n d_c h V^2}{0.06 f} = \frac{(50)(2)(2)(0.008)(6)(60)^2}{(0.06)(50 \cdot 10^6)} = 0.011$$

$$c_g = 0.22 \text{ m} = \pi d_g$$

$$d_g = 0.070 \text{ m}$$

One concern with such small poles is that any decay or deterioration of the outer portion of the pole has a significant affect on strength. For example, if the outer 1 cm of this pole loses strength from decay or insect damage, the 7-cm pole would effectively be reduced to 5 cm of useful wood. With a reduction in its diameter to 70 % (i.e., 5/7) of its original value, the pole retains only  $(0.70)^3$  or one-third of its original strength. (As is shown in Appendix 5, the strength of a pole varies as the cube of its diameter or circumference.)

Another concern is that the pole may not be sufficiently strong to handle the force of a technician working at the poletop. For example, if a technician working on the line has a weight of 80 kg and a light-weight ladder is installed as shown below, the lateral force  $F$  acting on the pole would be at least

$$F = \frac{(80 \text{ kg})(1.0 \text{ m})}{6.0 \text{ m}} = 13 \text{ kg} = 130 \text{ N}$$

This implies that the resisting moment of the pole must be  $(130 \text{ N})(6.0 \text{ m})$  or 780 N·m. Reverting to the original equation for a pole's resisting moment in Appendix 5, the pole's resisting moment is expressed as:

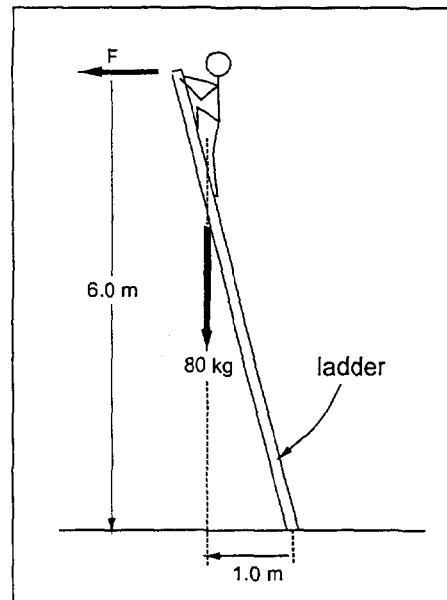
$$M_r = \frac{0.0031 f c_g^3}{SF}$$

and the required dimensions would be

$$c_g^3 = \frac{M_r SF}{(0.0031) f} = \frac{(780)(2)}{(0.0031)(50 \cdot 10^6)} = 0.010$$

$$c_g = 0.22 \text{ m}$$

$$d_g = 0.070 \text{ m}$$



This happens to be the same diameter as that required to restrain maximum wind forces on the conductor. If the pole had been sized for a smaller conductor, the calculated pole diameter would be even less than that required to support the technician on the ladder. This situation would have posed a safety hazard for the technician.

## Setting poles

Because it can be a costly component of a mini-grid and because it affects the operation and safety of a distribution system, the proper installation of poles is important. Two factors influencing the integrity of pole installation are the setting depth and the technique used for setting the pole.

The pole must be properly set in the ground to counteract two basic forces acting on the pole:

- Permanent but small lateral forces caused by conductor tension at small deviations in the direction of the main line (usually less than 5°) or by service drops off to either side. Permanent but large lateral forces caused by conductor tension at large deviations are countered by guys (see Chapter X).
- Temporary but potentially large lateral forces caused by the wind

The purpose for setting the pole is to distribute these forces over a sufficient area of soil to keep pressure within the soil to within what is allowable for the soil encountered. If this condition is not met, the pole will “kick out” of the ground. Greater resistance to overturning can be obtained by increasing setting depth. However, for a given line-to-ground clearance, this also requires a longer, more costly or more difficult-to-find pole. Alternatively, as is described below, cribbing or pole keys might be used.

The size of each pole is determined by the maximum forces it is designed to withstand. And each pole has an optimum setting depth. If the setting is too shallow, the pole would tip over and fall under these forces and the design girth (and strength) of the pole itself would not be used to full advantage, i.e., a smaller-diameter pole could have been used. If the setting is too great, this provides no additional strength; the pole will break before it can tip over and fall. Setting the pole too deep is therefore also counterproductive. Excavating the hole would require an additional effort, and the extra depth reduces line-to-ground clearance for a pole of given length.

Unfortunately, the precise depth for setting a pole is difficult to predict and is often determined by experience. Many uncertainties are associated with the effect of the soil on the pole and the wide variations in the capacity of a given soil.

A rule a thumb that is widely used for setting depth is that it should be 0.6 m (2.0 feet), plus 10 % of the length of the pole. A six-meter pole would therefore require a depth of 1.2 m. This depth may be increased somewhat in soft soil or if the poles are set on a slope. Research conducted at the beginning of the rural electrification period in the U.S. indicated that the diameter of the pole had negligible, if any, effect on the stability of the pole. This is because overturning of the pole is caused by the failure of the soil in shear and the areas of the shearing surfaces are largely independent of pole diameter.<sup>13</sup> (This was found to be true for the sizes of poles used on conventional systems. To what extent this is true for considerably smaller diameter poles is unclear. See Appendix 9.)

The diameter of the hole should be such that there is sufficient clearance all around the pole and all the way down to permit unfettered tamping of the backfill. If the hole is too narrow, backfilling cannot be properly done, leaving voids around the pole which will reduced its ability to withstand lateral forces. The diameter of the hole should be fairly uniform from top to bottom. Once the pole has been placed in position, small amounts of soil are placed back into the hole in layers and thoroughly tamped. Any standing water in the hole should be removed. Dry fill should be used and should not include any grasses, roots, pieces of wood, or other organic matter. It is important to stress that proper tamping is essential, as a poorly tamped pole will not stay in alignment. As a rule of thumb, if the tamping has been properly

done, little of the excavated soil should be left over. This ensures that a highly compacted volume of soil is located around the base of the pole.

In sandy or swampy ground, the pole should either be set deeper or supported by guys, braces, or cribbing. One form of cribbing uses an empty oil drum into which the pole is set. The drum is then filled with concrete or small stones to secure the pole. Another simple method of crib bracing is shown in Fig. 44.

In those few cases where greater stability may be required, concrete can be placed around the pole. In this case, the hole should be somewhat larger and the concrete should extend a little above ground level, with the surface beveled to encourage any rainwater to run away from the pole. Proportions for a good mix would be roughly 1:2.5:5 by volume (cement:sand:gravel) and this should be just fluid enough not to require tamping. To ensure proper setting, the pole should be well braced and not touched for up to a week after the pour.

If poles are subjected to slightly lateral forces as noted at the beginning of this section, pole keys can be used (Fig. 45). In hard soil, only the upper key may be needed; in soft soil, both keys would be used.

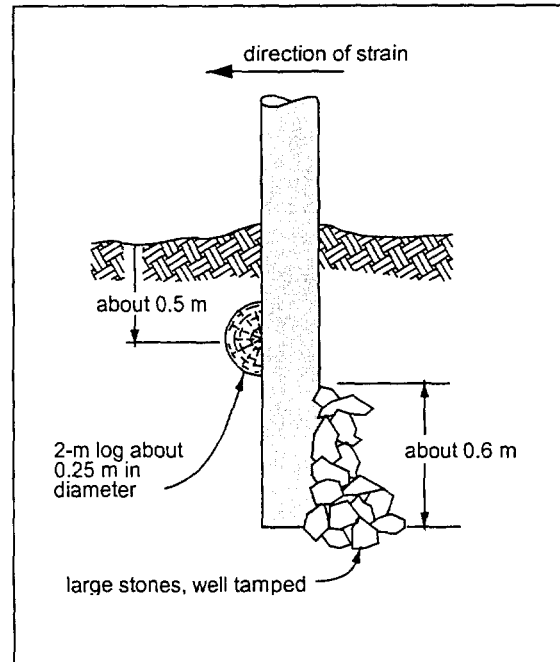


Fig. 44. An simple form of cribbing.

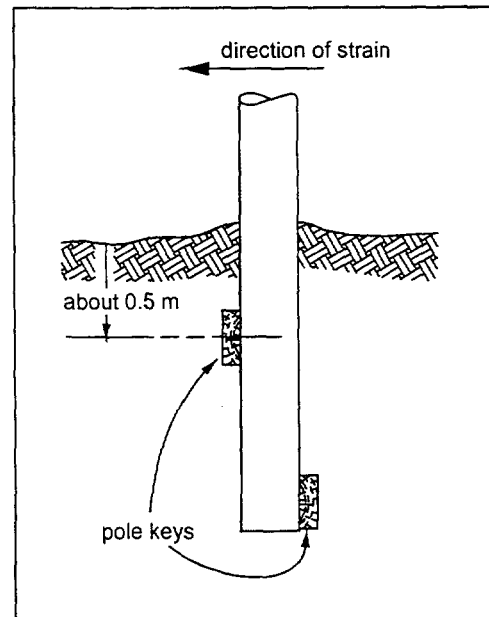


Fig. 45. An example of the use of pole keys to counteract small lateral forces acting on a pole.



## IX. Poletop hardware and connectors

---

Poles and conductors are typically the costliest elements for most mini-grids. However, miscellaneous hardware, while costing relatively little, plays a critical role in ensuring the integrity of the entire system. This includes the hardware necessary to ensure proper electrical continuity between the various conductors used in the system and the clamps or other hardware for securing the conductors to the poles or to other structures, such as to the homes being electrified. Poor use of this hardware can place the entire system in jeopardy. This chapter describes this various hardware as well as the proper procedures for using it.

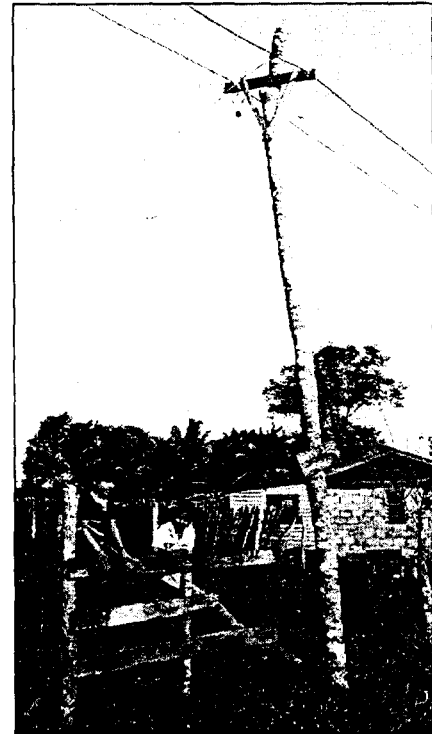
Before proceeding further, one component that can generally be eliminated from consideration is the crossarm, often seen as an intrinsic part of a power line. These are commonly used with medium-voltage lines to provide the necessary spacing between conductors to prevent clashing or shorting between conductors. While it is not rare to see crossarms being used for low-voltage mini-grids (Fig. 46), this is generally done more as a reflex action—power poles are simply expected to have crossarms.

With mini-grids, not only is a voltage of 120 V or 230 V rather than 11,000 V or 20,000 V much less dangerous, but insulated conductors are generally used. Furthermore, because crossarms associated with mini-grids are often poorly constructed, their inclusion merely decreases system reliability, as poorly designed crossarms and braces fail. Therefore, instead of using crossarms for low-voltage distribution systems, a vertical conductor configuration is typically used, with the conductors secured to the pole using spool insulators.

### Joining conductors: Connectors

Connectors are necessary to ensure a good electrical bond between the conductors being joined. These conductors are usually either of aluminum or copper. Before embarking on a discussion of connectors, it is necessary to briefly describe the characteristics of these two metals that affect the quality of connections made.

The surfaces of both copper and aluminum oxidize. This oxidized layer acts as an insulator and must be broken to achieve adequate metal-to-metal contact for a good electrical connection. Copper oxide is generally broken down by applying relatively low contact pressure. Unless copper is badly oxidized, good contact can be obtained with very little or no cleaning. However, aluminum oxide is a hard, tenacious, resistive film that forms rapidly on the surface of aluminum exposed to air. This is one reason for aluminum's good resistance to corrosion in a normal environment. The oxide film that forms after no more than a few hours is too thick and tough to permit a low resistance contact without cleaning. Even a bright and clean appearance of an aluminum connector is no assurance that low contact resistance can be obtained without cleaning.



**Fig. 46. Pole with crossarm for a distribution system in San Felipe, Belize.**

In addition to cleaning, the surface should be covered with a good connector compound to prevent the oxide from reforming. Common practice is to clear the surface with a wire brush or emery cloth. The compound should be applied immediately after cleaning. Some of these oxide-inhibiting compounds contain suspended metal particles to assist in penetrating thin oxide films and as an aid in gripping the conductor. They also seal out air and moisture, preventing further oxidation or corrosion.

If a connection has to be made between aluminum and copper conductors, bimetallic connectors designed for this purpose must be used. These provide adequate separation between the conductors to prevent electrolytic attack on the aluminum conductor. Even then, it is good practice to install the aluminum conductor above the copper conductor if possible. This will prevent pitting of the aluminum conductor due to copper salts being washed over the aluminum.

### **Twisted connections**

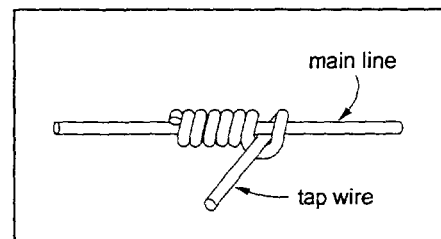
An all too commonly seen connection with all kinds of conductors, whether for low- or even medium-voltage lines, is the twisted connection, where the incoming conductor is simply wrapped around the existing conductor. This results in a poor, high resistance connection that can lead to voltage drop and power loss, especially when used along the main line which handles larger currents than the typical service drop. This resistance, and accompanying losses, can increase over time, as oxidation and corrosion of the conductor continue.

Because loads served by mini-grids are often smaller than those typically encountered on the national grid, smaller conductor is required. Smaller mechanical connectors for this conductor may simply not be available. Therefore, twisted connections may, at times, be the only option for small conductors.

However, this small conductor is frequently copper and the drawback associated with twisted connections can be resolved by soldering the connection. Twisted, soldered, and sealed connections are more of an art in today's world where quality electrical craftsmanship and apprenticeships are dying traditions. A single fashioned copper connection made by carefully wrapping two cleaned conductors and then applying solder to ensure the electrical bond may take up to 20 minutes. In today's fast-paced industrialized world that is too long. Nevertheless in remote rural settings, time and pride still abound and the "old ways" may still have a place in isolated electrification.

A twisted joint with copper conductors is made as follows. After the conductor has been mechanically secured to a spool insulator or equivalent, a portion of the insulation where the joint is to be made is stripped. The second conductor, that to be joined, is tightly wrapped around the first at this place and soldered (Fig. 47).

An electrical or thermal soldering iron can be used. If there is no electricity, an electrical soldering iron is of little use. In any case, soldering conductors larger than 10 mm<sup>2</sup> is almost impossible even with a 500-watt iron. What might be used is either a 0.5 kg thermal mass soldering iron or a plumber's kerosene blowtorch. The type of flux to be used is not as important as cleaning the conductors before soldering. Resin core solder is safer but does not clean the conductors as well as acid flux. But more care must be exercised with the latter. Eye protection and adequate clothing is recommended.



**Fig. 47. A variation on a simple twisted connection.**

Once completed, the joint and uninsulated portion of the conductor should be tightly wrapped with electrical tape to protect anyone who might be working in the vicinity of the connection as well as to protect against possible shorts.

### **Split-bolt connectors**

This split bolt was one of the earliest developed connectors specifically for making electrical connections between two conductors. Its design has changed little over the past century. The connector, as its name implies, is a split-shank bolt where the conductors to be connected are placed in the open groove of the connector (Fig. 48). Some split-bolt connectors will have a separating spacer that is intended to be placed between the connecting conductors. This spacer performs two primary functions:

- It provides more surface contact between the conductors.
- If tin-plated, it will serve as a bimetallic inert separator for dissimilar conductors such as aluminum and copper.

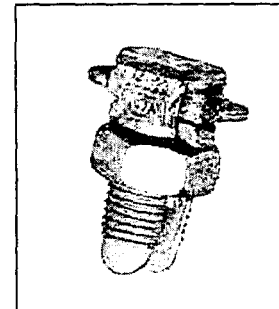
The advantages of this connector are that it is widely available in the local marketplace and may be installed with simple wrenches. Insulated split-bolt covers are available, but this type of connector is usually insulated using electrical tape. Problems associated with the split-bolt connectors are due to their misapplication or improper installation. Two wrenches or spanners are required when installing this connector, one to hold the head of the connector and the other to tighten the compression nut. Because this is a two-handed operation, the installer can find it uncomfortable to make a proper connection.

A word of caution: Although somewhat similar in appearance, U-bolt clamps should not be interchanged with split-bolt connectors because tightening a U-bolt can damage the conductor.

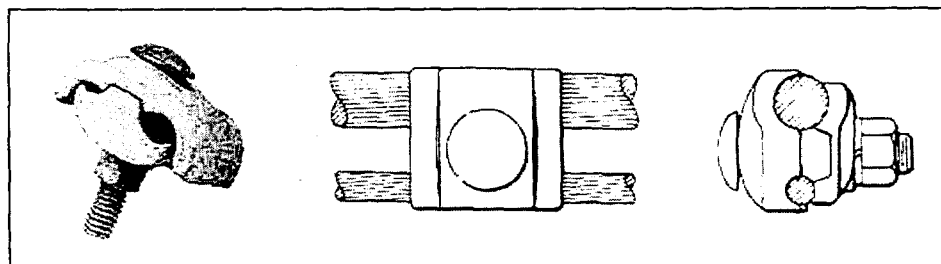
Split-bolt connectors are not available for conductors smaller than about 3 mm<sup>2</sup> or AWG #12.

### **Parallel-groove connectors**

Parallel-groove connectors may be used for all-aluminum and all-copper or for bimetallic connections (Fig. 49). They can be used to provide electrical continuity from one conductor to the next; they are not to be used to mechanically connect two conductors under opposing tension. Some parallel-groove connectors may be provided with square-neck carriage bolts which will allow single-wrench installation. However, with small conductors, a second wrench may be used to avoid kinking of the conductor when tightening the connector. The advantage of this connector is its simple installation; only a wrench is required. Problems associated with this connector are also due to misapplication or improper installation



**Fig. 48. A split-bolt connector, with spacer.** (Source: Burndy Corp., Manchester, New Hampshire)



**Fig. 49. Parallel-groove connector.** (Source: Burndy Corp., Manchester, New Hampshire)

of the connector. It is also difficult to insulate this type of connector due to its size and the exposed bolt threads. For small conductor, this type of connector is more expensive than other types that cover the same range of conductor sizes.

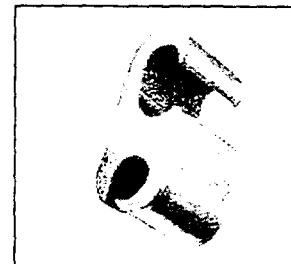
This type of connector is typically available for conductor no smaller than about 8 mm<sup>2</sup> (AWG #8).

### **Compression connectors**

Compression connectors provide excellent electric and mechanical connecting properties. The compression connector, with its wide range of applications, has become the most widely used and least problematic connector available in the market today. Compression tap connectors can accept a wide range of conductor sizes and can accommodate copper, aluminum, and ACSR (Fig. 50).

This type of connector requires a special compression tool, which frequently uses custom dies that are placed in the jaw of the tool and match the compression connector being used. However, some standardized dies can cover a range of conductor sizes. A drawback associated with using this type of connector is that nothing can be done without the proper tool and proper die. If this tool has been misplaced or damaged, then the use of generic tools like pliers or vise grips might be attempted. But these will normally result in an improper connection. Another drawback to these connectors is that they can only be used once; they cannot be opened and reused elsewhere.

These connectors are typically available to handle conductor beginning at about 3 mm<sup>2</sup> (AWG #12). The connector shown in Fig. 50 can handle a range of conductor sizes. Before the connector is crimped, the upper portion is hung over the main conductor and the end of the smaller service drop is passed through the opening at the bottom.

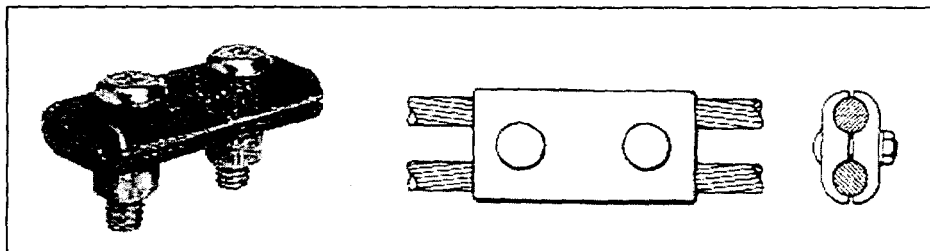


**Fig. 50. A compression connector to connect a larger distribution line to a smaller service drop. (Source: Burndy Corp., Manchester, New Hampshire)**

## **Securing the conductors: Deadend hardware**

### **Parallel-groove clamps**

The parallel-groove clamp can appear similar to the parallel-groove connector described previously but is more robust and usually has more bolts to clamp down on the conductor (Fig. 51). Designs are available that can be used to clamp either bare or insulated conductor. These operate by crushing somewhat the cable and slightly deforming it. As a deadend clamp, the conductor is passed around an insulator and the tail is folded back on itself and clamped. The same procedure is also commonly used for deadending guy wires. As with all bolted hardware, if the bolts and nuts are not tightened according to the manufacturer's



**Fig. 51. Parallel-groove clamp. (Source: Burndy Corp., Manchester, New Hampshire)**



specifications, the deadend may fail. Another drawback is cost, and as a deadending solution, parallel-groove clamps are not the most cost-effective solution.

A parallel-groove clamp can also be used to secure a pair of insulated conductors to a wire loop (a bail) that is in turn hooked to the pole or other support as is shown in Fig. 52. The clamp used in this figure was fabricated locally in Nepal. But a common problem was that, because considerable force is required to tighten the clamp, it would eventually cut into the insulated conductors and create a short.

### **Preformed deadends**

The most popular and cost-effective deadending hardware for the common sizes of conductor used by electric utilities (#6 to 4/0 or from 13 to 110 mm<sup>2</sup>) is the preformed deadend (Fig. 53). The preformed deadend requires no special tools and, for small conductors, no tool whatsoever for installation. The preformed deadend is

inserted around the insulator or deadend clevis and then wrapped around the conductor (which can be either insulated or bare). The few drawbacks to this deadending device are that the preformed grip must be specifically matched to the conductor size and its reuse is

not recommended. However, in the real world, this is of little concern, because deadends are rarely replaced.

### **Automatic deadends**

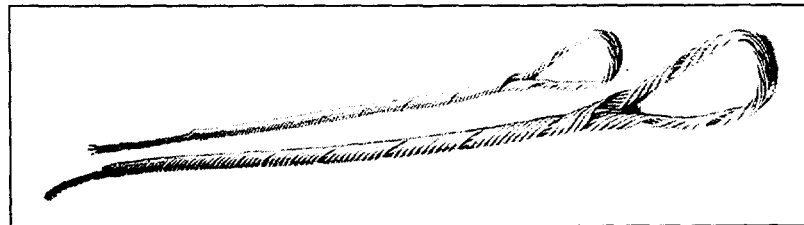
Automatic deadends are available for copper, aluminum, and ACSR conductors. A machined jaw inside of a tapered cylinder adjusts and holds the conductor in place (Fig. 54). This type of deadend is the easiest of all deadends to install and some manufacturers will allow the deadend to be reused. The main drawback is the cost. For small conductor sizes, the automatic deadend solution may not be the most economical option. This deadend is available for conductors beginning at 8 mm<sup>2</sup> (AWG #8).

### **U-bolt-type clamps**

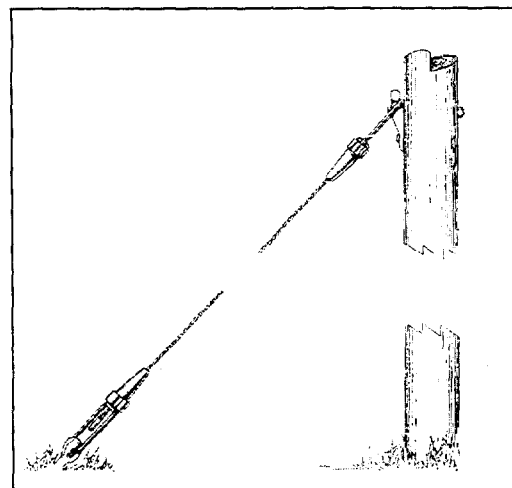
Specialty clamps which utilize a U-bolt along with a cap and a spacer to confine the conductor are available



**Fig. 52. A living tree is used as a pole and the two-conductor ABC is deadended on both sides of the tree.**

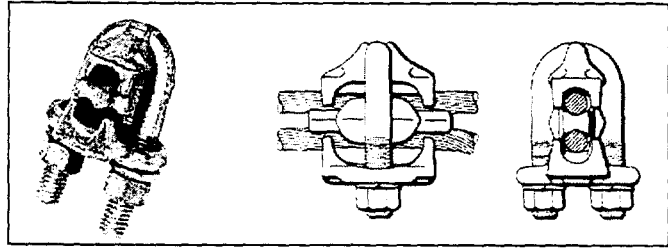


**Fig. 53. Preformed deadends installed over the end of a length of conductor. (Source: Preformed Line Products, Cleveland, Ohio)**



**Fig. 54. An automatic deadend can be used at each end of a guy wire.**

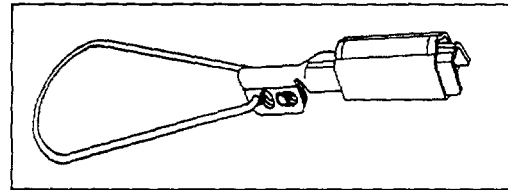
(Fig. 55). These should not be confused with standard U-bolts that are commonly available. These latter are to be used only with steel cable. If a U-bolt is tightened on copper or aluminum, it will compress into the softer metal, damage the conductor, and possibly cause premature failure.



**Fig. 55. U-bolt-type clamp.** (Source: Burndy Corp., Manchester, New Hampshire)

### **Wedge clamps**

Wedge clamps can be used for deadending self-supporting service drop wire. A wedge clamp commercially available for this purpose is shown in Fig. 56. In its operation, the conductor is slipped between the wedge and the sleeve (Fig. 57). Placing the conductor under tension forces the wedge into the sleeve, compressing the conductor against the sleeve. The clamping force increases as tension on the conductor is increased.



**Fig. 56. Wedge clamp.** (Source: Thomas & Betts, Memphis, Tennessee)

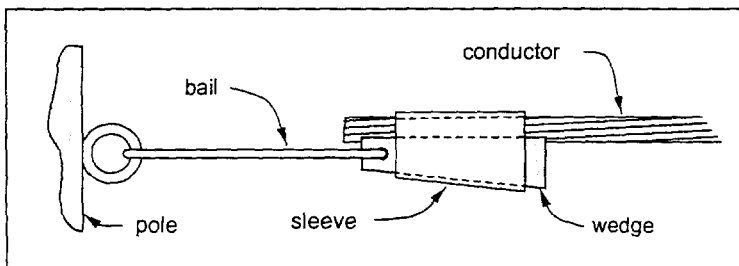
The wedge clamp grips both ACSR and aluminum conductor and is available with a rigid or flexible bail (the loops at the end of the clamp from which it is supported). Single clamps may accommodate a range of conductor sizes. The wedge clamp has a large surface area that grips the conductor with or without insulation and minimizes crushing damage to the conductor and/or insulation. An advantage is that no special tools are required for installation and the wedge clamp may be reused.

This clamp is not readily available in most local markets and is a more expensive type of deadending device. Sizes are available for conductors beginning at 13 mm<sup>2</sup> (AWG #6).

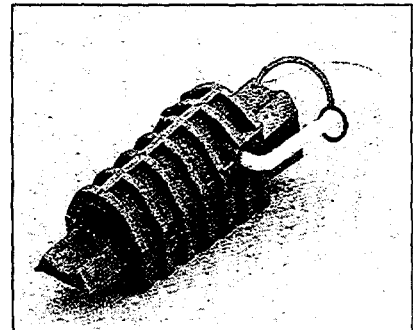
Wedge clamps are also available for deadending insulated conductor such as ABC (Fig. 58).

### **Supporting the conductor**

Racks, upset bolts, and clevises are used to support spool insulators that are in turn used to support conductors on the pole. For all these options, the conductor should be tied to the spool as shown in Fig. 59. If there is a deviation in the direction of the line at the pole, the conductor should be placed on the side of the spool insulator so that the conductor pushes against it (the first two illustrations in Fig. 60). If the angle of deviation of the line is greater than 60°, then the conductor should be deadended in each line direction (Fig. 60, last illustration); otherwise,



**Fig. 57. Basic configuration of a wedge clamp.**



**Fig. 58. This wedge clamp for insulated ABC conductor is fabricated of plastic.**

excessive force is placed on the rack or clevis support.

### Racks

For multiple-wire low-voltage installations, spool insulators are typically fitted to racks that are fastened to the pole with two or more machine bolts (Fig. 61). The racks can be fitted with multiple insulators at fixed spacings, thus providing flexibility in different configurations of low voltage-lines. The advantage is

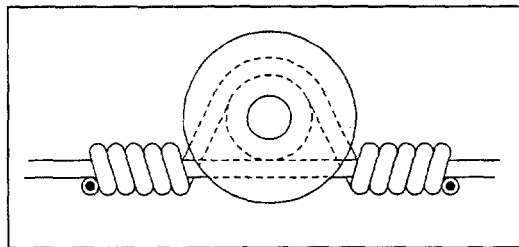
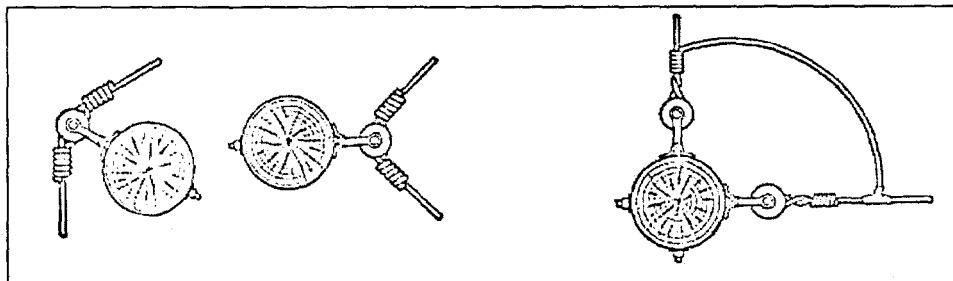


Fig. 59. Tying a conductor to a spool insulator

Fig. 60. Proper placement of the conductor on a spool insulator.



that a single standardized rack can accommodate almost all the open low-voltage applications, thereby simplifying warehousing and purchasing. This approach can also lead to the main disadvantages of the racks. The full use of the multiple spools may not be necessary and the rack becomes an expensive piece of hardware where a single upset bolt or support clevis would suffice. There is also a tendency to overstress the rack when it is used in deadend applications with larger conductor (i.e., because of the greater tension involved). The bolt pattern of the rack may not conform to the deadend spacing of the conductors and the rack will bend and eventually fail. Another disadvantage is that if a bare conductor is not correctly tied to the vertically installed spool insulator, it can move down onto the metallic support and cause a short to ground.

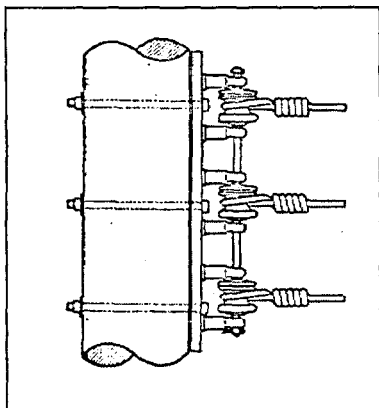


Fig. 61. Spool insulators mounted on a secondary rack and used here to deadend a line. In this case, the bolt pattern coincides with the spool positions.

### Upset bolts

Single and double upset bolts are used for single conductor installation (Fig. 62). The upset bolt is a modified machine bolt with an extension for installing a single spool insulator. The single

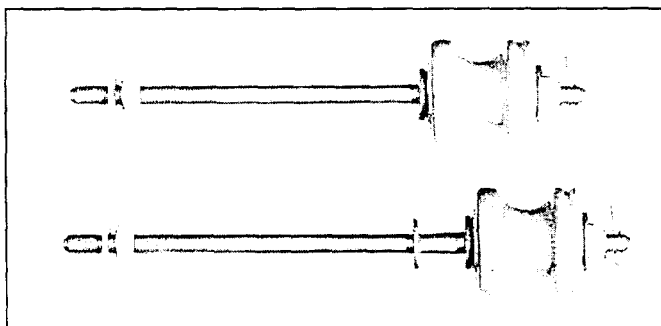


Fig. 62. Spool bolts (single- and double-upset).  
(Source: Joslyn Manufacturing Co., Franklin Park, Illinois)

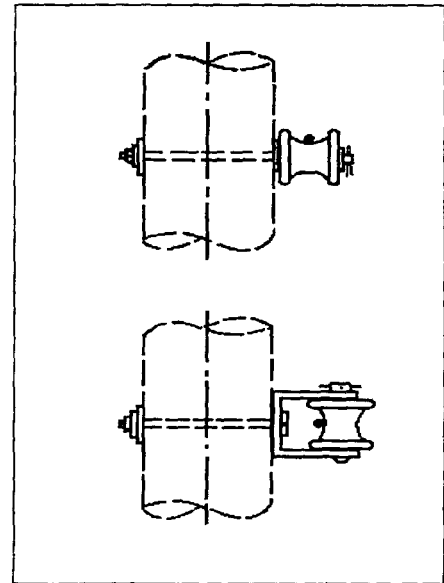
upset bolt is for mounting the neutral and the spool is mounted next to the pole. The double upset bolt is used for energized conductors and provides spacing between the pole and the spool insulator. The upset bolts are used in tangent applications (i.e., no lateral angular change in the direction of the conductor as it passes the pole) and for angles up to 5° (Fig. 63). The advantage of the upset bolt is that it is an inexpensive support for a spool insulator and spacing between conductors is not fixed as with the fixed spacing of the rack.

### **Support clevises**

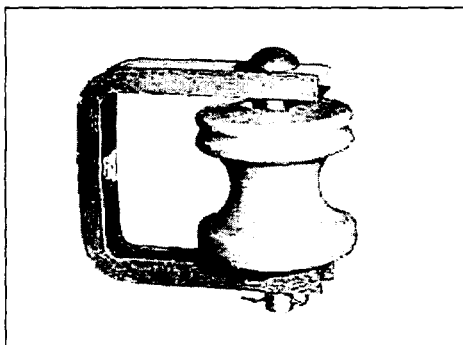
Support clevises are fixed, single-insulator supports that are fastened directly to the pole with a machine bolt. These look like single-spool insulator racks (Fig. 64). The advantage of a support clevis is that a single hardware item can be used for all applications. However, a support clevis with a machine bolt is costlier than an upset bolt. Also, an improperly tied bare conductor can drop down onto the metal support can and cause a short to ground, depending on the type of pole. Clevis supports are used for line angles from 5° to 30°.

### **Swinging clevises**

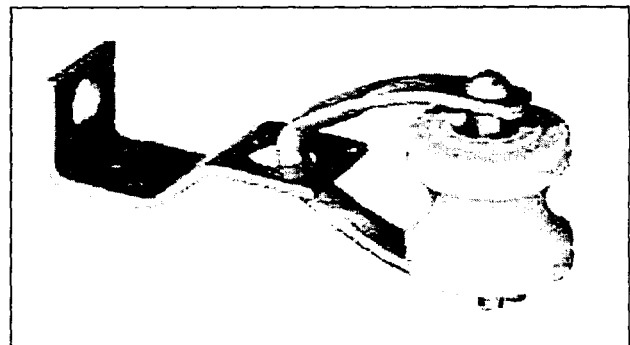
Spool-insulator swinging clevises (Fig. 65) are used to provide a flexible swinging support for the conductor. Swinging clevises are used in deadending applications and angles from 30° to 60° where a certain amount of freedom of movement is desired for attaching the conductor to the pole. This freedom of movement is desirable at angle structures and deadends to absorb mechanical stresses caused by wind and span length variations. The advantage to the swinging clevis is that it provides a shock absorbing point for the conductor and provides a greater distance between the pole and the conductor. The disadvantage is that this unit is relatively expensive compared to the fixed clevis support and requires an increased inventory of hardware.



**Fig. 63. Comparison of the installation of a single upset bolt and a clevis. The former is only used for angles less than about 5°.**



**Fig. 64. Support clevis.** (Source: Joslyn Manufacturing Co., Franklin Park, Illinois)



**Fig. 65. Swinging clevis.** (Source: Joslyn Manufacturing Co., Franklin Park, Illinois)

## Wireholders

A wireholder is a porcelain insulator fitted with a heavy wood screw or clamping device in order to secure it to a wooden beam or pipe conduit, respectively (Fig. 66). Wireholders are designed for service drop (Fig. 67) applications but have found use in small conductor applications for main lines. The advantages are ease of installation and low cost. Their disadvantage is their relatively low mechanical strength to support the conductor. Over time, the wireholder may loosen and fall from the pole as the pole deteriorates.

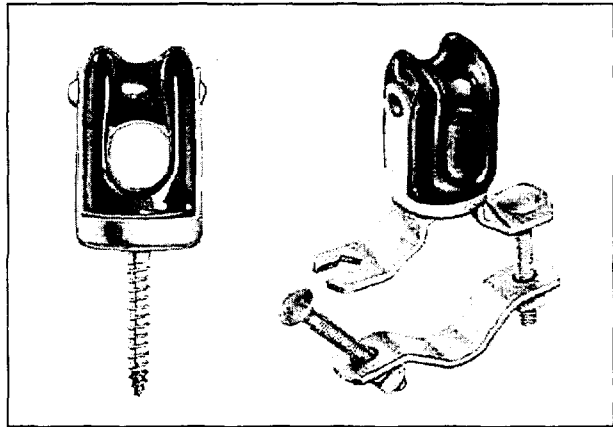


Fig. 66. Wireholders. (Source: Joslyn Manufacturing Co., Franklin Park, Illinois)

## Other approaches

Other approaches have been adopted to support conductor. One such approach is the use of suspension clamps that are available to support bare or insulated conductor (Fig. 68). Locally-made J-shaped clamps have also been used. However, in this case, care must be taken when used to support insulated conductor or bare aluminum conductor because, over time, the support can pierce the insulation or cut into the conductor. Commercially, clamps are available which are coated with heat- and UV-resistant plastic. Nepal fabricated its own clamps with a flexible insert to protect the insulation (Fig. 69).

Other less conventional approaches to supporting conductor are found in low-cost schemes that use insulated conductor (Fig. 70). This can be either multiple lengths of single-core insulated conductor or non-metallic sheathed multi-conductor. In these cases, the conductor is either looped once around the pole (Fig. 71) and held in place with a staple or is supported by a loop of insulated wire also held in place

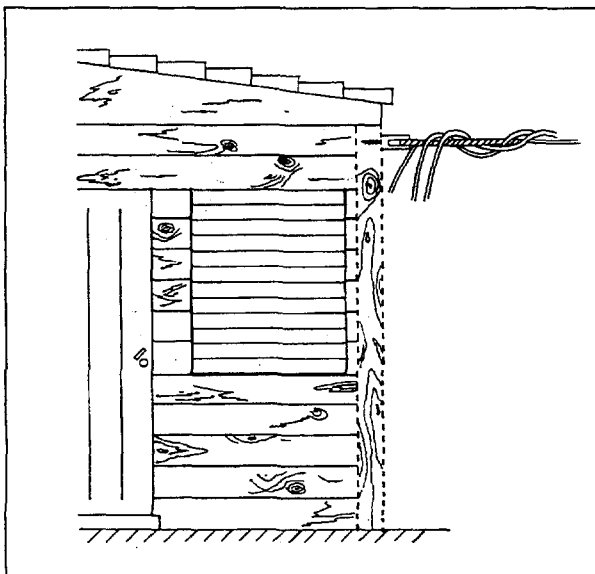


Fig. 67. A wireholder used to deadend a service drop must be secured to a solid part of the home.

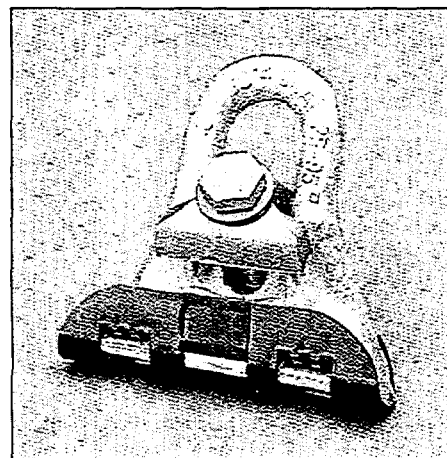


Fig. 68. A commercially made suspension clamp for bare messenger conductor. To support insulated conductor, the same clamp is available with a plastic coating.

to prevent its slipping down the pole. While all these approaches can initially work, a major concern is how long it will be before the conductor breaks or the insulation wears through from rubbing due to movement of the conductor and due to the concentration of force over a small area. This can then cause a potential threat to the safety of people in the vicinity and requires further repair which might be even more makeshift and dangerous. Therefore, while this results in an initially cheaper system, it will result in a system that is less reliable and less safe and, over the long term, possibly costlier.

### Lengthening conductor: splices

When long lengths of conductor are required, it may be necessary to splice or join two pieces end to end. Splicing should serve two purposes: to maintain electrical conductivity and to maintain the physical strength of the conductor through the splice.

Where the conductor is small and relatively inexpensive, it may be advisable to avoid splices altogether. In the case of a distribution line, this would be done by simply deadending the conductor to the pole nearest its end and cutting off the remainder, except for a short tail. The next length of conductor used to continue the line would also be deadended at that pole. A connector (p. 104) would then be used to join together the two loose tails, providing the electrical continuity.

For copper and steel conductor, splices can be made by properly twisting the conductors together and soldering. But special hardware is typically used for this purpose. Four basic types of acceptable splices are described below. Parallel clamps should not be used to splice two conductor together under tension because this can damage the conductor. However, parallel connectors can be used when the

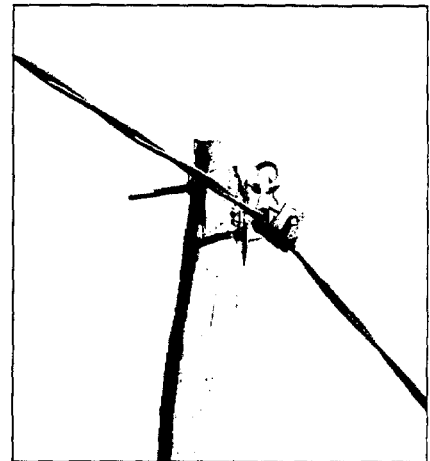


Fig. 69. A locally-fabricated J-hook with a flexible insert to support insulated ABC in Nepal.

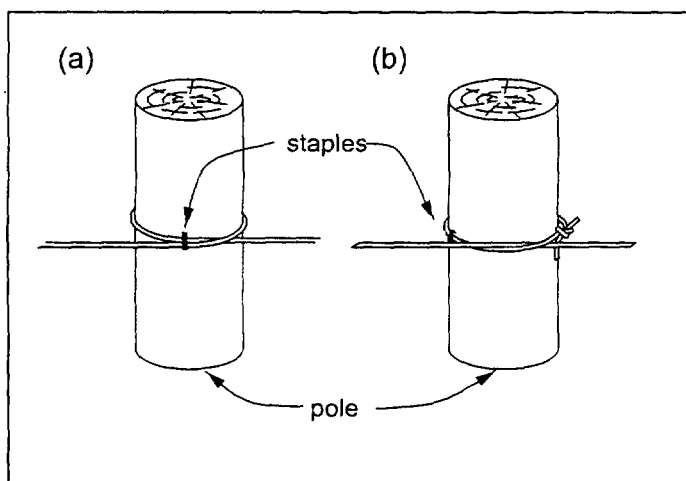


Fig. 70. Several rudimentary approaches for fixing an insulated conductor to a pole.

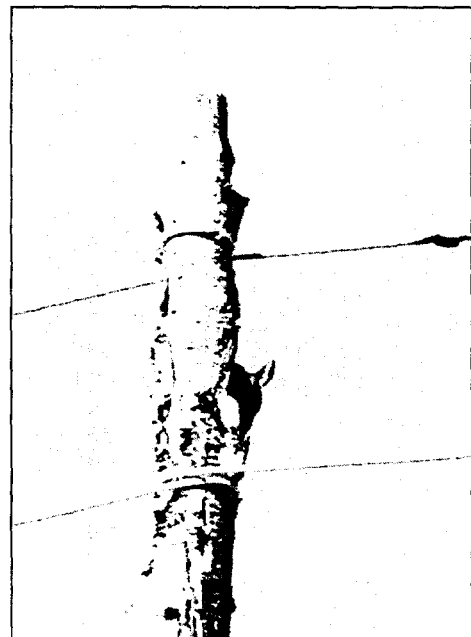
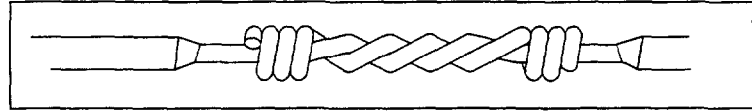


Fig. 71. Insulated copper line secured to a distribution pole by wrapping once. Stapling the conductor prevents movement down the pole.

conductors are not under tension, such as between the loose ends of two deadended conductors on the same pole.

### **Wrapped/twisted splices.**

This splice is used on small solid conductors made of copper or steel. The two wires are laid parallel and one conductor is wrapped over the other in reverse turns. Such a splice is shown in Fig. 72. To improve the conductivity and strength the splice



**Fig. 72. A twisted splice before soldering.**

is soldered. This type of splice requires discipline and an appreciation for quality workmanship if it is to be used successfully.

Twisted splices should not be used with ACSR, AAAC, and other aluminum multiple-wire conductor because these do not provide any mechanical strength and would introduce line loss due to poor conductivity across the splice.

### **Compression splice**

This type of splice is very reliable and now commonplace. For small size conductors, the cost of this splice is very attractive. A compressible splice is a metal tube that slides over the ends of the conductors to be spliced and is squeezed or crimped onto the conductor by a compression tool. The compression sleeve should only be used for the size of conductor for which it has been specified. Furthermore, the compression tool must be fitted with the dies for that particular sleeve. If properly installed, the sleeve should be able to support the full tension of the conductor. A disadvantage of this splice is that it cannot or should not be made without the proper compression tool and die.

For multi-layered ACSR transmission conductors, a couple of sleeves are installed over each other. The inner steel sleeve is used to secure the two ends of the steel core and the outer sleeve is used over the outer aluminum strands and the inner sleeve. However, for the ACSR commonly used for distribution line, this type of splice is increasingly being replaced by a single sleeve placed over the entire conductor. Sizes range from solid #8 AWG (8 mm<sup>2</sup>) copper conductor and #4 AWG (21 mm<sup>2</sup>) ACSR on up.

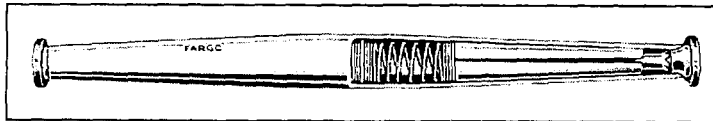
For small solid-core conductors, a compression splice would be the best recommendation. This splice will offer both good mechanical strength and optimum electrical conductive properties. Hand operated mechanical presses are reasonably priced and can provide years of service if cleaned and maintained periodically.

### **Preformed splice**

This splice is made up of preformed tempered wire that is installed by hand over the conductor as in the case of preformed deadends. The splice principal is based on the "Chinese finger puzzle". As tension is applied to the splice the covered preformed wires will grip the spliced conductor firmer. As in the case of preformed deadends, preformed splices should not be reused. These types of splices do not require special tools like the press for the compression splices. Splices for small sizes are not readily available below #6 AWG and the splices may not accept full tension.

### ***Automatic splice***

This splice is based on gripping wedges inside of a tapered tube (Fig. 73). The bared end of each conductor to be spliced is inserted into the tube with the gripping jaws. When the ends are fully inserted and then placed under tension, the gripping wedges are pulled toward



**Fig. 73. An exploded view of an automatic splice.** (Source: Fargo Mfg. Co., Poughkeepsie, NY.)

each end, further tightening their grip on the conductor. The advantage of this splice is that its application requires no special tools. It is the easiest and most trouble-free method of splicing conductor. On the other hand, this type of splice is usually the most expensive of all the mechanical splices available, although prices have been going down as they have gained in popularity. These splices cannot be reused. Automatics splices are commonly available for solid copper conductor down to AWG #8 (8 mm<sup>2</sup>) and for ACSR down to AWG #4 (21 mm<sup>2</sup>).

### ***Knotting***

An unconventional but fairly common practice for some low-cost schemes that use smaller insulated conductor is to join the conductors by knotting together their ends. In this manner, it is the knot that provides the strength in tension. The insulation on the free ends of the knot is partially removed and the ends should then be connected using one of the techniques described earlier (p. 104). This is not a conventionally accepted splice and it is not clear how durable it is, what type of knot least compromises on the strength of the line, etc.



## X. Guys and anchors

When a line deadends on a pole or when there is a deviation in the direction of the conductor at a pole, it places a permanent force on the pole. If significant, this force must be counteracted by a guy wire that transfers the force to an anchor in the ground. Guy wires are usually made of stranded steel that is heavily galvanized. However, where guys are near chemical plants or in mining districts, galvanized wire will not stand up, and copper-clad cable may be used under such conditions.

While guy wires are commonly used with conventional medium- and low-voltage lines, mini-grids may use considerably smaller conductor. When this is the case, these smaller conductors can be placed under less tension, and forces which are in turn transferred to the poles at bends or at dead ends are correspondingly smaller and may not require guys to counteract. Furthermore, if ground clearance is more than adequate, lines can have considerable sag, further reducing the tension (see sag-tension relationship, p. 80).

In some countries, guy wire can be useful and tends to “disappear”, placing the system at risk. Therefore, if a guy is essential to ensure the proper operation of the system, all member of the community must be aware of this to avoid tampering or theft. The guy must also be protected vehicles and pedestrians from accidentally running across it.

### Strength of cable

#### *Guy on a deadend pole*

Fig. 74 illustrates two cases in which guys are used. In the case of a simple deadend at the end of a line (a), the tension in each of the conductors exerts an unbalanced force on the pole.  $H$  represents the sum of the horizontal forces on the pole due to the tensions in the two or more conductors. In most cases, this is approximately the same as the sum of the tensions in the conductor. A guy is required to counterbalance this force. However, because the guy is anchored in the ground and makes an angle  $\theta$  to the horizontal, the tension in the guy is greater than  $H$ . It is also increased by a factor  $SF$ , a safety factor of perhaps 2. With a total force of  $H$  imposed by all the conductors, the guy must be able to resist the force  $T_g$  of the following value:

$$T_g = \frac{H \cdot SF}{\cos \theta}$$

The tension in each conductor can be obtained once the sag and weight of that conductor has been established (p. 79).

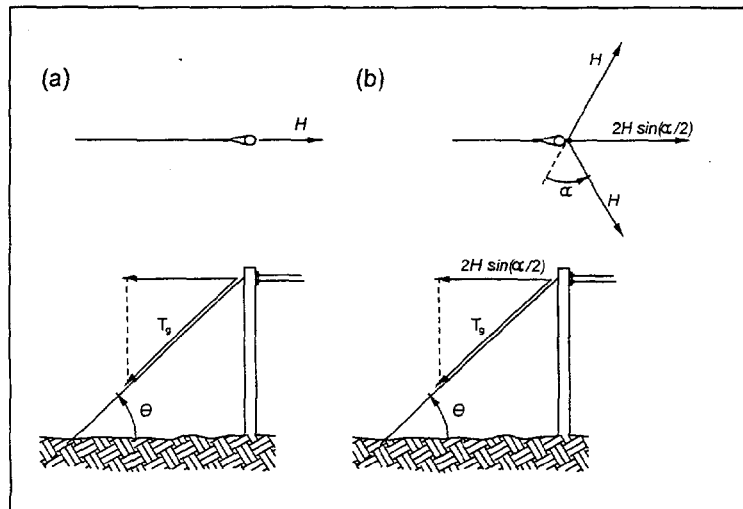


Fig. 74. Calculating guy tensions (a) at a deadend structure and (b) at a deviation along a line.

### Guy at a deviation

If there is a deviation in the line equal to an angle of  $\alpha$ , the conductors exert an unbalanced force in the direction that bisects the angles between the two conductors of a value shown in Fig. 74. Here,  $H$  is the sum of the horizontal forces of all the conductors in any one direction and is again approximately equal to the sum of the tensions in all the conductors in that direction. All the forces originating with the conductors must again be resisted by the guy, resulting in a tension in the guy of the following value:

$$T_g = \frac{2 H \cdot SF \cdot \sin\left(\frac{\alpha}{2}\right)}{\cos\theta}$$

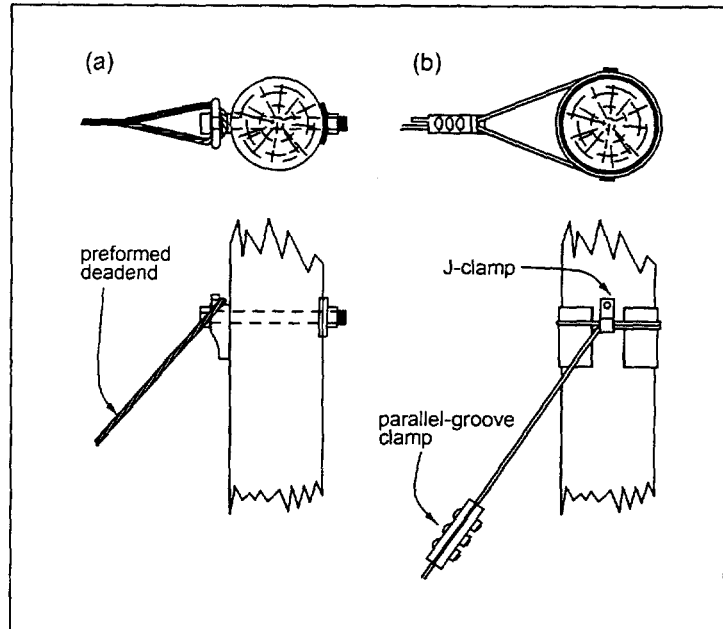


Fig. 75. Options for securing a guy wire to a pole.

### Securing the guy to a pole

Fig. 75 illustrates two conventional ways of securing a guy wire to a pole. The first (a) requires a guy hook of any one of numerous designs (Fig. 76) mounted with a through bolt. With a wrapped type design (b), the guy wire encircles the pole over curved sheet metal plates to prevent the guy from biting into the grain of the wood. A J-clamp (Fig. 77) on each side of the pole prevents the guy wire from traveling down the pole. The guy wire is deadended by using either preformed deadends (p. 108), parallel groove clamps (p. 107), automatic deadends (p. 108) or U-bolts (Fig. 78).

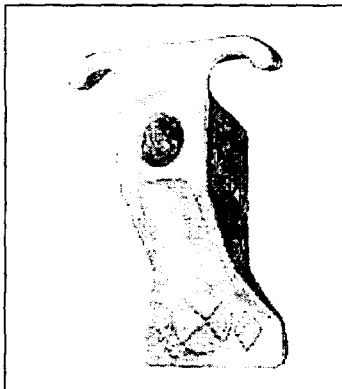


Fig. 76. Guy hook attachment. (Source: Joslyn Manufacturing Co., Franklin Park, Illinois)

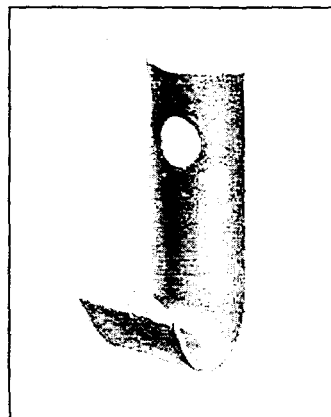


Fig. 77. J-hook. (Source: Joslyn Manufacturing Co., Franklin Park, Illinois)

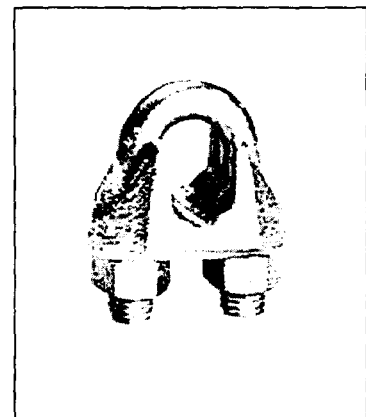


Fig. 78. U-bolt clamp. (Source: Joslyn Manufacturing Co., Franklin Park, Illinois)

## Types of anchor

Several approaches to anchoring can be applied in less accessible areas. The least expensive anchor is probably the deadman anchor. It has the advantage that its holding power can surpass that of other types of anchors because this can be changed by changing its size, in addition to its depth. Anchors of this type are commonly made of a section of a log. Even untreated logs can last a long time if adequately buried. At times, sections of concrete that have broken in transport have been used as anchors. This type of anchor is installed as shown in Fig. 79. The anchor rod is laid in an area which has been trenched out. As with all buried anchors, it is preferable to tie into them using threaded anchor rods that connects to the guy wire above ground because they are less susceptible to corrosion damage. A hole should be drilled through the log and a washer of adequate size used under the nut. As a less costly although possibly less durable alternative to using an anchor rod, the guy wire is sometimes painted with bitumen, placed around the anchor, and tied together with a guy (parallel groove) clamp.

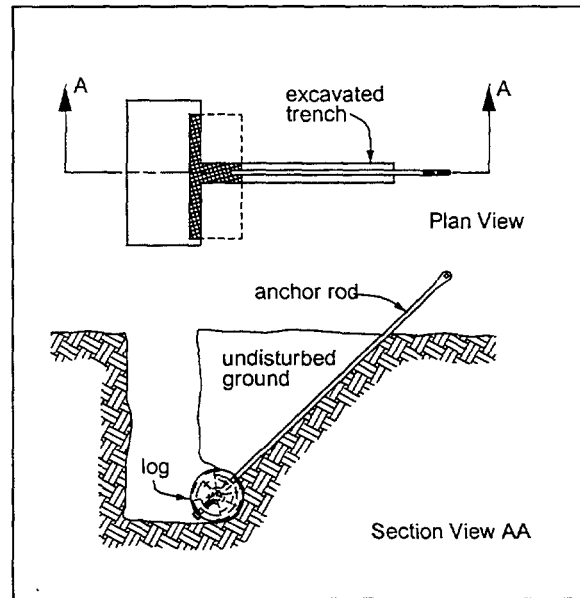


Fig. 79. Installation of a deadman anchor.

A second type of anchor is the plate anchor. Its installation is illustrated in Fig. 80. Because this anchor bears completely against undisturbed earth, it develops a large holding power in most soil. Where the cost of labor is high, the disadvantage with both of these types of anchors is that considerable labor could be required to dig a hole of adequate size and depth. In areas with vehicular access, this can sometimes be avoided through the use of screw anchors that are screwed into the ground. Power equipment is generally used for this purpose because considerable torque is required.

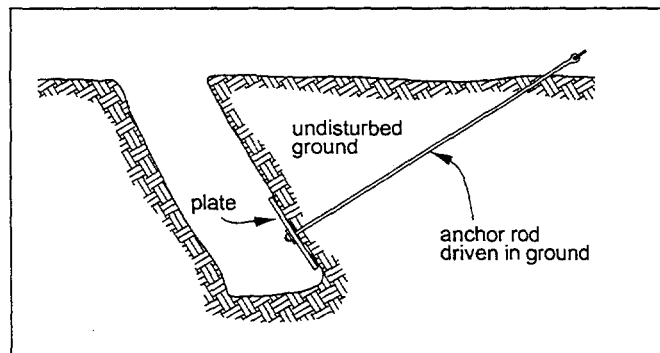


Fig. 80. Installation of a plate anchor.

Each of these anchors should be installed so that it rests beneath undisturbed earth as much as possible. The entire length of the anchor rod and the guy cable should be set in a straight line between the attachment on the pole and the point where the rod attaches to the anchor. If the rod is out of alignment, it will eventually pull into alignment, causing a lengthening of the guy-anchor assembly and permitting the pole to lean in the opposite direction.

A third alternative is an anchor rod cast into a circular block of concrete (Fig. 81). But this type of anchor most effectively works with a mechanized pole auger slightly larger than the diameter of the concrete block.

In solid rock, a rock anchor (Fig. 82) can be used. A hole the size of the anchor (and not larger) must be drilled in the rock. Once inserted, this anchor stays in place by driving it over a wedge that opens the end of the anchor, wedging it in place. A variety of rock anchors are available.

### Sizing an anchor

Without extensive and costly soil tests, it is difficult to precisely determine the required size and depth of an anchor. It is more economical to oversize these. To size an anchor, it can be conservatively assumed that the anchor is held in the ground solely by the weight  $W$  of the soil directly above it (Fig. 83). And for an anchor to function properly, this weight must be at least equal to the component of the force in the guy wire pulling vertically.

$$T_g \cdot \sin \theta = W = w \cdot A \cdot D$$

In this equation,  $A$  represents the area of the anchor ( $m^2$ ) as seen from above. An average value for the unit weight of soil ( $w$ ) is  $1,300 \text{ kg/m}^3$  or  $13 \text{ kN/m}^3$ . This is a value for undisturbed soil, which should be the case if the anchor has been properly installed (as described earlier). To calculate the minimum depth at which the anchor must be buried, the above equation is solved for  $D$ :

$$D = \frac{T_g \cdot \sin \theta}{w \cdot A}$$

From an earlier equation, it can be seen that the value of  $T_g$ , already includes a safety factor  $SF$ . The value of  $D$  can be altered somewhat if it is felt that a modification of the safety factor is required.

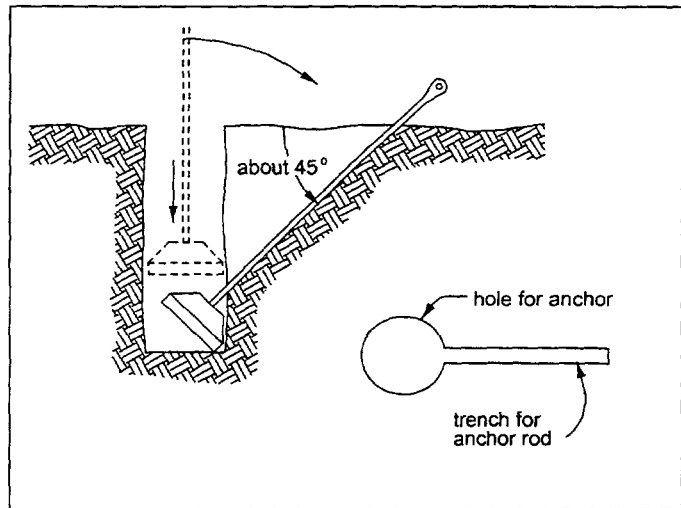


Fig. 81. Concrete block anchor.

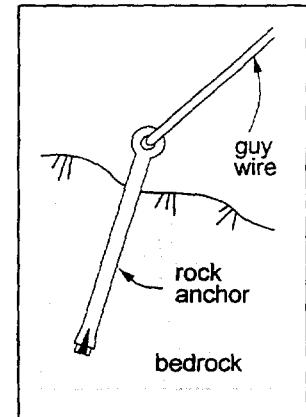


Fig. 82. Installation of a rock anchor.

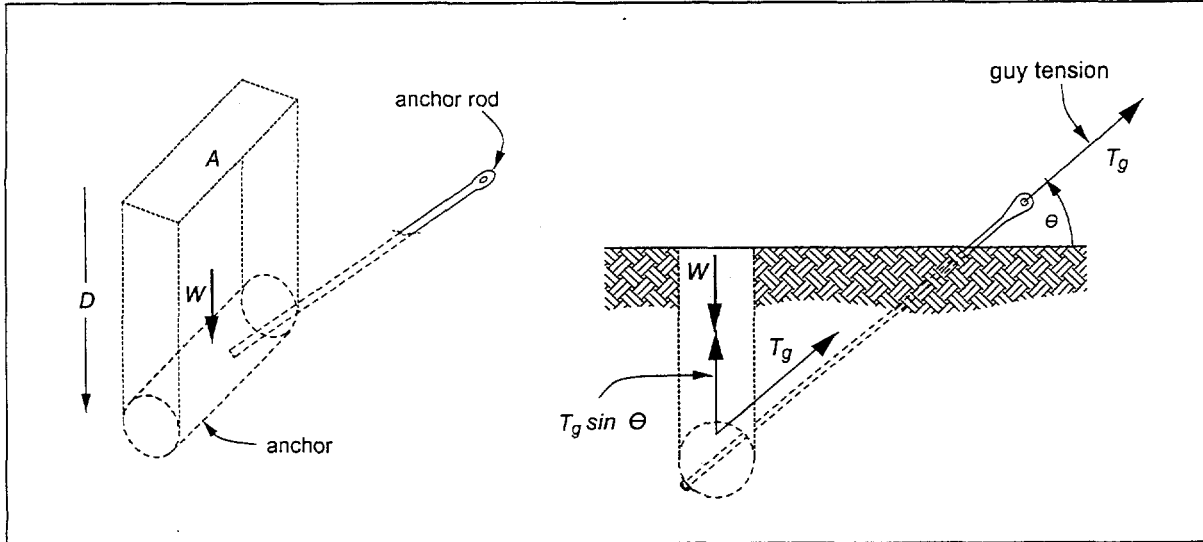


Fig. 83. An anchor is assumed to be restrained by the weight of the soil above it.



## **XI. Safety and protection**

---

### **Introduction**

This chapter is concerned with the reliability and the safety of the distribution and housewiring systems. One concern is to ensure protection of appliances and end-use equipment. These can be damaged by incorrect installation and poor-quality electricity supply. These factors in turn can lead to safety risks as well as to needless expenses. This concern extends to the protection of distribution cables, housewiring, and devices from degradation and damage; otherwise, these present similar risks.

Risks to appliances and equipment that should be protected against can be caused by the following:

- Incorrectly installed or sized components causing internal heating (such as poor electrical connections, undersized conductor, or motors that are not properly matched to the speed of the load they are driving)
- Excessive currents, caused either by overloading the circuit or by contact between two or more conductors (generating heat and/or sparks which could lead to fire)
- Undervoltage and overvoltage (which can prevent motors from properly starting, in turn leading to excessive currents; prematurely age fluorescent lamps and ballasts; or burn out light bulbs)
- Underfrequency and overfrequency (both factors which can cause some appliances to run hotter)
- Mechanical stress (for instance, dropping a heavy or sharp object on a cable, a tight bend forced on an inflexible cable, or a conductor connection failing due to fatigue caused by repetitious flexing)
- Temperature stress (external overheating caused by, for example, placing a cable too close to a fire, cookstove, or lamp)
- Chemical stress (such as corrosion caused by joining of two dissimilar metals such as aluminum and copper or the degradation of insulation material causing embrittlement and cracking)
- Lightning
- Ingress of dust and liquids (such as rains and condensation)

Another closely related concern is human safety. Electricity can be dangerous, particularly for villagers to whom it is largely unfamiliar. Every effort should be made to minimize the risk to those using electricity. In addition to threats to safety caused by the factors mentioned above, other risks to humans include the following:

- Shocks due to direct contact with live conductors.
- Shocks due to indirect contact with live conductors, by touching liquids or exposed metallic parts which have inadvertently become electrically live (or by touching other people who are inadvertently live)
- Fires started by sparking or overheating of damaged or degraded or wrongly installed electrical components
- Shocks due to lightning conducted to exposed parts or liquids.

The need to ensure a safe and reliable system should be a concern at each step of the project as it progresses, from design stage through to construction. This concern for safety should continue through to the operation and maintenance of the system. Each time any action has to be taken—whether repairing a fallen conductor, extending the distribution system, or adding outlets in a home—the normal reflex action should be to ponder the safety implications of each design or procedure being considered.

In designing and constructing a mini-grid, the objective should be to strive to address all these potential risks. This can be done through a variety of actions:

- Incorporating and correctly installing the following:
  - Overcurrent circuit devices
  - Residual-current devices (ground-fault circuit interrupters)
  - Grounding electrodes
  - Lightning arresters
  - Voltage and frequency limiters (these are considered as part of the design of the electricity supply rather than of the distribution system and not considered herein)
- Properly maintaining the installation
- Periodically testing installed safety devices and replacing them as necessary
- Taking precautions against mechanical, thermal, and chemical stress
- Consumer and operator education

Because the concept of grounding (or earthing) of an electrical system is commonly referred to in discussions about protection and safety, this chapter will begin by reviewing this topic. It will then describe the various devices used to protect both equipment and people from electrical shock. This will be followed by explanations of various electrical faults that must be protected against and how proper grounding and the use of these devices can be used to guard against hazards posed by these faults.

## Grounding

### *Theory*

While the resistance of soil is generally high, it is frequently a fairly good conductor from one point on the earth to another simply by virtue of the large cross-sectional area of this "conductor". An example of how the earth can be used as a conductor is the method of transmitting electricity over long distances, called single-wire earth-return (SWER). Early telegraphy systems also used the ground as a return conductor. In these cases, instead of using two conductors to transmit electricity as is conventionally done, the electricity is transmitted to the load in one conductor and returns back to the source through earth or the ground (Fig. 84). The electricity enters and leave the earth through grounding electrodes that can be in the form of a long metal rod, a sheet or ribbon of metal, or a matrix of reinforcing bar embedded in the concrete floor of a building.

While it was previously noted that most of the ground "conductor" has a low resistance because of its large cross-sectional area, this may not be true in the immediate vicinity of the grounding electrodes. In this area, the current must pass through the soil that has a relatively small cross-sectional area. This increases resistance to the flow of current. If grounding electrodes are used as protective measures with mini-grids, it is necessary to ensure that the resistance in the vicinity of these electrodes is sufficiently



low. This is requisite for the proper operation of some electrical components such as lightning arresters and, depending on system design, circuit breakers, and for the protection of individuals using the system. Several approaches for reducing resistance in the vicinity of a grounding electrode are discussed below (p. 123).

### **Types of grounding**

**Rod:** Grounding rods are the most economical means of grounding, require no excavation, and can be more easily driven deeper into the ground, where resistivity is less because of increased moisture. Deep ground rods are much less sensitive to seasonal variations than grounding systems installed near the surface that dries out during the dry season. Driving the rod into the ground also ensures a close, definite contact with the soil.

There are several types of ground rods. Solid copper gives excellent conductivity and is highly resistant to corrosion. But it is expensive and, being a soft metal, it is not ideally suited for driving deep in heavy soils. Steel rods, galvanized to reduce the chance of corrosion, are inexpensive and strong but the life of the galvanizing can be short in acidic soil. The best choice is a steel core with a copper cladding. The steel gives it strength while the copper exterior offers good conductivity and resistance to corrosion. Care should be taken to ensure that the copper exterior is more than a thin copper plating which might give the appearance of being a quality product but may be scrape off as the rod is driven, exposing the steel to corrosion.

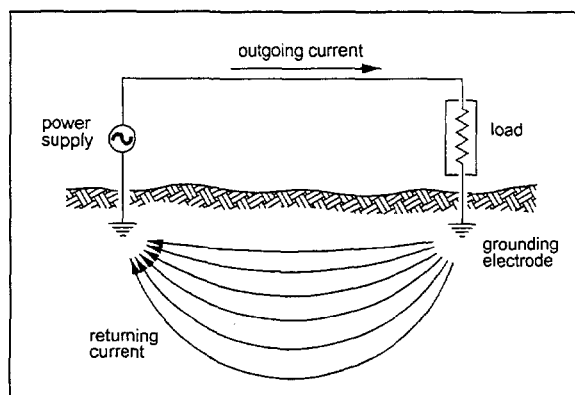
When installing a ground rod, if it is too long and cannot be driven further, the top should not be bent over. Bending the rod can break the protective layer and encourage corrosion. This will in turn reduce the cross-sectional area at the bend, increase the resistance at that point, and eventually cause the rod to rust through.

However, contrary to what might appear intuitively, the diameter of the rod has little impact on the ground resistance. Larger-diameter rod should only be considered when it has to be driven in hard terrain.

**Plate:** Plate electrodes are normally of cast-iron or copper buried vertically, with the center about a meter below the surface. These provide a large surface area and are used mainly where the ground is shallow. Disadvantages include the need for considerable excavation and susceptibility of variations in ground resistance as the water content of the soil changes over the year. With this type of electrode, the connection between the grounding lead and the electrode is located underground and is therefore subject to corrosion through cathodic action. Painting the connection with bitumen can protect this from happening.

### **Ensuring a good ground**

Going through the motions of installing ground electrodes does not ensure that these serve their intended purpose. This may actually be dangerous if it gives the false impression of safety where there is none. If a ground is made by inserting a short rod in dry soil, for example, it is possible for a "grounded" object to



**Fig. 84. Using the earth as a conductor.**

still be energized with 240 V, which could be fatal if touched. It is therefore important that a good ground is assured when it is installed and that it be maintained over its life.

To ensure proper operation of the ground rod, ground resistance should be low. One way of doing this is to extend the rod deeper into the ground. Research undertaken by the U.S. National Bureau of Standards concluded that doubling the length of the ground rod reduces resistance by 40 %.

Another option is to simply increase the surface area of the grounding electrode. While it would appear that this can be done by increasing the diameter of an individual electrode, research with grounding rods has shown that this only has a marginal effect. For example, increasing rod diameter (and its surface area) by a factor of 300 % only decreases resistance by about 20 %. (The only reason for considering increased rod diameter is when strength is required to penetrate hard terrain.)

While increasing rod diameter has little effect, increasing area by using a number of interconnected, but adequately spaced, electrodes seems more effective. However, resistance does not vary in inverse proportion as the number used, as might be expected. In addition, multiple ground rods should be spaced apart further than their depth of penetration to be effective.<sup>14</sup> In this case, increasing effective surface area by 300 % by using three adequately spaced grounding rods of the original size decreases resistance by about 60 %.

In areas served by a municipal water system, another way of increasing the surface of the grounding electrode is to use an existing cold water pipe on the consumer's premises. This is effective in cases where the entire water system is metallic. However, with the increasing usage of PVC pipe for water systems, the continuity is broken and this grounding may not be as effective as assumed.

A second approach is to reduce the resistance of the soil in the vicinity of the electrode. One way is to increase the moisture content of the soil in the vicinity of the electrode. Since the moisture of the soil usually increases with depth, this can be accomplished by driving the electrode deeper into the soil.

Another way is to chemically treat the soil in the vicinity of the electrodes (Fig. 85). This is also a useful approach when ground resistance is too high and ground rods cannot be driven deeper into the ground because of hard underlying rock that has more resistance than soil. Care must be taken to ensure that the treatment does not corrode the electrode. Magnesium sulfate, copper sulfate, and ordinary rock salt are suitable non-corrosive materials. Magnesium sulfate is the least corrosive, but rock salt is cheap and does the job if applied in a trench dug around the electrode. This method is not permanent as the chemicals are gradually leached away by rainfall. Depending on several factors, it may be several years before another treatment will be required. Chemical treatment also reduces the seasonal variation of resistance of the soil.

In areas of bedrock, with little soil cover, making good grounds is difficult. Drilling a hole into bedrock is necessary and generally requires access to a pneumatic drill. In this case, to

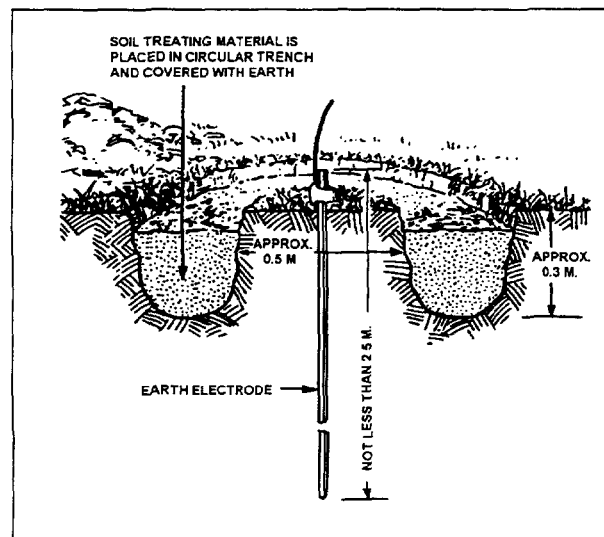


Fig. 85. Trench method of soil treatment.<sup>14</sup>

reduce ground resistance, an oversized hole is drilled, a grounding rod inserted, and the hole backfilled with concrete mortar or a sodium bentonite slurry. Bentonite is a clay mineral of volcanic origin mined in most continents and ground to various sizes. Like concrete, it is hygroscopic, i.e., it attracts moisture by chemically bonding with water. For this reason, these materials form a good conducting medium between the grounding electrode and the sides of the hole and a good bond to these two surfaces. It also increases the effective area of contact between the electrode and the surrounding rock. Sodium bentonite absorbs roughly five times its weight of water and expands to occupy more than 10 times its dry volume. It is applied in granular form so that it can be poured in place before swelling begins. In a borehole, the bentonite/water mixture should swell in less than a day. This material continues to draw moisture from the soil and air around it, thus maintaining its volume and low resistivity. However, in a very dry, desert-like environment, it will dry and shrink, drawing away from the embedded rod and increasing resistance rather than reducing it.

As noted earlier, a grounding electrode is usually more effective if it is installed in depth than if the same electrode is laid horizontally closer to the surface. However, under the latter circumstances, grounding can be improved by embedding somewhat more than 5 m of 5-mm diameter, bare copper conductor or the equivalent length of 12-mm diameter reinforcing bar (or properly bonded lengths of rebar) within or near the bottom of a concrete slab or footing in direct contact with earth. In this case, a conductor would have to be bonded to the steel or copper and brought out for connection. Concrete is not as conductive as bentonite, but it does improve electrical conductivity between the small diameter electrode and the earth.

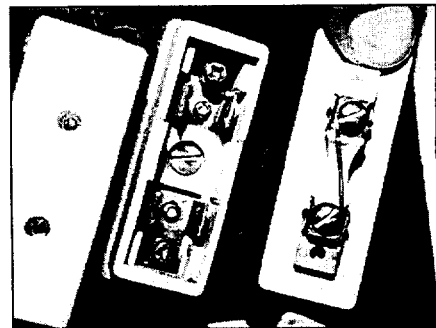
## Protection devices

### Fuses

A fuse is a device for opening a circuit by means of a conductor designed to melt when an excessive current flows through it. Two types are commonly used: the rewirable fuse (Fig. 86) and the cartridge fuse.

The principal feature of a rewirable fuse is that, once the fuse has blown, the fusing element or wire can be easily replaced at minimum cost. While these fuses may be convenient, low-cost, and popular, a principal disadvantage is that any inexperienced person can replace the blown fuse wire with one of incorrect size or one made of ordinary wire. Such an action completely negates the purpose of the fuse to open the circuit when current reaches an unsafe level and places the system in jeopardy. In one site visited, the continually blowing fuse was replaced by progressively larger fuse wire. In the end, the generator overheated and burned from the overload (p. 201).

Another disadvantage is that this type of fuse does not discriminate between a momentary high current that is acceptable (e.g., due to a motor starting) and a continuous overload current that must be interrupted. It also is not precise, because the actual fusing current depends on the ambient temperature and the length of the fusing element. Furthermore, the minimum current for the fuse to blow might be considerably (e.g., two times) higher than its current rating, making it possible for the line being protected



**Fig. 86. A rewirable fuse is screwed to the ceramic cover that is then snapped over the ceramic base, completing the circuit.**

to operate at a considerably higher current than it was designed for. The fuse can also deteriorate over time, causing nuisance interruptions of the circuit.

To address some of these drawbacks, the cartridge fuse was developed. In this design, the fusing element or wire is enclosed within a cartridge made of ceramic or glass and is less susceptible to deterioration in service. By being manufactured under controlled conditions, its current rating is more precisely known.

### **Miniature circuit breakers (MCBs)**

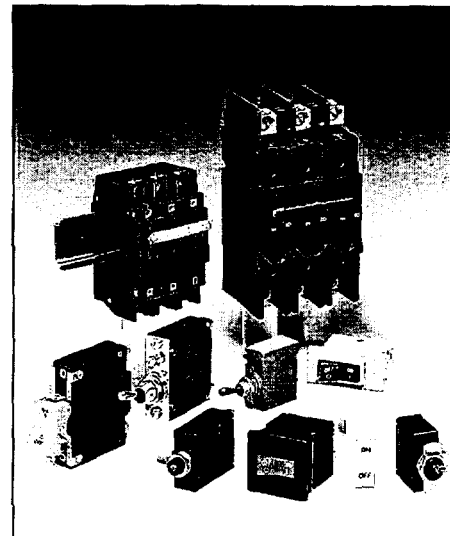
A circuit breaker is an electro-mechanical device that is designed primarily to automatically open a circuit when currents in excess of its design rating pass through (Fig. 87). Under normal conditions, a mechanism within the breaker holds the contacts in the closed position. The contacts are automatically separated when the release mechanism in the breaker is operated by magnetic and/or thermal means.

A magnetic breaker is tripped when excess current activates a solenoid. This pulls an iron slug into the solenoid's coil and collapses the attached tripping linkage to open the contacts. Such breakers have a very quick reaction time. A thermal breaker is tripped with excess current heats a bimetallic strip. The resultant deflection trips the release mechanism. Because of the time required to heat the bimetallic strip, reaction times tend to be slower. This might be more appropriate on a circuit with a motor, because a brief initial peak current demand in excess of the breaker's rated current is part of the normal operating cycle of a motor. A magnetic breaker used under these circumstances might trip each time an attempt is made to start the motor. Some breakers can contain both types of activation.

An ordinary switch is designed to make or break a current not greatly in excess to its normal rated current. A breaker can also be used to open a circuit manually, such as when work is undertaken on the circuit it controls (e.g., the housewiring). However, a breaker is capable of disconnecting a much larger fault current. Ordinary switches would spark excessively under similar conditions, possibly damaging the switch or even starting a fire.

While it is costlier than a fuse, a circuit breaker provides numerous advantages:

- It is easy to use and considerably more precise and more sensitive than a fuse.
- It can also be quicker acting; when small overload currents occur, the circuit breaker is likely to operate before the fuse blows.
- It can be tripped by a small sustained overload current but not by a harmless transient overcurrent such as due to the switching surge which accompanies the ignition of a fluorescent lamp.
- The breaker on a faulty circuit is easy to detect, because this is indicated by the position of the switch, and the breaker cannot be switched on as long as the fault condition remains.
- It can more conveniently be used as a switch when repairs have to be done to the circuit. It can be reset manually after a fault has been corrected, and no stock of fuses is necessary.



**Fig. 87. A selection of circuit breakers.** (Source: Airpax Protector Group, Cambridge, MD)

- It is factory-calibrated and cannot readily be changed.
- Under fault conditions, breakers positively disconnect all poles of the circuit it controls

The required capacity of the circuit breaker (or fuse) depends on its function. An overcurrent device at the powerhouse (or transformer, if the mini-grid is connected to a larger network) would be used to protect the generator or transformer from being overloaded. The capacity of an overcurrent device placed on the consumer's premises would depend on its function. If it is to ensure that the current does not exceed the capacity of the housewiring, then the size of the device would be set by this capacity. If it is to limit consumer-drawn power to a specific limit that determines his tariff, then the device would be sized according to this limit. For example, a household that has subscribed to a 50 W service would have a breaker that would trip if the demand goes significantly beyond this limit.

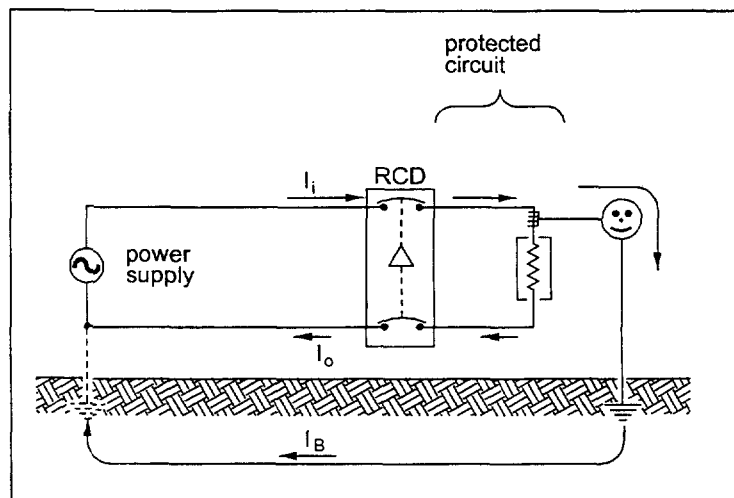
### **Residual current devices (RCDs)**

As is discussed below (p. 132), even very small currents can prove fatal. These currents are much smaller than those that can be detected by the standard fuses and MCBs discussed above. The RCD is a specialized form of circuit breaker developed to detect small fault currents that can pose a threat to humans.

An RCD, also called a ground-fault circuit interrupter (GFCI), is a device that is inserted in the circuit and located between the power supply and the circuit along which protection is sought, usually on the premises of the consumer (Fig. 88). This device is an automatic switch that senses the current into the circuit to be protected ( $I_i$ ) and compares it with the current out of this circuit ( $I_o$ ). Under normal operating conditions, these two currents should be equal, and the switch maintains the supply.

However, under fault conditions, such as when a person touches the live conductor, a portion of the current passing through the RCD into the protected circuit would then pass through that person ( $I_f$ ), leak into the ground, circumvent the RCD, and return through the ground back to the supply either through a system ground if there is one, through any fault, or simply through capacitive coupling between the circuit and the ground (p. 134). As soon as the RCD senses a difference ( $\Delta$ ) between the incoming and outgoing currents, it trips and isolates the protected circuit.

An RCD operates by detecting the difference in current flowing into and out of the protected circuit, independently of how well the generator is grounded or whether it is grounded at all. But incorrectly grounding the consumer circuit can prevent an RCD from detecting fault currents.



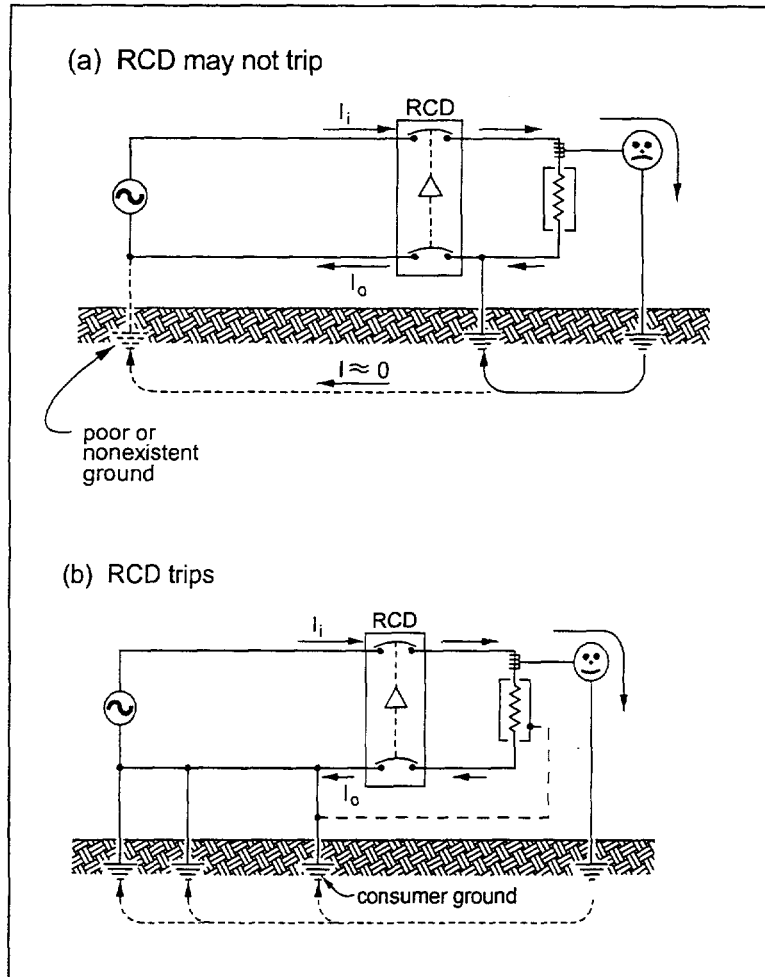
**Fig. 88. Potentially dangerous currents leaking through a person ( $I_f$ ) will cause the current in ( $I_i$ ) and current out ( $I_o$ ) of the circuit to be unequal, forcing the RCD to open the circuit.**

For example, if the neutral conductor were grounded on the consumer side of the RCD (Fig. 89a) and the generator ground is poor or nonexistent, a lethal fault current could flow through a person and return to the neutral conductor through this consumer ground. Since current both in and out of the RCD could then be roughly equal, the RCD may not detect the fault. If a consumer ground is used and if this is connected to the neutral conductor, this connection must be on the supply side of the RCD (Fig. 89b). Actually, the neutral conductor can be grounded any number of times between the RCD and the power supply and not adversely affect the operation of the RCD.

If the metal frame of a piece of electrical equipment is bonded to the consumer ground (represented by the dashed line in Fig. 89b), any leakage current to the frame caused by an internal fault would also cause the RCD to trip before it is even touched by a person.

While an RCD is always a useful device for protecting household members against accidental shock, this can be a relatively expensive device. In the U.S., single-pole RCDs incorporated in dual power outlets are available for about \$10. These are preset to trip at 4 to 6 mA. In the U.K., two-pole RCDs rated to trip at 10 mA cost roughly \$70. The least expensive units are those tripping at 30 mA but still cost about \$40. Because the danger from shock is minimal if loads are limited to lights and double-insulated appliances, RCDs for individual households are not essential.\* For more affluent consumers who are likely to use other appliances such as refrigerators, cookers, and machine tools, the use of RCDs should be considered, especially since these individuals can probably easily cover the additional cost involved.

\* Double-insulated appliances are those where the wires inside the appliance are insulated, where terminals are normally not in contact with the inside of any metal casing, and where any metal casing is enclosed in a plastic housing. These include appliances such as radios, TVs, and some power tools.



**Fig. 89. Proper placement of the RCDs is critical if these devices are to operate properly. Incorrect placement of the consumer ground may prevent the RCD from detecting a fatal body current (a). If the consumer ground is bonded to the system ground (larger dashed line), this should be done on the supply side of the RCD (b).**

Tripping of an RCD indicates a fault condition that must be corrected in order to remove the hazard that it will likely continue to present to equipment or people.

If the RCD resets and the person in the household knows what caused the tripping, the mini-grid operator can then be informed, isolate the supply for that premise only, and repair or remove the faulty appliance.

If the cause for the tripping is unknown, this must be investigated further by the system operator:

- If an RCD can be reset, this implies a fault that is temporary in nature, possibly caused by someone touching a faulty appliance. If the consumer does not know which appliance is causing that tripping, the system operator must investigate further. One way to accomplish this is to install a (temporary) consumer ground electrode if one is not already installed. All appliances should be disconnected from the protected circuit being checked. Each appliance is then connected, one at a time, to the circuit, the chassis is grounded through the consumer ground electrode, and then the appliance is switched on. If the RCD trips either when the appliance is connected or when it is switched on, the culprit load has been found.
- If the RCD still does not reset, the fault is probably permanent in nature and located in the equipment or cabling. The technician would first disconnect both output leads from the RCD. If the device can be reset, the problem is probably not a faulty device. He would then reconnect the RCD and progressively isolate further sections of the circuit, by temporarily disconnecting both conductors to those sections being checked until disconnecting one section or appliance allows the RCD to be reset. This indicates that the fault is located in the last disconnected section.

In both cases above, once the culprit has been found, it is necessary to find the source of the problem so that it can be repaired. A close inspection of the wiring and insulation may locate the cause of the fault. An ohmmeter might also be of some use.

## **Protecting the system**

### ***Protecting against overload currents***

Overload currents occur when too much load is placed on the circuit or generator. This type of overcurrent can be caused by connecting too many lights or appliances to the supply or by connecting up appliances, such as hot plates or irons, that draw too much current. Overload currents can be caused when switching on a motor, until it comes up to speed, especially if it starts under a load. During this period, additional current is required until the motor comes up to speed. If the motor is starting up with no load, e.g., the motor is connected to a rice mill but no rice has yet been placed in the hopper, the motor will start fairly quickly and the period of overload and the overcurrent will be minimal. If, on the other hand, the motor starts under load, e.g., a motor is connected to a pump at the bottom of a well, then the motor is pushing against the pressure of a full pipe of water as soon as it starts. It will take it longer to come up to speed, and the duration of the period of overcurrent will increase. Overload currents also can be caused by placing too much load on a motor after it has come up to speed, causing it to slow down or stall, such as a saw binding and stalling because the wood being cut is too wet and/or thick or the blade is too dull.

### **Impact**

Overload currents can be inconvenient and merely affect the performance of lights or appliances. For example, if in the evening too many lights have been turned on, the excess current causes an increased voltage drop in the distribution system, reducing the voltage that is available in the home or workplace.

As a consequence, light bulbs will dim and this lower voltage may make it impossible to even start a fluorescent lamp until the total load on the system has been reduced.

Overload currents can be dangerous as well, especially if they are sustained for long periods. The increased voltage drop that results can prevent a motor from getting the power it needs to start. It then comes up to speed slowly, drawing excess current in the process and exposing the wires to high temperatures due to this excess current. Overheating can cause an accelerated deterioration of the housewiring, generator, or motor insulation and its eventual breakdown, or even generate sufficient heat to cause a fire. It can cause sparks in a switch when the appliance drawing the excess current is switched off, damaging the switch. Without any protection, it can also damage the generator, inverter, or transformer providing power to the mini-grid.

### **Protection**

To protect the system against overload currents, either of two devices are commonly used: fuses or MCBs. These should be placed at the beginning of the mini-grid, i.e., in the powerhouse or at the transformer, to protect the supply from being forced to supply more power than it has been designed to generate and to protect the consumers from the effects of low voltage. These should also be placed on the premises of the customers themselves, primarily to protect them from drawing too much current and putting themselves at risk of fire or electrical shock that may result. This protection also protects the other consumers by isolating the offending consumer from the remainder of the mini-grid, permitting it to operate normally once the offending load has been automatically removed. Depending on the size of the mini-grid, additional breakers might be located at the beginning of each long branch of the grid. In case of an overcurrent on one branch, the MCB would open, isolating that branch until the problem is resolved but maintaining power to the remainder of the community.

Overload currents are not as large as short-circuit currents. Because the rating of fuses is not precisely known, it is possible for fuses not to blow even if overload currents exceed the fuse rating. For this reason, MCBs are often preferred to protect against overcurrents.

### ***Protecting against fault currents***

Fault currents between two conductors are caused under abnormal conditions when the close proximity or accidental contact of one conductor to another causes current to flow between the two. Fault currents which could prove hazardous to the system include the following:

- Short circuits between conductors. These could be transient, high-level currents such as would be caused by shorts within the system, when bare portions of the conductors supplying a load come directly into contact with each other. This could be caused by a falling branch or tree pulling down the distribution lines, causing uninsulated portions of the conductor to touch each other; a wire from a loose connection within an appliance touching the other wire; or a heavy object falling across a wire, cutting through its insulation.
- Leakages through insulation. These are sustained, lower-level currents caused by the leakage of current through degraded insulation. These currents can occur due to the breakdown of the insulation used with conductors, such as housewiring, or with insulation within an appliance, such as in the winding of a motor.



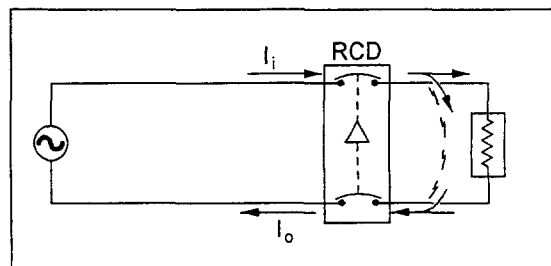
## Impact

Short-circuit faults can damage both line and equipment because of the potentially large currents involved and the heat that is generated. It may also cause fires. On the other hand, smaller leakage currents in themselves are not an immediate hazard. But even small currents can heat the insulation, further aggravating the situation over time, until a short circuit may eventually develop.

## Protection

Fuses and MCBs, installed in the powerhouse as well as on the premises of the consumers, are generally used to provide protection against short-circuit currents. These devices should already have been included in the system and sized to protect against overload currents (see previous section). Because short-circuit currents are considerably greater than overload currents, these devices will also serve to protect against the former. However, because of the large currents that short circuits can create, these devices must be designed to be able to safely accommodate these high currents as they open, without damage to themselves.

Leakage faults involving small currents flowing through degrading insulation along a conductor cannot readily be detected unless the problem is sufficiently advanced to generate the additional currents needed to trigger a fuse or MCB. The best protection is to use good quality insulated conductor of adequate size, taking precautions in the use of electrical equipment, and installing the housewiring in areas where it is not exposed to conditions that could initiate the deterioration of the insulation. It is important to note that short-circuit and leakage faults cannot be detected by RCDs. This is because, in this case, the incoming and outgoing currents through the RCD are equal (Fig. 90).



**Fig. 90. With a short circuit or leakage across wiring insulation, the current in and out of the RCD remain equal and the RCD will not trigger.**

Leakage faults involving currents flowing through the insulation to the frame of a piece of equipment could worsen over time if that equipment has been grounded through a consumer ground (as shown in Fig. 94). In this case, fault currents can flow back to the power supply through the ground, generating heat and causing the insulation to deteriorate further. Depending on the resistance of the ground, fault currents might be sufficient to trip a breaker on the consumer's premises. Chances for detecting such a fault would be considerably improved if an RCD were included on the consumer's distribution board (see Fig. 98b) and even better if the consumer ground were bonded to a multi-grounded system neutral (see Fig. 98c).

On the other hand, if that equipment is not grounded, the leakage problem may not worsen and cause the equipment to burn or otherwise fail. But in this case, it could prove a safety hazard to persons touching it. This is covered later in this chapter.

## Protecting against corrosion/oxidation

Whenever different metals are in contact, especially in a damp environment, corrosion can occur, the rate of corruptions being dependent on the type of metal, the dampness present, and the any contamination (such as salt spray from the ocean or contaminants in industrial emissions). This problem occurs

primarily at any connections between aluminum and copper conductors, such as between an aluminum distribution line and a copper service drop.

When exposed to air, the surface of aluminum rapidly oxidizes. The thin resistive film of aluminum oxide which results can prevent a good contact between it and another conductor, decreasing quality of service.

### Impact

If conductors of different materials are connected together, any corrosion which appears at their points of contact will lead to the gradual deterioration of the surface, increasing resistance and leading to an increased voltage drop at the interface. It is for this reason that special care must be exercised with working with connections between aluminum and copper.

Oxidation is mostly a problem at aluminum-aluminum connections where it forms a layer on the surface of a conductor that increases the resistance at the connection. Copper also oxidizes forming a resistive layer, but this is easily cleaned or simply broken down under the pressure of a connector.

### Protection

When making aluminum-aluminum or aluminum-copper connections, special care must be exercised, because the resistive oxide layer that forms on the surfaces of the conductor can result in poor connections. The section on joining conductors (p. 104) explains the techniques involved in making such connections and the precautions that must be taken into account.

## Protecting people

### Nature of the hazard

The generator in Fig. 91a generates 230 V and supplies a two-wire circuit that goes around the village. For any appliance such as a TV to work, electric current must flow through the TV from one side of the power supply (A) to the other side (B), thereby completing a circuit. The bulb is not lighted because the switch is open, preventing electric current from flowing around the circuit from point A through the bulb back to point B. As soon as the switch is closed, the circuit is completed, permitting the light to glow.

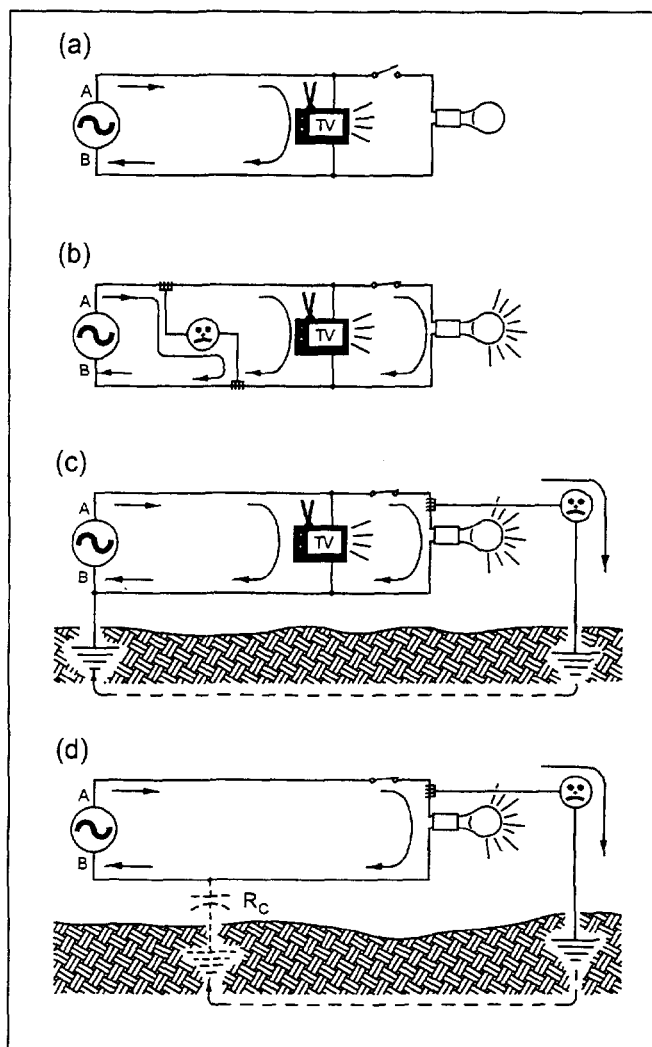


Fig. 91. A person can complete a circuit just like any other electrical component.

Now if a person accidentally touches each of the two wires as shown in Fig. 91b, that person also completes the circuit, and electric current will flow from point A to point B through him or her. The amount of current depends on the electrical resistance of the body at that time, which, in turn, determines the risk he or she faces. Human skin is quite resistant to electric current when it is dry, but when wet, its resistance is very low and fatal shocks can more easily occur.

Table 12 shows how much current flows through the body under different circumstances and the effects of that current on the human body. The threat posed by these currents through the body depends on both the magnitude of the current and the length of time contact has been made. The larger the current, the shorter the time it will take to do harm. The following sections explain several conditions that pose a hazard to people and how these can be protected against.

### ***Origin of body currents***

#### **Contact with both conductors**

##### ***Description***

The largest body currents are caused by a person directly touching both sides of a circuit with different parts of the body (Fig 91b). It might happen as someone is making repairs on the housewiring, without disconnecting the MCB or switch on the distribution board. This action can easily lead to fatal currents.

##### ***Protection***

Fuses or MCBs cannot be counted on to open the circuit during this type of fault condition. While someone touching both conductors will increase somewhat the current drawn from the generator and possible get a fatal jolt, this increased current is generally not large enough to trigger these devices. Even RCDs, which are designed to protect people from electric shock (p. 127), can offer no protection. The best methods of protection against this type of fault are proper housewiring, correct wiring of appliance fittings, good maintenance of insulation, and avoiding tampering with any part of the electrical circuit or appliances. Protection then essentially becomes a matter for consumer education and occasional inspections of the consumers' premises by a technician or system operator. There is no reason for this type of fault to occur unless one is playing with the housewiring or connections to electrical equipment

**Table 12. An estimate of the amount of current flow through the body under different circumstances when contact is made with wires at a standard distribution voltage. The effect of the current flowing through the body is also noted.**

<b>Conditions</b>	<b>Body current</b>	<b>Effect</b>
Dry skin	3 mA - 10 mA	Tingling sensation, slight shock.
Damp conditions, sweaty skin	10 mA - 20 mA	Tightening muscles, acute discomfort, and difficulty in separating from electrical contact. Prolonged contact harmful.
Damp conditions, sweaty skin, electrical contact with water	20 mA - 50 mA	Harmful, sometimes severely. Acute tightening of muscles, especially in the chest area.
Damp conditions, sweaty skin, electrical contact with water	50 mA and up	Usually fatal. Irregular contraction of heart muscles (fibrillation).

(such as sticking bare ends of wire in an outlet rather than using a proper plug).

### **Contact with a live conductor of a grounded system**

#### ***Description***

If the system neutral conductor is grounded, body currents can also result when someone touches only one side of the circuit (Fig. 91c). This is similar to the previous case because, while only one hand may be touching one side of the circuit, another part of the body (e.g., the foot) is touching the earth that in turn conducts current through to the system grounding electrode to the other side of the circuit. This completes the circuit through the person. The only difference is that the current passing through the person standing on the ground must also pass through his or her footwear as well as passing through the ground. This would generally offer somewhat greater resistance to current flow than in the case mentioned above, reducing somewhat the fault current through the person. But it can still prove fatal. And if the person is barefooted and/or if the ground is wet, the resistance is much reduced, significantly increasing the risk of shock.

#### ***Protection***

This condition should not normally occur if the housewiring and the wiring of appliances has been correctly installed, if quality materials have been used, and if one does not tamper with the wiring or appliances.

With this type of fault, protection can be afforded by using an RCD placed between the power supply and the points that could be touched. When the RCD senses a current imbalance because some of the current is passing through a person, it will open the circuit. However, for an RCD to function, the neutral conductor should only be grounded on the supply side of the RCD (see Fig. 98c at the end of this chapter illustrates where the system neutral should be grounded).

### **Contact with a live conductor of a floating system**

#### ***Description***

Even if no system ground is used, as is typically the case with mini-grids (i.e., the system is floating), body currents can still be generated when only one side of the circuit is touched. While there may be no physical connection between any part of a floating system and ground, capacitance between the various components of the systems (such as the generator and the distribution line) and the ground constitutes a return path for alternating current, although one with considerable reactance (i.e., resistance to current flow) depicted by  $R_C$  in Fig. 91d. Consequently, this is similar to the previous case, except that in this case, there is yet greater resistance in series with the person, further reducing the size of the fault current. But a dangerous current can still exist, depending on actual reactance to ground and body resistance.

#### ***Protection***

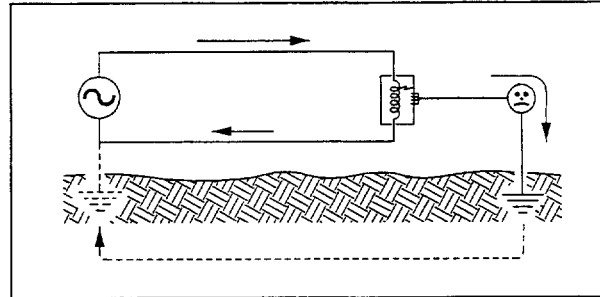
The same means of protection can be used as were used as protection against the previous type of fault—proper design with quality materials and an RCD.

### **Contact with live appliance**

#### ***Description***

The discussion above has focused on body currents caused by touching a live conductor. This situation should rarely if ever occur under normal circumstances. However, a potentially more hazardous situation—more hazardous because it might be encountered more frequently—occurs when a person in

contact with the ground touches an electrical appliance, such as a radio, refrigerator, or cooker with an energized metal housing (Fig.92). This may prove an unexpected hazard because the appliance is designed to be handled (a refrigerator door to be opened or a power tool to be held), but it is usually not possible to visually determine whether or not this appliance is energized.



**Fig. 92. A fault in an appliance can lead to a fault current passing through a person touching it.**

An appliance may become energized when a breakdown of the insulation occurs within the equipment or when a wire used internally

becomes frayed. This fault places a voltage on the housing of the appliance. While this in itself may not place the appliance at risk, someone touching this appliance and standing on the ground would complete a circuit, as in the cases just discussed. The return path for the current would be through the system ground (see dashed line in Fig. 92), whether it is through a physical connection between the ground and the neutral conductor or through capacitive coupling between the two.

If the fault has a high resistance, resulting in very low body currents, this might just cause a tingling sensation. But even this could prove of nuisance value as it may, for example, make the system operator apprehensive about touching the powerhouse equipment that he should be adjusting during the operation of the plant. On the other hand, under certain circumstances it could lead to a fatal current.

### **Protection**

As with several of the other fault currents, these currents are usually relatively small (but could still prove fatal) and cannot be detected by fuses or MCBs used to protect against shorts or overcurrents. Several options for protecting against this hazard are possible. To avoid unnecessarily increasing the cost of electrification, the system designer must select the option that is the least expensive and involved, yet one that does not compromise on safety.

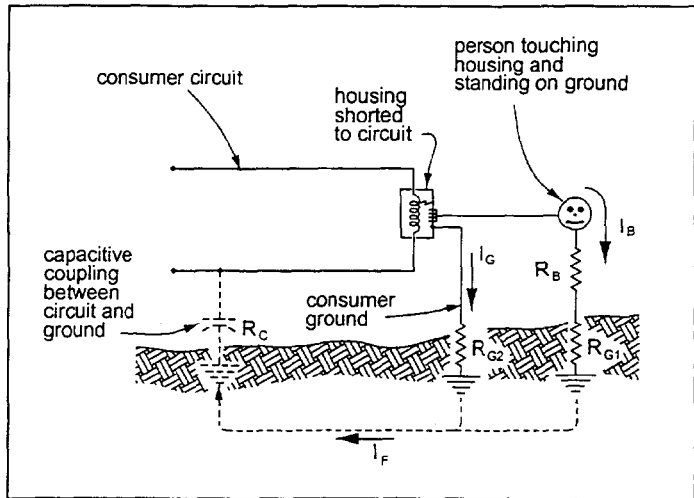
The most appropriate option depends on such factors as where protection is sought (i.e., on the consumers' premises or in the powerhouse), what end-uses are envisioned, and whether the system is floating or grounded.

**Consumer protection:** The protection required is determined by the potential hazard that each end-use might pose:

- **Lighting and entertainment.** If the appliances being used do not have a metal housing that can become live or energized, then this threat does not present itself and there is no need for additional protection. This is the case in many rural homes, where end-uses are limited to light bulbs with plastic light switches and to TVs and radios with plastic housings. In this case, RCDs, consumer grounds, or the grounding of the system neutral are not necessary. The system should be left floating (ungrounded).
- **Other end-uses.** More sophisticated end-uses, especially appliances with housings that can conduct electricity, such as some power tools, rice cookers, motors, or refrigerators, are more likely to present a threat to personal safety. Three approaches for protecting against this threat

are described below. Each of these approaches can be used alone; together they provide an increase safety factor (at a financial cost).

- Using double-insulated appliances. A fault current through the housing cannot occur if it is entirely manufactured of an insulating material, such as plastic. Double-insulated appliances should be purchased when available; these use properly insulated internal wiring and have a non-conducting exterior.
- Using a consumer ground. If



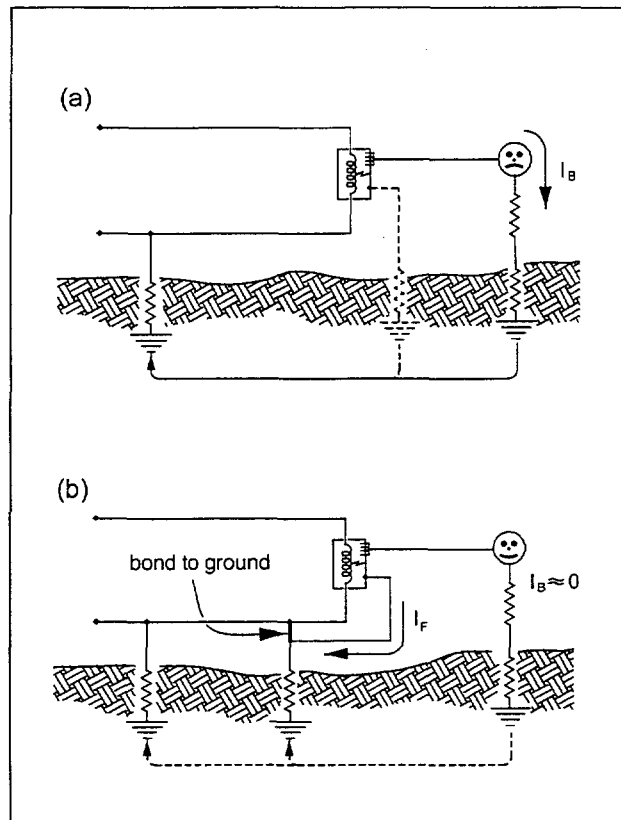
**Fig. 93. The resistances and reactance encountered when an individual comes into contact with a faulty appliance. This circuit is floating but includes a consumer ground.**

the system is floating as is shown in Fig. 92, no physical connection exists between the conductors and ground; the only connection is through capacitive coupling (shown by the dashed grounding symbol). If a person comes into contact with the housing of a piece of equipment in which a fault has occurred, the entire fault current would pass through the body. What happens in this case is illustrated in Fig. 93 (leaving out the consumer ground for the time being). The magnitude of this fault current  $I_B$  is calculated by dividing the impedance of this portion of the circuit (equal to the vector sum of body resistance,  $R_B$ , ground resistance,  $R_{G1}$ ; and capacitive "resistance",  $R_C$ ) into the total voltage that appears across this impedance. These variables are defined in Fig. 93 which is a representation of what is happening in Fig. 92, except for the addition of a consumer ground. (Fig. 95a in Box 7 presents a quantitative example). Because the capacitive "resistance" (properly referred to as reactance) is relatively high for a small system, the amount of fault current flowing through this circuit and, therefore, through the person is largely limited by this reactance.

Now, adding a consumer ground provides a parallel path for this current; however, it does not significantly decrease the total impedance and therefore does not noticeably increase the total fault current,  $I_F$  (compare the first equation in Fig. 95a and 95b). But what is important is that the consumer ground provides a lower resistance path to ground, diverting most of the fault current that would otherwise pass through the person and reducing the current through the body ( $I_B$ ) to a safer level, depending on the effectiveness of this consumer ground (compare the second equations in Figs. 95a and 95b).

If the neutral conductor were grounded, then the entire fault voltage would appear across the person and the ground, independent of whether or not a consumer ground were used (Fig. 94a). Unlike the previous case, the low-resistance connection(s) between the neutral conductor and the ground would lead to a high fault current, and the consumer ground generally would not reduce body currents to acceptable levels as in the previous case described above. It might only succeed in doing this if the consumer ground has a very low ground resistance, something frequently difficult to achieve in practice.

The required protection in this case would be to bond the housing to the system (neutral) ground (Fig. 94b). This would place the housing at the same voltage as the neutral conductor that is already grounded and reduce any body currents. Furthermore, if any short should occur within the housing, the ensuing high currents through this bonded ground (because of the low resistance) will more likely be sufficient to trip the MCB or blow a fuse on the distribution board, isolating the faulty circuit and removing the threat to a person. But even if the fault current were inadequate to accomplish this, the bonded circuit would place the housing at ground potential, removing any voltage difference across the person and, therefore, reducing any body current to zero. Therefore, to ensure a safe system when the system neutral is well-grounded, a consumer ground should be included on the premises and also bonded to the neutral.



**Fig. 94. For a system with a grounded neutral, also bonding the consumer ground on his or her premises to the grounded neutral conductor ensures a safe environment.**

In this case, this consumer ground is redundant if the system neutral remains correctly grounded. However, if for some reason the system grounds fail or the neutral conductor breaks, the consumer ground will again resume its role of diverting a portion of any fault currents from the equipment frame to ground, thereby reducing potential fault currents through the person touching the equipment. But depending on actual grounding resistances, adequately lowering fault currents to completely eliminate the threat of shock cannot be guaranteed.

- Using an RCD. While each of the options described above would reduce the threat of electrical shock to individuals on the premises due to faulty appliances, a properly installed and functioning RCD can always ensure a safe environment. The only drawback is cost. If an RCD is included in the household circuit served by a grounded system, with metal surfaces of electrical appliances bonded to the system neutral, it is essential that such bonding is only located between the supply and the RCD (see Fig. 98c). Otherwise, the RCD may not function because any fault current may return to the supply by first going back through the RCD rather than through the system ground.

If consumer grounds are used, it is also possible to use a single RCD to provide some protection from equipment faults to a number of consumers who are located between the

### Box 7. Operation of a consumer ground

For this example, it is assumed that Fig. 93 represents a simple single-phase circuit supplied by a floating, three-phase 240 V power supply (i.e., the neutral conductor is not grounded). It supplies electricity to an appliance whose wiring is shorted to its metal frame near the live end of the appliance.

Fig. 95a describes what is happening in Fig. 93 without a consumer ground. If an individual touches this frame, current will flow through his or her body, encountering body resistance ( $R_B$ , perhaps 1500 ohm), a resistance into the ground in the vicinity of his or her feet ( $R_{G1}$ , perhaps 500 ohms), and a capacitive reactance ( $R_C$ , perhaps 6000 ohm). Then, if the voltage across this total resistance is 240 V, the total fault current that would all pass through the person will be about  $240/6300 = 38$  mA, which could prove harmful.\* Note that the fault current through the person's body ( $I_B$ ) is most prominently affected by the high capacitive reactance and is not significantly affected by resistance through the person. For example, if the person were standing on wet ground with zero resistance ( $R_{G1} = 0$ ), the current would then increase only marginally to  $240/6200 = 39$  mA.

If a consumer ground is installed, with a ground resistance of perhaps 300 ohms, this would, as before, have little effect on the total fault current (Fig. 95b). This would now increase slightly to  $240/6000 = 40$  mA. But more important is the fact that this current now has two paths to follow to ground (through the consumer ground and through the person). Because of the lower resistant path through the consumer ground, most of this current (35 mA) will pass through that path, leaving only 5 mA to flow through the person. This significantly decreases the threat to the person. This threat can be reduced further if, for example, the person is wearing shoes with rubber soles. Because rubber is an insulator, this would further increase grounding resistance between the body and ground and further decrease the portion of the current passing through the body.

\* Note that total resistance is the vector sum of resistance and reactance, that is,

$$R_T = \sqrt{(1500 + 500)^2 + 6000^2} = 6300 \text{ ohm}$$

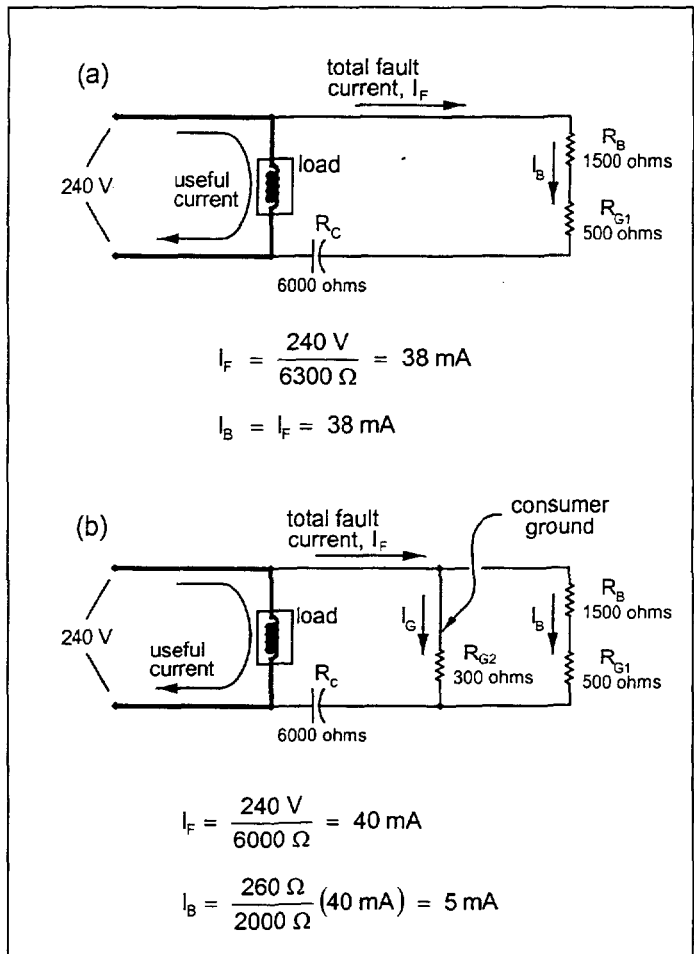
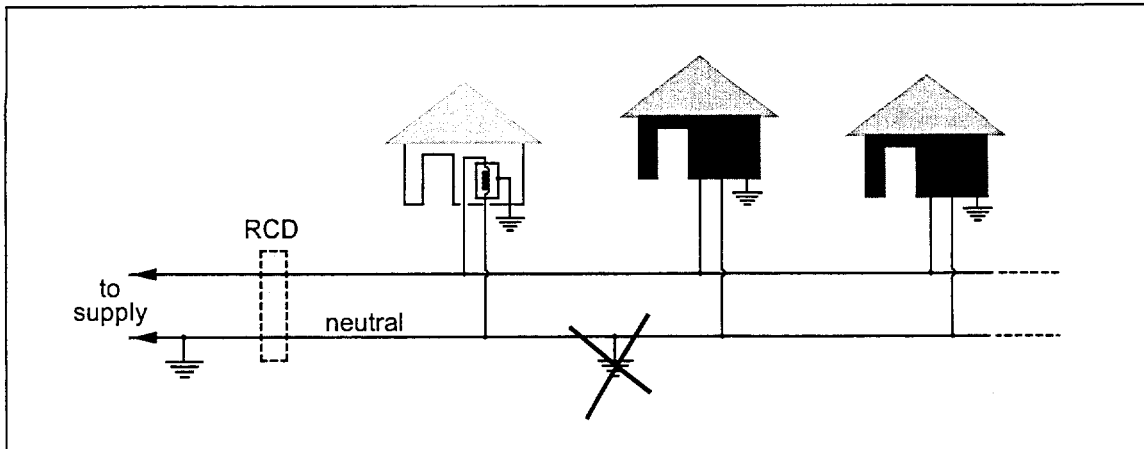


Fig. 95. Calculation of currents  $I_B$  passing through an individual (a) without and (b) with a consumer ground.





**Fig. 96. Using an RCD to protect against leakage currents caused by faults within equipment which is grounded through a consumer ground.**

RCD and the end of the line (Fig. 96). For this approach to work, the neutral on the consumer side of the RCD should neither be bonded to the consumer ground nor be grounded. When used in this manner, the current difference sensed by the RCD will arise both from equipment faults being considered here as well as from miscellaneous leakage currents elsewhere on this protected part of the system. Therefore, the rating of the RCD has to be sufficiently high to avoid nuisance tripping yet low enough to sense the fault currents being protected against. While an RCD used in this manner could detect the larger currents arising from faults within the various equipment, it should not be relied upon to detect the smaller fault currents that might pass through an individual. In using this design, individuals are protected only insofar as the RCD trips due to a housing-to-ground fault sensed before an individual touches the faulty equipment.

**Powerhouse operator protection:** While, in many cases, no ground may be necessary on the consumers' premises because no uses beyond lighting and entertainment are contemplated, the powerhouse clearly does contain several points that might accidentally become energized and prove hazardous to operating staff. These include the housing for the generator, the diesel engine, and the breaker box and/or distribution board (if constructed of metal). An RCD cannot be used to protect from faults or stray voltages in the generating equipment.

- If the system is floating, a powerhouse ground to the generating equipment can be used to reduce fault currents in the same manner as was achieved with the independent consumer ground described previously. This provides an alternative, lower resistance path for a fault current around the person touching the equipment.

Since concrete conducts electricity as does earth, the concrete foundation on which a generator is mounted might serve as part of this grounding system for a village power station (if the generator is firmly bolted to this foundation). Its effectiveness can be increased by welding the anchors of the generator to the rebar before the foundation block is cast. The effectiveness and area of influence of this "mat" to provide protection to the operating staff can be supplemented by placing a 5 to 10 mm<sup>2</sup> bare copper conductor in a firmly packed trench perhaps 0.10 m deep. (A larger conductor is not necessary because a conductor that is used solely to provide protection to the operating staff need not be designed to handle a large current.) This conductor could be in the

form of a loop perhaps 0.30 m beyond the base of the genset, immediately below the area where the powerhouse operator might be standing. This loop should also be firmly connected to the generator housing, perhaps at the generator mounting bolts and the other end can be connected to a grounding electrode. This electrode should be installed in a protected (i.e., little traveled) area just beyond the perimeter of the powerhouse to reduce possible tampering as well as increase the chance that it is in more moist, and therefore more conductive, ground. It is important that the integrity of this grounding system be maintained and that it is not possible, for example, for someone to trip over the grounding wire and pull it out of the ground, breaking the connection. Any other metal surface or junction boxes that are associated with the electrical system in the powerhouse should also be well interconnected to this grounding mat.

- If the system is well grounded, then as in the case of the consumer circuit, the equipment ground and system ground should be securely bonded together.

### **Lightning protection**

When lightning discharges in the vicinity of a distribution line, a high voltage is induced in the line which can break down the insulation on the windings of transformers or generators connected to the line or damage electronic equipment in the home or powerhouse. The associated high currents may also generate large amounts of heat and release considerable mechanical force. The purpose of a protective system is to divert these very high transient voltages and currents into the earth where they can be safely dissipated or to shunt these around rather than through devices that need protection.

Commercially available lightning arresters come with a weatherproof enclosure, connection leads, and a mounting stud or bracket. They should be connected to the distribution line, close to the equipment or accessory requiring protection, such as just outside the powerhouse or the service entrance (Fig. 97). At each of these locations, an arrester should be connected between each of the phase conductors and a common ground electrode, whether or not the system neutral is grounded. When the lightning-induced high-voltage peak on the distribution line reaches the arrester, it acts as a switch, permitting the passage of the current and voltage peaks down into the ground through a ground rod. The voltage differentials between the phase conductors are thereby reduced to safer levels. Once the voltage peak has passed, the arrester automatically shuts off any further current flow. Furthermore, the leads to and from a lightning arrester must be as short as possible and not coiled as shown in Fig. 97, because these factors increase impedance (opposition to current flow) to ground. With a large, rapid, lightning-induced current surge through arrester and the leads, any voltage drop due to current flow through this impedance adds further to the line-to-ground voltage and the net voltage could remain at troublesome levels.



**Fig. 97. Three lightning arresters on a three-phase, four-wire line just outside the powerhouse.**

For application on a distribution line, two types of arrester are commonly used: metal-oxide varistors (MOVs) and spark-gap type surge arresters. The first is made of a metal which temporarily loses most of

its resistance when a large voltage is imposed across it and then shuts off when the voltage peak has passed. The second is comprised of an air gap across which a current surge jumps when sufficient voltage is applied, with the spark extinguishing itself after the voltage peak passes.

Lightning is usually of less concern with low-voltage lines than with medium-voltage lines because the former tend to be lower to the ground and located among dwellings and trees where exposure to lightning is reduced. However, in areas where lightning is a frequent occurrence, low-voltage arresters can be installed at the service entrance.

Because solid-state electronics are sensitive to voltage surges, further protection is recommended for radios, TVs, or other electronic equipment is used in the home where lightning is a problem.. Unless grounding resistances are very low, i.e., less than an ohm, higher than normal voltages may still appear between the phase conductors in the home. To address this problem, surge suppressors are used and should be installed either just before the leads enter the equipment or in the equipment itself.

### ***Consumer and operator education***

One of the best ways of preventing people from receiving electrical shock is to ensure that system operators, and the consumers themselves, have a good understanding of how shocks occur. They will then be in a better position to avoid this type of danger. A program of consumer education on the safe use of electricity is essential at the time of system commissioning and at periodic intervals after commissioning (p. 173). A well-illustrated maintenance and safety manual for system operators should accompany every distribution system. And periodic visits should be made to individual consumers to observe how they are using the system and to observe any dangerous situations, e.g., hooking clothes hangers on wiring, unauthorized connections, faulty plugs, wire insulation damaged by proximity to the cooking fire, etc.

## **Summary**

Fuses, MCBs, and RCDs are generally used for protecting the system from excess currents that can damage the system or provide a safety hazard to people. Grounding can also play an important role. However, because incorrectly installed grounding can pose an increased hazard, it is important that grounding not be installed as an afterthought, in the hope that it will automatically make the system safer; it could have the opposite effect.

The final section in Chapter VI provides guidance as to when a mini-grid can be floating and when it should be grounded (p. 60). The following summarizes options for protection under these two scenarios:

1. **Powerhouse:** In all cases, a ground should be included in the powerhouse as protection for operators within the powerhouse (Fig. 98abc). This is in part accomplished by bolting the generating equipment to a concrete foundation block, if one is included. A grounding loop also connected to this equipment should be buried a short distance below ground level around this equipment and firmly bonded to a grounding rod. In addition, all metal housings within the powerhouse that contain electrical equipment should be tied into this ground. If the system is floating and a fault arises in the generator, this ground will provide a low-resistance path for most of the fault current to follow, reducing current through anyone touching the equipment (paralleling the operation of a consumer ground, p. 136). If the neutral conductor is also grounded, then the powerhouse ground should be bonded to the neutral conductor. This will

reduce the voltage across people touching the generating and control equipment and largely eliminate any fault currents through that person.

2. **Consumer:** The consumer protection required depends on the sophistication of the users. Note that in all cases summarized below, a RCD can be used to protect the user, whether the system neutral is grounded (Fig. 98c) or not (Figs. 98a and 98b). However, because the relatively cost of an RCD can make electrification less accessible in cases where disposable income is limited, it should be used where necessary and no cheaper alternative exists.

- For a basic system commonly found, which mostly serves lighting and entertainment end-uses, no special protection is necessary in the home because the threat of touching any energized conductor or metal surface which may be live is minimal. Radios and televisions are generally housed in plastic and double-insulated. A floating system is adequate.

If one or more power outlets are included in the home, there is increased danger from either children playing with these outlets or adults trying to energize appliances without the proper plugs (e.g., slipping bare ends of wires into the outlet). RCD could provide some protection (Fig. 98a), unless the person places himself across both openings of the outlet, effectively shorting the conductors. Placing outlets out of reach of smaller children is another action that could be taken.

For the occasional consumers who might have more sophisticated end-uses (refrigeration, power tools, pumps, cookers, etc.), a fault within the equipment can energize the equipment housing or frame, creating a fault current through anyone touching this equipment. (Even if the system is floating and no part of the system is physically connected to a ground electrode, the system is grounded through capacitance between the generator and conductor and the ground.) As illustrated in Box 7, a consumer ground on those premises will reduce any fault currents through a person that might arise due to his or her touching faulty equipment (Fig. 98b). Alternatively, an RCD can be included on the premises to isolate the consumer circuit if a fault occurs within the equipment. Then, if resistance to ground through this capacitance is sufficiently low to provide a current that can be of danger to people touching the housing, the fault current within the equipment should then be sufficient to trigger the RCD and insolate the offending circuit until the fault is found.

- For a system that is supplied by a medium-voltage grid extension through a distribution transformer, a grounded neutral system may be used if this is accepted practice. A conductor

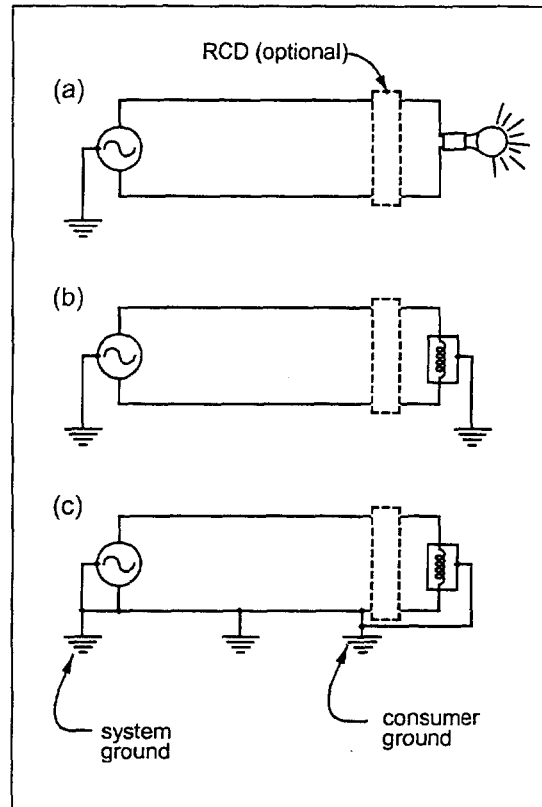


Fig. 98. Grounding options for a mini-grid.

should be used to connect all metallic housings on the premises and this should be bonded to the system neutral conductor. Multiple grounds along that neutral will ensure a safer system by providing redundancy and reducing system resistance to ground. Currents originating from a fault in the equipment housing would go directly to the system neutral and encounter minimum resistance. This encourages high fault currents that may trip the MCB or fuses on the distribution board and isolate the circuit. Even if this does not happen, the low resistance path from housing to ground would remove any voltage across a person touching the faulty equipment, removing the threat of a fault current. An RCD could provide added security provided it is properly positioned (Fig. 98c)



## XII. Service connection and housewiring

### Service connection

The service connection consists of two components:

- **The service drop.** This includes usually two, but occasionally three or four, conductors between the consumer and the distribution line; their connections to the distribution lines; and their connections to the entrance of the consumer's residence or business (Fig. 99).

In most cases, the service drop is comprised of overhead conductors. This implies easier and lower-cost construction and permits more flexibility if that is needed after construction of the mini-grid, such as to accommodate a change in the location of the residence on the property or a replacement of a temporary structure located on one part of the property with a more permanent one elsewhere on that property. For these reasons, an overhead service drop is what is assumed in this section. Occasionally, an underground service connection is used, as in the case of the GECO projects implemented by the French in several countries in Africa (see p. 192).

- **The service entrance.** The service entrance is comprised of the elements necessary to take the electricity from the service drop to inside the customer's premises. Conventionally, the service entrance includes the conductors and associated hardware from the service drop to the meter, the meter, and in some places a disconnecting device. For mini-grids, the meter may be omitted and the service entrance may lead directly indoors to the customer's distribution board or junction

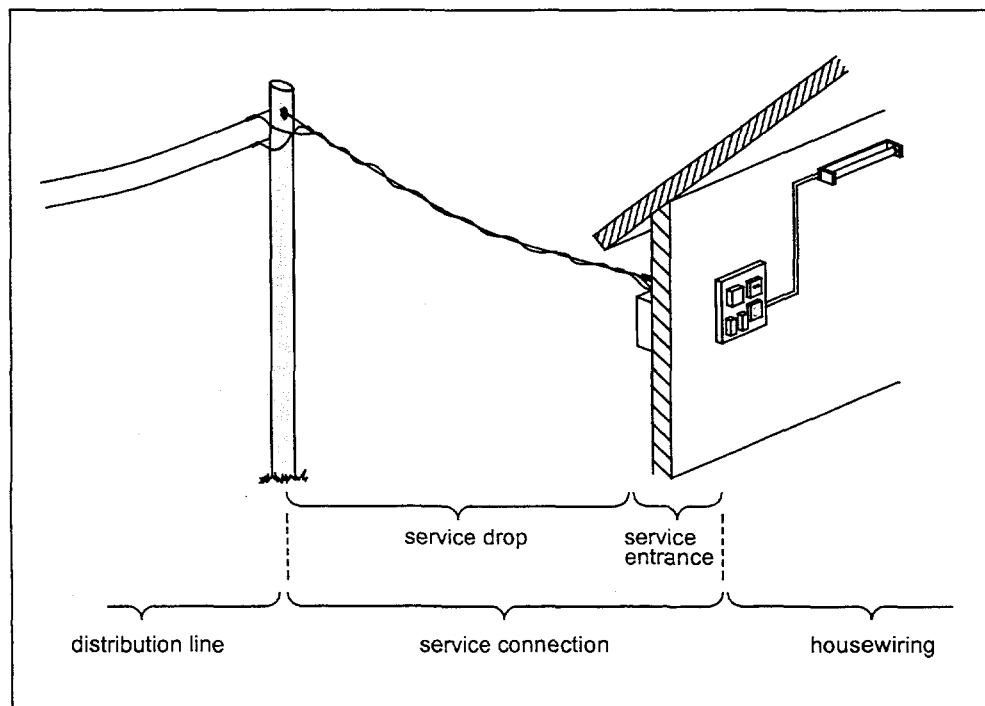
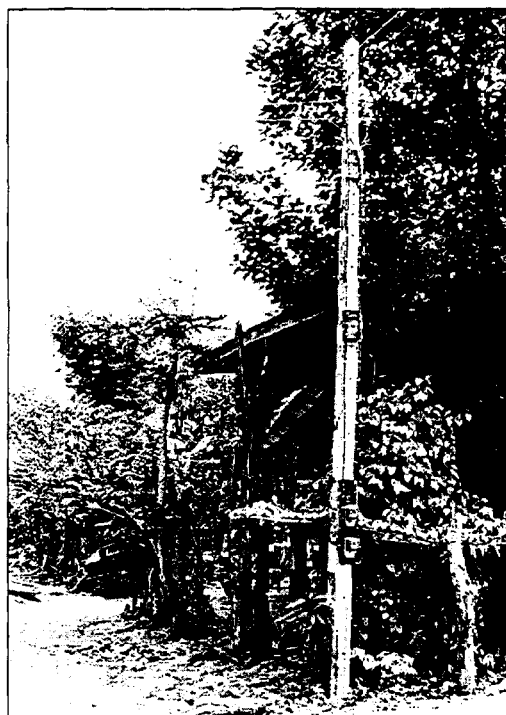


Fig. 99. The basic components to deliver power from the distribution line to the user.

box, which might then include a current-limiting device as an alternative mechanism to a meter for controlling/monitoring electricity use (see "Metering", p. 153). Or the meter and the customer's distribution board may both be replaced by a single device, such as the prepayment meters being widely promoted in the Republic of South Africa.

In some countries, the meters or current-limiting devices are placed on the power pole itself, before rather than after the service drop (Figs.100 and 132). Access to these for meter reading or repair may even require the use of a chair or even a ladder. While such a placement minimizes the chances of tampering, this option is not recommended because it makes accurate meter-reading difficult. If current limiting devices are affixed to the pole, this makes replacing or resetting the fuse element or breaker difficult. Furthermore, a consumer might be tempted to climb up the pole to reset the current-limiting device to turn on his power and thereby puts himself at risk by coming into contact with energized lines.



**Fig. 100. In Thailand, meters are commonly mounted at all heights on the nearest pole.**

### **Service drop**

#### **Conductor type**

While bare conductor can be used for a properly designed main distribution grid, it should not be used for service drops for mini-grid systems. Bare energized conductors connected directly to a consumer's dwelling pose a high risk to electrical hazards to the general public.

Of the conductors described in Chapter VII, multiplex conductor is specifically designed for service drop installation, and hardware exists for deadending, splicing, and connections. When available, it should be used in cases with the level of consumption found in industrialized nations, i.e., hundreds of kWh per month.

However, such high usage is unusual on mini-grids. Therefore, smaller insulated, single-core copper conductor is the most commonly used for service drops. This is especially so in unregulated installations because the installation is inexpensive and literally can be done by anyone who can connect wires. Unfortunately, these individuals may also have little concern for, or knowledge of, the safety hazards or electrical or mechanical limitations involved.

This type of service drop has the highest failure rate. Because of the conductivity of copper, a fairly small conductor is required to serve the purpose if it is selected on the basis of limiting the voltage drop along the service drop to a specific value. This is even more the case for mini-grids, where consumer demand is typically very low, further reducing the required conductor size. For example, if the voltage drop along a 230-V single-phase service drop were restricted to only 1 % and if several inefficient incandescent lights



and a TV were the only end-uses, then 1-ampere service would provide 230 W which would be more than adequate.\* A copper conductor as small as 0.5 mm<sup>2</sup> in area would transmit this power a distance of about 30 m and still satisfy these conditions. Alternatively, if each home had only one capacitor-corrected fluorescent lamp which each consumed a total of 30 W (i.e., with losses), a 0.5 mm<sup>2</sup> service drop could serve 4 homes evenly distributed along 100 m length of service drop strung from house to house. For this reason, the minimum size conductor is restricted more by physical strength requirements than by its current-carrying capacity. Due to the small size of conductors involved (usually less than about 3 mm<sup>2</sup>), the installations overstress the cable for what it was intended. Long spans will break at the fastening point due to fatigue of the copper as a result of movement caused by wind and mechanical stress.

When compared with copper, aluminum conductor is less expensive but has 60 % more resistance than a copper conductor of comparable size. Furthermore, when used for service drops to meet small power demands, small aluminum conductor faces the same problems noted previously for copper.

In summary, for the typical mini-grid project, individual consumer loads are often very small. Furthermore, costs must be minimized in order to make electricity more accessible to households in the community. Based on the good conductivity of copper, small conductor could be used but, as mentioned above, the conductor is susceptible to breaking through fatigue. Larger copper conductor might be used simply because of the increased strength that it offers, at an additional cost. One approach for making use of the large current-carrying capacity of copper conductor while avoiding the need to purchase large conductor simply to satisfy strength requirements is to use a homemade duplex option described in Box 8. This capitalizes on the use of good conductivity of copper conductor and the strength of steel conductor to come up with a cost-effective hybrid. But because the steel wire would be bare, use of this option should be restricted to systems where the neutral conductor is properly grounded. Alternatively, PVC-coated steel fencing wire might be used.

### **Conductor Sizing**

In various countries, national electrical codes have been established to serve as guidelines to be adhered to in order to ensure the design of a safe electrical system. But one has to apply such codes judiciously because they have generally been designed to address conventional needs found in urban areas where constraints are often different from those found in rural areas. For example, minimum conductor sizes have been established by the need to ensure that adequate capacity is available to meet the load that might be expected in urban areas. This is often well in excess of what is found in rural areas and, in these cases, abiding by these guidelines unnecessarily increases the cost of electrification, making it less accessible to rural communities.

As with the sizing of conductors used for the main distribution line, one important factor affecting the size of the conductor used for the service drop is the acceptable voltage drop along this section of line. This is usually set at no more than 1 to 3 % under maximum consumer load. The acceptable value is somewhat affected by the actual size of the voltage drop already incurred through the distribution line from the powerhouse up to that point.

The size of the service drop conductor required so that the voltage drop at the end of the line does not exceed the desired value (see above) is calculated with the same equations used to calculate the size of the

---

\* It might be noted here that, even in rural homes connected to the national grid, a peak coincident power demand of about 250 W per household is common in many parts of the world (unless the electricity is so heavily subsidized that it encourages unnecessary over-consumption and waste).

**Box 8. Homemade duplex service drops for households with small power demands.**

The principal justification for using a conductor that is larger than that required to achieve an acceptable voltage drop is to ensure its structural integrity over its lifetime. An alternative approach is to use a much stronger galvanized steel conductor as a messenger wire to provide all the tensioning strength and to support the much smaller insulated copper conductor that is required to serve the small loads typically encountered. In this case, the steel messenger wire would serve two purposes: in addition to supporting one length of copper conductor, it would also serve as the second conductor (the grounded neutral) for this single-phase service drop.

The usual argument against using steel as a conductor is that steel has 11 times the resistance of copper. Therefore, a steel conductor must have a diameter of slightly more than 3 times that of a copper conductor to have the same resistance. However, this presents no real obstacle because it is still cheaper than the copper conductor it replaces. Furthermore, the principal cost savings from using this homemade duplex is the much smaller and cheaper copper conductor that can be used to serve small loads.

Because of its limited current-carrying capacity, this small duplex conductor should only be used if the supply is current-limited and uses a device such as a PTC thermistor, fuse, or miniature circuit breaker (see alternative approaches to metering, p. 155). Otherwise the current-carrying capacity of the conductor might be exceeded or excessive voltage drops might adversely affect the performance of the consumers' loads.

The preferred insulation for the copper conductor is cross-linked, carbon-impregnated polyethylene (XLP). Otherwise, conventional carbon-impregnated polyethylene would be a very good second choice. Polyvinyl chloride (PVC) insulation may or may not provide long-term insulation because of the adverse effects of exposure to the UV, rubbing, etc., on this material.

To prepare this duplex conductor for use only with systems with a properly grounded neutral, the steel wire and insulated copper conductor are twisted together either by hand for smaller lengths (perhaps less than 10 m) or perhaps by using a modified twine winder for longer lengths. The copper winds over the steel because the steel is stiffer. Simply wrapping plastic insulating tape at both ends of the drop is adequate to keep the wires together.

The steel messenger is deadended at each end of the drop by passing it around the insulator, tensioning as much as possible by hand, and then wrapping the end of the steel wire around itself.

Table 13 provides the information necessary for voltage drop and power loss calculations.

**Table 13. Electrical specifications for copper and steel wire.**

Wire type/size	Diameter (mm)	Area (mm <sup>2</sup> )	Capacity (amperes)	Resistance (ohms/km)
Steel wire				
#14 AWG	1.62	2.06	1.3	92
#9 AWG	2.82	6.25	2.3	30
Copper wire				
#18 AWG	1.00	0.79	4	22
#16 AWG	1.29	1.31	8	14
#14 AWG	1.63	2.08	15	8.6

Note: The resistivity of standard annealed copper wire is 0.018 ohm-mm<sup>2</sup>/m while that of zinc-coated steel-core wire is 0.19 ohm-mm<sup>2</sup>/m. The resistance of a specific conductor is obtained by multiplying the appropriate figure just given by the length of the conductor and dividing it by its cross-sectional area.

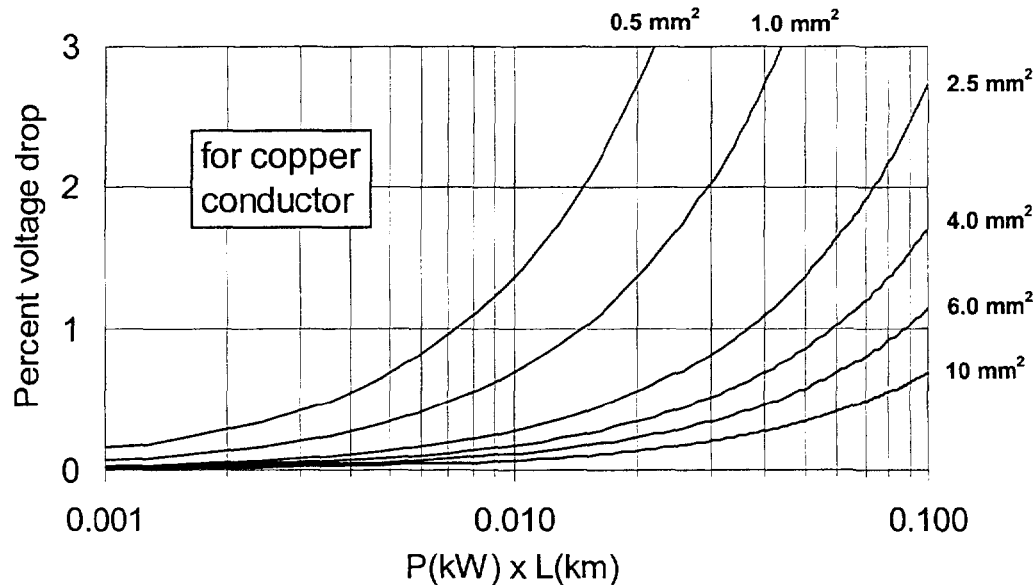


Fig. 101. A graph to calculate the voltage drop at the end of a copper 230-V single-phase service drop serving one or more homes. The area of the conductor associated with each curve is indicated at the top and right of the graph.

main distribution conductor (see Table 8, p. 75). However, if small conductors are used (i.e., less than about 10 mm<sup>2</sup>), the value of inductance  $x$  for the conductor is much smaller than its resistance  $r$  and the terms " $x \sin \phi$ " can therefore be neglected. The equation for voltage drop for a single-phase service, then simplifies to the following:

$$\text{Percent voltage drop} = \%VD \cong 2r \frac{P(\text{kW}) L(\text{km})}{E^2} \cdot 10^5$$

Note that, for these small conductor sizes, the solution to the simplified equation is independent of the power factor.\* To facilitate solving this equation for a service voltage of 230 V, the graph in Fig. 101 was prepared. To use this graph to size a specific service drop, sum the products of the peak coincident load in each home (in watts) along that drop and its distance from the beginning of that service drop (in meters). Look for this value on the horizontal axis and then move up to the point where the line for the desired percentage voltage drop is reached. The required size for a copper conductor is determined by the curve closest to that point. Multiply the area by 1.6 if an aluminum conductor is to be used.

As an example, assume that a home with a peak coincident demand of 200 W is located at 40 m from the beginning of the service drop and a second home with a peak demand of 400 W is located at the end of this 70 m service drop. The value of  $P \times L$  is  $(0.20)(0.040) + (0.40)(0.070)$  is 0.036 kW·km. Referring to the table or equation, a copper service drop of 2.5 mm<sup>2</sup> (or aluminum service drop of about 4.0 mm<sup>2</sup>) would be required for the voltage drop not to exceed about 1 %.

\* As can be seen from the equations for power loss (p. 75 and Table 8), power loss is dependent on the power factor. The power loss along service drops is inversely proportional to the square of the power factor. For example, doubling the power factor from 0.5 to 1.0 through power-factor correction reduces power loss in the line by a factor of four.

**Table 14. Minimum allowable size for various materials for service drops.**

Size for overhead in air*	Load (A)	Voltage drop (%)	Length of run (120 V service) (meters)	Length of run (230 V service) (meters)
Aluminum (5 mm <sup>2</sup> )	5	1	22	42
	5	2	43	83
	5	3	65	125
Copper (5 mm <sup>2</sup> )	5	1	35	67
	5	2	71	133
	5	3	104	200
Copper (0.8 mm <sup>2</sup> ) plus steel neutral messenger (2.0 mm <sup>2</sup> )	1	1	10	20
	1	2	21	40
	1	3	31	59

Service drops for most mini-grids tend to be limited to less than a 5-ampere demand per user. As noted earlier, because the current along a service drop is so small, it becomes the mechanical strength of the conductor rather than voltage drop that becomes the more important factor affecting conductor size, as was mentioned earlier. In addition to withstanding the tension in the conductor, the service drop conductor must have sufficient strength to prevent physical damage from falling tree limbs, the occasional abandoned set of shoes thrown over the line, or even people carrying long sections of bamboo poles. Over time, the action of the wind swaying the conductor back and forth can also work-harden the conductor, making it more brittle and susceptible to fatigue and breaking at the point it is fastened. For these reasons, while smaller conductor might be adequate electrically, some recommend a minimum diameter, such as 5 mm<sup>2</sup>, for a self-supporting copper conductor. Assuming the recommendation, Table 14 provides guidance for the maximum permissible length of service drops for different voltage drops using this diameter conductor. For comparative purpose, the characteristics of the hybrid conductor proposed in Box 8 have also been included.

### Connections

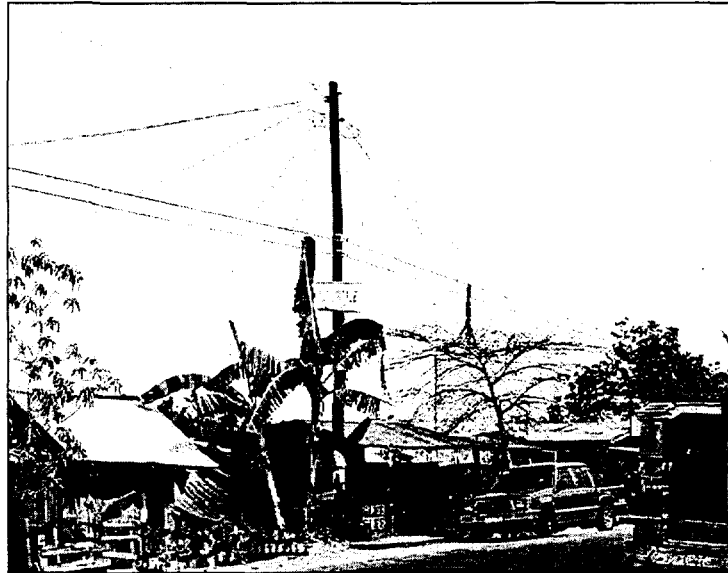
Service drop connections with the main low-voltage distribution line should preferably be made at the pole rather than along the span, because mid-span taps have only been used with limited success. They are the principal source of service drop failure where these are used without expensive attachment hardware, because the service drop is subject to wind-initiated motion and metal fatigue at the unsupported joint. Once the conductor has been strung, it also becomes more difficult to make a mid-span connection or disconnection.

When consumers are densely grouped, several configurations are possible. One is to connect each consumer to the main line in a maypole arrangement (Fig. 102). This requires more conductor but minimizes the voltage drop along the service drop and makes each consumer independent of the others. Another option is to run the service drop from consumer to consumer (Fig. 103). This requires less conductor but increases the voltage drop along the line and possibly reduces the quality of power for the

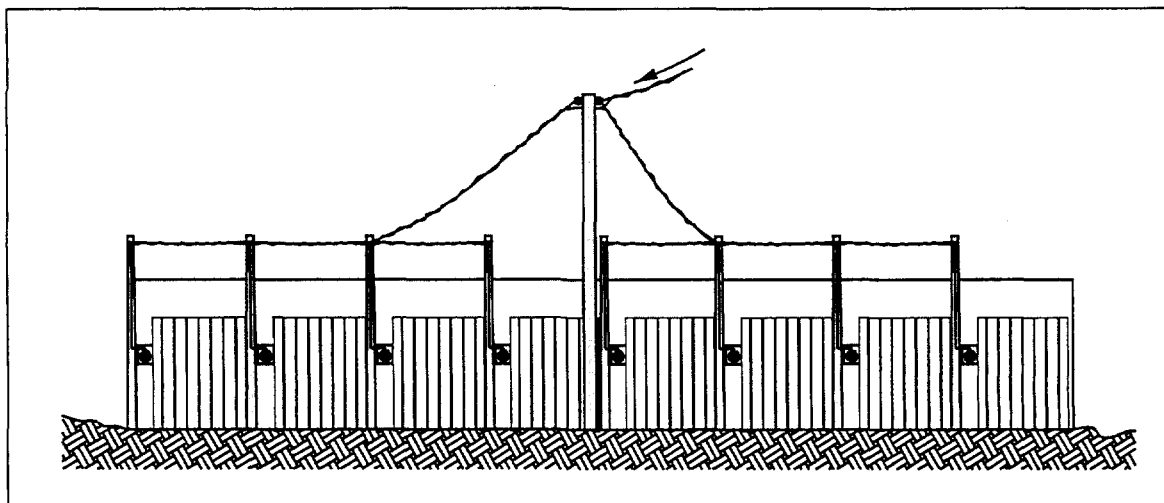
remoter consumers. If an intermediate consumer is disconnected for whatever reason, it makes it easier for that consumer to steal power since the line still runs "though" his premises.

Both ends of a service drop which does not use multiplex should usually be deadended on smooth-faced insulators or other hardware specifically provided to insure a solid support (Fig. 104). However, if a multiplex conductor is used, then only the messenger conductor needs to be deadended, because the other conductors, which are wrapped around the messenger, are supported by the messenger conductor. In both of these cases, the conductors are mechanically secured. These approaches remove any strain that might otherwise be placed on the electrical connection by the tension in the conductor and minimize any adverse effect the movement of the conductor caused by wind might have on the connection. In short, it reduces the possibility that the integrity of the electrical circuit is placed in jeopardy. This practice is more critical for village grid designs because the conductor size is usually small and of limited strength.

For solid insulated conductors less than  $25 \text{ mm}^2$  (or #4 AWG), wrapped deadends as illustrated in Fig. 105 are common practice for service drop installations. The conductor is tensioned to hand strength by the installer without the use of mechanical tensioning devices. The conductor is deadended at one end and then drawn up and deadended at the other end and simply wrapped several times, leaving enough of a



**Fig. 102. Maypole arrangement for service drops supplying a dense grouping of homes in Davao in the Philippines.**



**Fig. 103. An arrangement used in Bangladesh to serve a row of stores in a bazaar. Feeding the center of each section of service drop reduces the voltage drop along this line.**



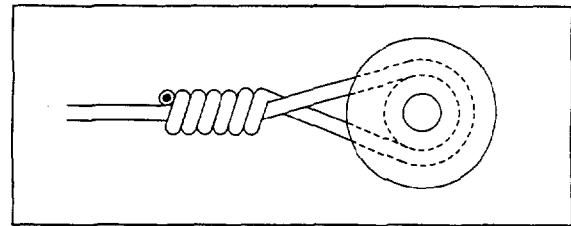
**Fig. 104. The service drop fixed to the eave of the roof with wireholders.**

wire, the individual strands displace unequally due to the sharp bends and may damage adjacent strands or the insulation. Therefore, stranded conductors are best deadended with hardware such as preformed wire deadends, wedge clamp deadends, and parallel groove clamps (see Chapter IX). Care must be exercised to ensure that clamps are properly tightened to prevent the deadend from failing. If clamps such as parallel groove or U-bolt clamps rely on nuts and bolts that have to be tightened, two wrenches should be used. One wrench should be used on the nut while the other is used to hold the bolt head to ensure that these two are tightened against each other.

Once the service drop has been mechanically secured at either end, electrical connections must be made to the distribution line at one end and to the conductor used at the service entrance at the other. The two basic ways of making a good connection are by using a connector or by soldering. The first approach is quicker but requires the necessary connectors, clamps, wrenches, and crimping tools. The second only requires a simple skinning knife, pliers, and soldering iron but can only be used for copper-to-copper connections (Fig. 106) and is more time consuming.

These approaches are covered in Chapter IX. As mentioned there, twisted connection should be avoided, except in the case of connecting copper conductor where the connection can be soldered. Also, copper/aluminum connections can be a source of problems due to oxidation and corrosion, and care must be taken with these connections. Once completed, all connections should be taped with electrical tape.

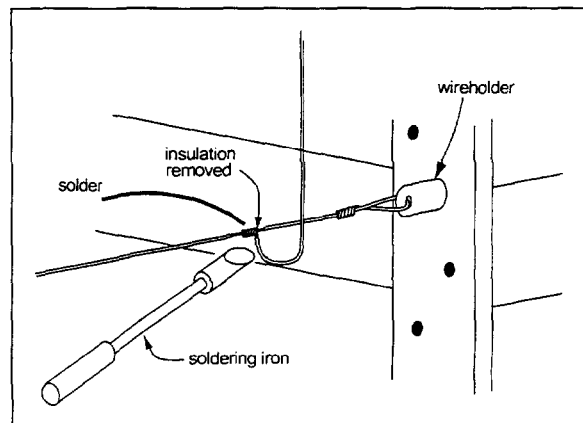
Figure 107 illustrates a connection between a duplex aluminum conductor used as a service drop and the cable entering the consumer premises. In this case, a preformed deadend is used to connect the service drop to the residence. An uninsulated connector is used to connect the neutral conductors while an insulated connector is used to connect the live conductor. A drip loop follows each



**Fig. 105. A wrapped deadend for a service drop using a solid insulated copper.**

tail at each end to connect to the distribution line and the consumer's service entrance.

For stranded uninsulated or insulated conductors, mechanical deadending devices designed for this particular application should be used. If a wrapped deadend is attempted with stranded



**Fig. 106. Soldering a twisted copper-to-copper connection.**

connection to lead any water away from the connectors.

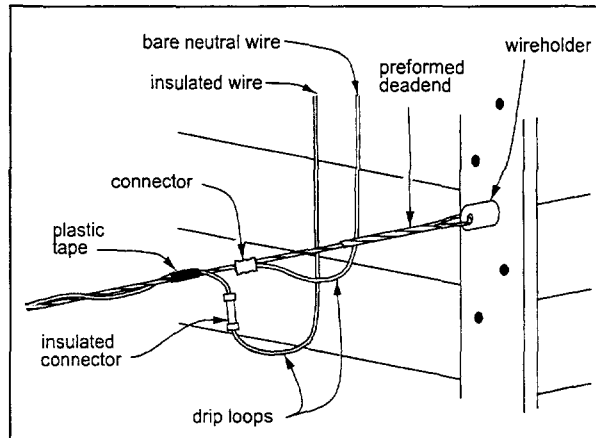
If ABC conductor is used for the service drop, Fig. 108 illustrates how this cable is usually deadended on a distribution pole. In this case, a single-phase line passes from the lower left to the upper right and the insulated neutral conductor is supported by a suspension clamp. One compression clamp on the distribution line (lower left) connects the phase conductor to each of the three service drops, while the clamp next to it connects the neutral to the drops. The compression clamp on the upper right is used to connect the distribution line neutral to the grounded steel distribution pole.

Figure 109 illustrates how a wedge clamp is used to deadend the other end of a service drop to a home build of concrete. The cable passes through conduit to prevent damage to its insulation that might occur by rubbing against the concrete.

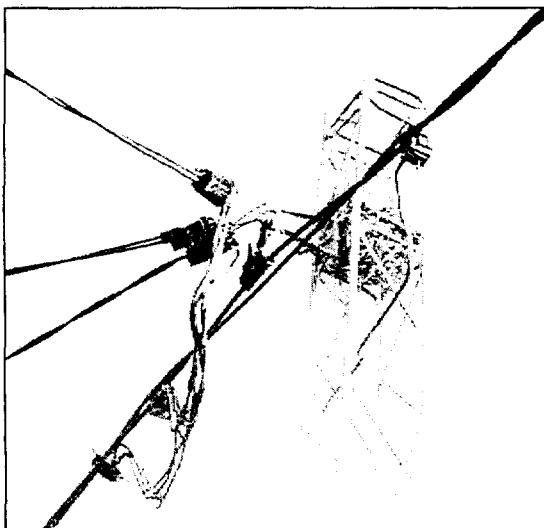
### Service entrance

The service entrance serves the function of connecting the consumer (the housewiring) to the electric utility (the service drop) and, usually, includes a mechanism for monitoring and/or controlling the power (kW) or energy (kWh) used.

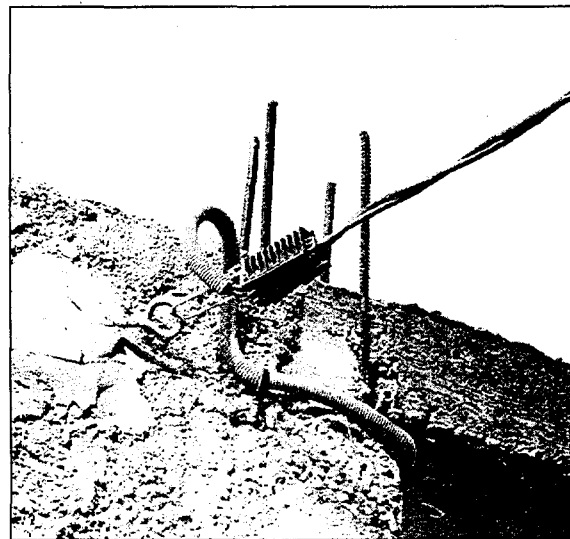
In all cases where an overhead service drop is used, the service entrance brings the electricity from the service drop which is normally at an elevation unreachable by a person down to a height that can be



**Fig. 107. A connection between a duplex service conductor and the residence.**



**Fig. 108. Wedge clamps deadending service drops on a fabricated metal distribution pole in Tunisia.**



**Fig. 109. A wedge clamp deadending a service drop found in a concrete home in the Tunisia.**

touched by an adult. Therefore, it is important that the service entrance provide adequate protection against electrical shocks for the general population. The service entrance should provide sufficient mechanical protection for the conductor so that an object rubbing or striking the service entrance will not damage the conductors or cause a short circuit. At times, a metal service mast, possibly extending above the roof, leads the conductor down the outside of the home. At other times, a heavy shielded cable is used and fastened to the dwelling with large staples. And in simple mini-grids, the service entrance may be no more than simply a pair of insulated single wires passing through the wall of the customer's premises to a junction box or distribution board located inside the residence.

More typically, the conductor coming down from the service drop leads to an enclosure that houses either an energy meter (the conventional approach, see "Conventional metering", p. 154) or a power- or current-limiting device (more typically used by smaller mini-grids, see p.155). An energy meter should generally be located 1.7 to 2.0 meters above ground level so that it can be easily read and high enough to keep it beyond the reach of small children. And it should preferably be mounted on the outside of the house before bringing the line indoors. If a current-limiting device is used, it might be located somewhat higher as there is no need to read it.

The enclosure should be locked or sealed to deter tampering. Provision should be made for access to the switch on the MCB to allow resetting, if such is used. The enclosure must be fully water-proof and fixed to a structurally sound, permanent part of the building or a purpose-built support. Cable entries should be from the bottom only, with a drip loop to prevent water entering the unit from these openings.

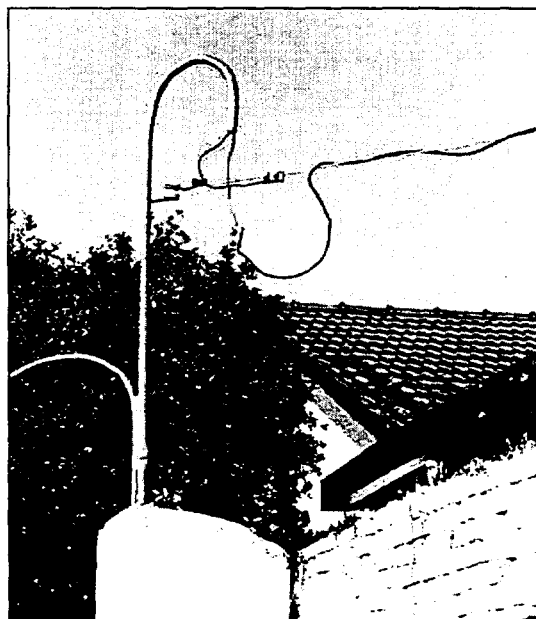
Ideally, the enclosure should be outside the house or business premises. In a number of countries, meters are mounted inside the home. The rationale is that the consumer often purchases the meter and keeps it indoors to protect it from vandalism. However, the reality is that the indoor location often frustrates those responsible for reading the meter when the consumers are habitually "not home". It also makes it easier to tamper with the meter to make it understate the actual energy used. If meters are used with a mini-grid and if that system is to be effectively managed to the benefit of all the consumers, they should be mounted outdoors.

In some countries, families may be living in temporary quarters on their property until they earn sufficient money to build a more permanent home elsewhere on the property. In these cases, the service entrance may be located with a brick masonry structure, usually near the front of the property, that includes the meter or current-limiting device (Fig. 110). Other conductors then lead from there to the temporary structure.

## Metering

An electricity distribution system supplies a service to consumers, and for this reason, some means must be incorporated within the system to assess what the consumers owe to cover the costs incurred in providing this service. This is one function of metering.

Conventionally, this is done by using an energy or kilowatt-hour meter, which measures the electrical



**Fig. 110. Service drop to a masonry structure in the yard is commonly seen in Bolivia.**



energy used by the consumer and is included as part of the service entrance. A meter reader then periodically records meter readings and the energy consumed each month is calculated. The utility then uses this to prepare the consumers' bills. These should be based on a tariff schedule designed to generate the necessary revenue to cover all costs incurred in delivering this service (see p. 178).

But mini-grids serving rural areas face additional constraints:

- The mini-grid is supplied by a powerplant of limited capacity. Consequently, the metering function may also have to provide some control over the power consumption by each consumer to ensure the equitable availability of electricity to all consumers. Energy meters alone cannot address this issue.
- While electricity is seen as an important commodity, the amount that many households can spend on electricity is limited. If energy meters were used, simply the cost of the meter, meter reading, bill preparation, and collection for each household would exceed the cost of supplying the electricity consumed. It also would involve more sophisticated bookkeeping.

Rather than billing on the basis of energy consumed, a less costly and more equitable form of "metering" involves setting a tariff based on the power consumed by each household. A consumer's bill might then be calculated either on the basis of connected load (e.g., a household is permitted up to the use of two fluorescent lamps and one TV) or on the basis of a subscribed maximum power input (e.g., a household can use up to 40 W).

In summary, the option for metering in a specific situation depends on a number of factors, including the capacity of the power plant, the number of consumers, the cost of energy, the ability and willingness of consumers to pay, the desire to benefit as many of the households as reasonably possible, and the institutional mechanism to operate and manage the system. Below, the technical options for "metering" are reviewed. The section "Options for tariff schedules" in Chapter XIV describes the advantages and disadvantages associated with each of these options and should be reviewed before adopting any of the technical options described below.

### ***Conventional metering***

If a mini-grid uses the conventional approach—relying on energy meters—for metering, this is usually because no other alternatives are either known or considered. While this approach has advantages for national-grid-connected systems, it presents a variety of drawbacks when used with mini-grids, the most significant being cost and the inability to ensure equitable use of the capacity of small power systems.

The typical energy meter is an electro-mechanical or electronic device that is part of the service entrance, preferably placed outside the home to facilitate meter reading but occasionally found inside. Two options exist for the connection of energy meters: the bottom-connected meters and the socket-connected meters.

If a bottom-connected meter (Fig. 111) is to be installed, the entrance cable should have extra sheathing to protect the conductors leading to the distribution board and be sealed at the meter's entrance. Open-base meters should not be used because the exposed terminals present a high level of danger to people, especially to curious prying little fingers, and encourages tampering. Some bottom-connected meters do not have bi-metallic connections required for copper conductors. Before installing the service entrance, verify the type of wire that is compatible with the meter.

If a socket-connected meter is to be installed, suitable conduit is provided to protect the conductors from the service drop to the meter. This installation provides for the most security for both the utility and the

consumer, but its initial cost is higher. There are many operational advantages to a socket meter installation, but unless the country is already using socket meters, they most likely will not be introduced for mini-grid applications.

### **Alternative "metering": load limiters**

The second basic approach to "metering" is to limit the current to a predetermined and agreed upon level and to pay on the basis of this level. In its simplest sense, this limit can be based on a verbal agreement. A household would simply notify the system manager that it will limit its consumption to, for example, two 40-W bulbs and pay \$1 per month for that service. The only factors ensuring that these terms are abided by are either the family's honesty or its fear that it will be penalized when someone somehow finds out that it is using a couple of 60 W bulbs. While this is the cheapest approach, it will probably only work for some small systems where there is a good understanding between all members of a community. It will also work when there is plenty of excess capacity in both the supply and distribution system, but additional costs will be incurred by the system owner for the extra energy generated and consumed.

In larger communities, suspicions that one or more households are exceeding their entitlement can easily arise, and a natural reaction is for some of the other households to start exceeding their quota rather than to confront the possible offender(s). This will lead to overloading the system and to a subsequent reduction in consumer voltage. This can then lead to the use of higher wattage light bulbs to try to offset the reduction in light due to the lower voltage. By the time the situation becomes so bad that the community meets to try to solve the problem, the culture of suspicion and over-consumption will often have become too endemic for consumption level to be effectively regulated by verbal agreement.

But to avoid problems that may well arise, several technical solutions are available. These all rely on load limiters, which are simply overcurrent cutout devices. If the consumer draws a current higher than that to which he or she has subscribed, the cutout will operate and disconnect the supply. Some load limiters have to be reset manually while others reset automatically. The consumer pays a fixed monthly fee according to the rating of his load limiter, irrespective of the kilowatt-hour consumption (Fig. 112).

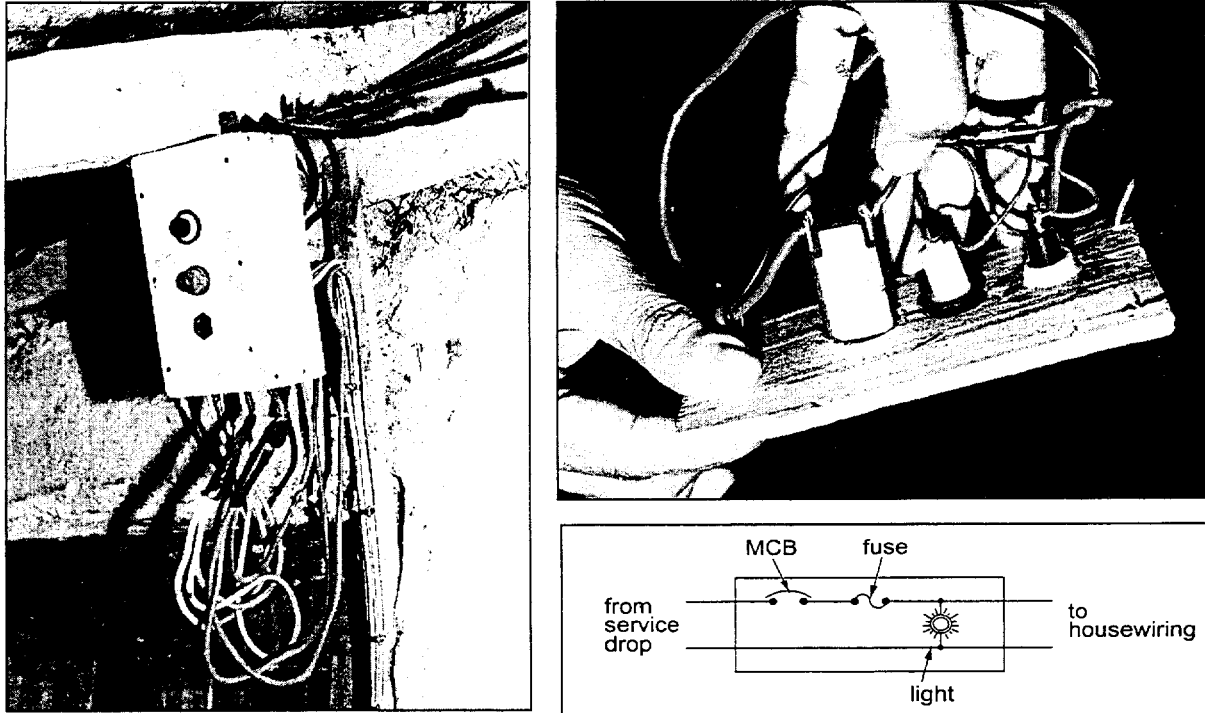
Table 15 reviews the characteristics of five possible current cut-out devices.

### **Fuses**

Using fuses may be the most obvious and cheapest approach to limiting a current into a consumer's home and they are widely available. However, they are not a good option for several reasons. They are not accurate. They age when operated at close to their rated current and will fail in time, even if the rated current is not exceeded. More annoying to the consumer is the fact that they cannot be reset; a fuse needs to be replaced each time it blows. It must be accessible for replacement because this may happen



**Fig. 111. View of a bottom-connected meter.**



**Fig. 112.** This homemade current limiter box is mounted outside the home at the end of the service drop. It is comprised of a low-current MCB, a fuse, and a light indicating when the supply is activated.

frequently. And if a replacement fuse is not available, the consumer with a little initiative can easily replace it with whatever wire is available, completely negating the purpose of the fuses both to limit current flow as well as to protect the home against the effects of a short. This last drawback can be protected against by placing the fuse in a sealed box, accessible only to the system operator. But waiting for the operator to replace the fuse will also be frustrating to consumers (although it may make them think twice the next time they consider exceeding their agreed-to limit). If fuses are used, time-delay or slow-blow designs should be used because they will let through small surge currents without blowing, although

**Table 15. Characteristics of a variety of current cut-off devices.**

Attributes	Fuse	Thermal miniature circuit breaker	Magnetic miniature circuit breaker	Thermistor	Electronic circuit breaker
Reset mechanism	Replace	Manual	Manual	Auto	Auto
Accuracy	Poor	Poor	Medium	Very Poor	Medium-Good
Short-circuit proof	Type dependent	Type dependant	Type dependant	No	Type dependant
Min. current (A)	0.04	0.05 A	0.05 A	0.01 A	0.05 A
Max. current (A)	> 50 A	>50 A	>50 A	0.7 A	5 A
Availability	Good	Good for > 6 A	Limited	Limited	Very limited
Price	Low	Low-Medium	Medium	Low	Medium-High

they too may age with time.

### **Miniature circuit breakers (MCBs)**

While somewhat more expensive, circuit breakers are more accurate than fuses and have the advantage that they can be reset without replacement. As with any device used to monitor or control electricity consumption, it is open to tampering by the owner of the residence. Placing the device indoors encourage tampering as this can be done in privacy. A partial solution to this is to always locate the device in a location outside the home, suitably protected from the elements. The device should be enclosed in a box with restricted access. Box 9 describes MCBs used as “metering” devices by a national utility in a more conventional setting in urban areas of Zimbabwe.

### **PTC thermistors**

While miniature circuit breakers are available down to 0.01 A, they are relatively costly. Positive temperature coefficient (PTC) thermistors have been used as low-cost alternatives. This solid-state device, resembling a coin soldered between two conductors, is placed in series with the incoming current. If current exceeds its rated value, the device heats up and, at a certain temperature, suddenly presents a high resistance, effectively stopping the flow of any further current. The devices “resets” automatically when the overload is disconnected and the thermistor is permitted to cool down. Waiting several minutes until the thermistor cools down, permitting current to flow once more, could again be frustrating to the consumer who has to wait in the dark.

Thermistors must be protected from larger currents associated with a short that might occur within the residence. To protect the thermistor, a fuse rated above the rating of the thermistor must be placed in series.

To prevent tampering, the thermistor and fuse should be located in a sealed box. However, should the fuse blow because of significantly excessive current draw, the consumer would encounter the same level of frustration as found with using a fuse alone in a sealed box, that is, waiting for the operator to come replace the fuse. To address this issue, two fuses are sometimes used, one with a lower rating outside the sealed box which can be replaced by the consumer and one inside that is larger but still adequate to protect the thermistor. In this manner, failure of the consumer to correctly replace the fuse will mean that the next time excessive current is drawn, the fuse inside the sealed box will blow, revealing his improprieties.

PTC thermistors are only available in sizes up to about 0.7 A (equivalent to a power demand of 160 W at 230 V). It should be noted that thermistors are triggered by current (A) and not power consumption (W). As was noted earlier (p. 32), uncorrected fluorescent lamps make inefficient use of current. For example, a capacitor-corrected fluorescent lamp operating at 23 W would draw a current of 0.10 A at 230 V. However, a fluorescent lamp operating at 23 W without capacitor correction and with a power factor of 0.5 would draw 0.20 A. This is twice the current draw for the same amount of lighting. Therefore, if two consumers pay the same tariff and both have thermistors set to cut off at 0.4 A, the consumer with uncorrected fluorescents could operate about 2 lamps while his or her next door neighbor with corrected fluorescents could operate about 4 lamps.

Both PTC thermistors as well as thermal MCBs have been used in projects in Nepal. Box 10 describes briefly experiences in that country.

### Box 9. Load-limited supplies in urban Zimbabwe.

Load-limited domestic supplies have even been used by more conventional electric utilities. In Zimbabwe, for example, MCB-type load limiters have been extensively used since the 1960s. In 1996, 129,000 consumers had load-limited supplies, compared to 210,000 consumers with metered supplies. The vast majority of these consumers were in urban areas. There are eight categories of supply, ranging from 1 to 30 amperes. However, the categories above 7.5 amps are no longer provided to new customers, as it is considered that these consumers can afford a metered connection and that their higher consumption makes metering worthwhile.

The typical cost to the supply authority, ZESA, for providing a load-limited service connection is US\$ 50 compared to US\$ 100 for a metered supply. The load-limited households save on housewiring costs, because some components, as an additional enclosure for fuses or circuit breakers, are not mandatory.

Table 16 presents tariff and customer data for the different load-limited supply categories. The tariff for metered customers consists of a fixed monthly charge of \$1.90 and energy charges of \$0.019/kWh for the first 300 kWh and \$0.045 for the balance. Since the fixed monthly charge for a metered supply is the same as the total monthly charge for a 1 amp load limit, it is clear to the consumer that the load limiter is the cheaper option for this consumption level.

While one might suspect that load-limited consumers might squander energy available to them, measurements have shown that, for load-limited supplies in the range 1 to 7.5 amperes, load factors are within the range 24 to 29%. These are not excessive. The consumers are provided with leaflets on how to use the load-limited supply.

Load-limited customers pay for their electricity in advance, each month, at the local electricity board office. No bills are sent to the customers. If the tariff is not paid, then the supply is disconnected within two weeks. Metered consumers have their meter read every month and are presented with a bill a few days after the reading date.

The main problem that ZESA has faced with its load-limited supplies is the theft of electricity. A recent fraud was the replacement of 5-amp load limiters with 15-amp load limiters, with the consumer erasing the number 1 in the front! Utility staff have also been found to be involved in this fraudulent activity. They have been known to make arrangements with consumers for upgrading load limiters. The consumers then pay the original tariff plus a secret payment to the staff member. These frauds are detected by regular checks at the consumer installation, using staff from other districts. Incorrect load-limiter ratings are detected by connecting a 3 kW load after each load limiter and checking that the load limiter operates. However, this is very time consuming.

Damage to MCBs is quite common and is often done by the consumer repeatedly attempting to reset the device without first clearing the overload. An annual failure rate of 9% was found in Chitungwiza township, compared to less than 0.2% for electricity meters.

**Table 16. Approximate consumer distribution by to tariff category (1996).**

Limiter (amps)	Monthly cost (US\$)	Number of customers*
1.0	1.90	2,400
2.5	2.90	5,700
5.0	4.50	27,000
7.5	7.50	49,900
10.0	13.60	1,800
15.0	19.10	13,900
22.5	22.60	1,100
30.0	32.60	122

\*Information based on data from most but not all area offices.

**Box 10. Load-limited supplies in rural Nepal.**

In Nepal, load limiters have been used on rural electrification projects since the 1980s. They were first used on stand-alone micro-hydropower projects. Load limiters are particularly appropriate for these projects because marginal operating costs are minimal; the cost of operating the plant is largely independent of how much of its capacity is used. PTC thermistors and thermal MCBs are used and have generally been found to be reliable. Most connections are of 100 W (0.5 amps) or less.

In 1989, load limiters were installed at the Andhi Khola electrification project, a 5-MW scheme that supplies electricity to the local area and sells excess power to the grid. Rural and semi-urban consumers are supplied and more than 95% of households have a connection. Initially there were three load limiter options: 25 W, 50 W and 250 W, with the 250 W option being designed to enable consumers to use a low wattage cooker that was promoted by the project. A 100 W option has been recently introduced.

It is clear from Table 17 that, before the 100 W option was available, rural consumers generally subscribed to the 50-W load-limited supply, whereas the semi-urban consumers tended to have a 250-W load limiter or meter. The monthly cost for the load-limited supplies are \$0.34 for 25 W, \$0.70 for 50 W, and \$1.90 for 250 W. The average monthly consumption of the metered consumers is 87 kWh at a cost of \$3.70 (1994).<sup>15</sup>

**Table 17. Distribution of consumers according to type and tariff category.**

Classification of consumer	Load limited consumer			Metered consumer	Total consumers
	25W	50W	250W		
Rural	19	127	40	0	186
Semi-urban	2	59	171	83	315

Each rural community served by a load-limited supply is organized in a users' group, and one member from each group is employed as a service person to collect the tariff and carry out basic repair and maintenance work. Because every household has a load limiter rather than a meter, the monthly fees are fixed. This is advantageous for the electricity company and the service person, since both know the amounts of money due from each consumer. The service person is then responsible for collecting monthly fees and for periodically depositing a predetermined sum into the local bank account of the electric utility.

**Electronic circuit breakers (ECBs)**

Electronic circuit breakers use a semiconductor device, such as a triac or transistor, to disconnect the supply in the event of excessive current. The current is often measured in terms of a voltage drop across a low resistance. Additional circuitry is used to provide time delays that prevent disconnection due to surge currents and to automatically reconnect the supply. ECBs have been designed specifically as load limiters and are available from specialist suppliers. Their typical cost is \$15, which is higher than for most other types of load limiters but can often be justified as a result of better accuracy and their auto-reset facility (as illustrated in Box 11).

Electronic circuit breakers are a fairly recent development, and it is important to check that the products are reliable, either by obtaining samples for evaluation or through recommendation from other users.

**Box 11. Cost vs. accuracy for alternative load-limiter options.**

For this example, consider the case of a micro-hydropower scheme for a village with one hundred households, where each household is to be supplied with a 1-amp load-limited supply with a rated voltage of 230 V, enough for four light bulbs or three light bulbs and a small black and white TV. The ambient temperature extremes at this village varies between 10 °C in the evening of the cooler season and a 40 °C peak during the day in the warm season.

Two types of load limiters are available for this comparison, a thermal miniature circuit breaker and an electronic circuit breaker. The price of the MCB is \$5 and the ECB \$15. The cost of the micro-hydropower scheme is \$2,000 per kilowatt.

The characteristics of the MCB are such that at 45 °C the tripping current is between 1.00 and 1.35 A. However, when ambient temperatures decrease to 15 °C, this range increases to between 1.15 and 1.55 A, as more heating is required from the current to compensate for the lower ambient temperature. In this latter case, a greater power output will be required from the micro-hydropower plant. To prevent overloading and a consequent reduction in supply voltage, the scheme must be designed to supply this higher current.

The characteristics of the ECB are such that the tripping current is between 1 and 1.2 A, irrespective of the ambient temperature.

Since 100 load limiters will be used, it is acceptable to assume average values from the tripping current range, i.e., 1.35 A for the MCB and 1.1 A for the ECB.

The maximum apparent power consumption  $P(\text{VA})$  in the village when either only PTCs and only ECBs are used, respectively, would be the following:

$$P_{MCB} = 100 \times 230 \text{ V} \times 1.35 \text{ A} = 31,000 \text{ VA} = 31.0 \text{ kVA}$$

$$P_{ECB} = 100 \times 230 \text{ V} \times 1.10 \text{ A} = 25,300 \text{ VA} = 25.3 \text{ kVA}$$

The actual power requirement must take into account the power factor of the load and the fact that the consumers will not all be using their maximum entitlement at the same time. The reduction will depend on usage patterns in the community and types of load and should be determined by a pre-installation

*(Continued next page)*

Two organizations involved with electronic circuit breakers are Development Consulting Services in Nepal and Sustainable Control Systems Ltd. in the UK.<sup>16</sup>

In deciding what type of load limiter might be used, the following factors should be considered:

- Likelihood of fraud and theft: Where the likelihood of the consumer trying to obtain free electricity by bypassing the load limiter is low, manually reset circuit breakers are an acceptable choice. These must be accessible to the consumer for resetting. If protection against bypassing is required, the load limiter must be auto-resetting and fully sealed against the ingress of moisture so that it can be mounted on a distribution or service connection pole. This makes it harder for the consumer to bypass the load limiter and easier for detection, because any bypassing should be clearly visible.

(Continued)

survey and comparisons with existing projects. In this case, it is assumed that most households will be using close to their rated power in the evenings for lighting and TVs. The estimate for the maximum actual power consumption is taken to be 0.8 times the maximum theoretical power consumption. An additional factor, for power loss in the distribution system must also be included, and is assumed to be 1.1 in this case.

Hence the power required from the micro-hydropower plant under each scenario is:

$$P_{MCB} = 0.8 \times 1.1 \times 31.0 \text{ kVA} = 27.3 \text{ kW}$$

$$P_{ECB} = 0.8 \times 1.1 \times 25.3 \text{ kVA} = 22.3 \text{ kW}$$

The cost of the scheme with the MCBs is:

Micro-hydropower scheme	27.3kW @ \$2,000 per kW	\$54,600
MCBs	100 units @ \$5	<u>\$ 500</u>
	Total	\$55,100

The cost of the scheme with the ECBs is:

Micro-hydropower scheme	22.3kW @ \$2,000 per kW	\$44,600
ECBs	100 units @ \$15	<u>\$ 1,500</u>
	Total	\$46,100

It is clear that, in this case, use of the more costly ECBs would be justified because the savings in the cost of the micro-hydropower scheme would be ten times greater than the extra cost of the load limiters.

In the case of a diesel powered system, the initial savings are likely to be less due to lower equipment costs. However, with diesel generation, there will be additional savings in fuel costs as less power would need to be generated. A similar analysis can be done in this case.

The financial argument for using accurate load limiters will be greater for higher-current connections as fewer load limiters would be required for the same generating capacity.

- **Cost against accuracy:** It is tempting for service providers to install cheap load limiters in order to reduce costs. However, if the cheap limiters have poor accuracy, the overall cost may be higher because a greater power capacity will be required and energy usage will be greater. This is illustrated in Box 11. The minimum and maximum tripping currents for load limiters must be studied in order to ensure that the consumers will always receive the current for which they have subscribed and to determine the most cost-effective option. Variations in tripping current with temperature must be taken into account, for the full temperature range that can occur where the limiter is located. In addition to the cost disadvantages of load limiters with poor accuracy, customer complaints are likely to be higher, because some customers may be unable to run as many appliances from a load limiter of the same current rating as their neighbors.



## Housewiring

Land tenure practices in a specific country can have a considerable impact on the price households are willing to pay for accessing electric service. If a home is part of a squatter settlement where families do not own the land, they probably have limited financial resources and, in any case, are probably not willing to spend much for electrifying their home if, from one day to the next, they may have to move. Or if it is clear that the mini-grid is a stop-gap measure until the national grid arrives in several years and the distribution system will then have to be rebuilt, they may also not be willing to sink too much into a temporary scheme even if their homes are permanent. In these cases, there may be an argument to use low-quality and therefore less costly materials, as long as they are safe.

Minimum building standards, such as a requirement for a water-tight roof, are often imposed on the grounds of safety. In some countries, traditional dwellings with thatched roofs are not allowed to have grid-supplied electricity. However, it is also important to recognize that, if households do not have electricity, they would use kerosene and candles that could also result in considerable safety risks. This is therefore a strong argument that electricity should even be available to traditional dwellings.

On the other hand, if potential consumers have ownership of their land, they are usually more willing to make a larger financial commitment. In this case, the question of the quality of the materials and workmanship used for housewiring and, inevitably, its cost are often a point of discussion. Low-cost (and lower quality) materials clearly make electrification more affordable at the outset. However, one has to be cautious because these families are apt to remain in a home for a long time. If low-quality materials are used, switches and outlets are bound to eventually fail. Most will then resort to makeshift solutions—sticking wires into outlets or making switches by hooking bare wires together. Therefore, from the point of view of the life-cycle cost of the installation, personal safety, and consumer satisfaction, one should lean toward the higher-quality solution, even at the expense of somewhat additional cost.

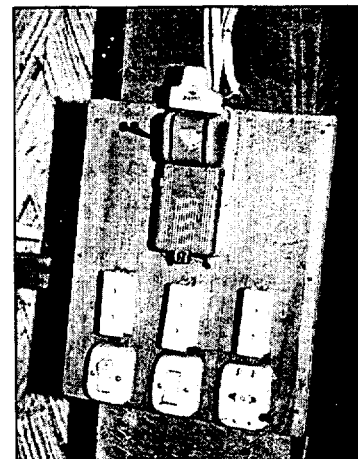
Housewiring originates at the service entrance, conveys power to the distribution board usually located on a wall in the house, and then distributes it to the various lighting fixtures and power outlets in and around the home. In a village setting, a distribution board might look like that shown in Fig. 113. In this case, it is a plywood base with a frame 1 to 2 cm high around the back that raises this base above the mounting surface and leaves space for the wiring. In industrialized countries, a distribution board would generally take the form of a steel box, with door.

Rather than selecting from a range of electrical components that might be mounted on such a board, it is wiser to decide what protection and control features should be part of the consumer's supply and then to select those components which permit accessing these features.

For the most basic system, a distribution board may not even be needed. In this case, power would be delivered to a light in each home. With the arrival of nightfall, the genset is started, lighting the lights. Several hours later, the system is shut down. No light switches, fuses, breakers, knife switches, MCBs, etc., would be required.

However, most consumers are somewhat more demanding and require

**Fig. 113. One design for a distribution board, which includes a knife switch, a fuse and a switch for each of two lighting circuits, and a fuse with the power outlet.**



features that give them more flexibility. Below are explained the various components which might be included as part of the distribution board and circumstances under which each would be included:

- **Light switches.** These are required if the consumer wishes some control over which lights are to be lit and when. This is usually the case. In more sophisticated systems, these light switches are placed at the entrance to the room in which the light is found. However, in more rural settings, the home is small and the switches are centrally located, often on the distribution board itself.
- **Power outlets.** If the generator can supply adequate power and if the mini-grid has adequate capacity to distribute this power without increasing the voltage drop beyond an acceptable value, consumers may wish to make use of other electrical devices or appliances. These can range from a TV and/or radio to motor-driven equipment to a wide range of other equipment usually available on local markets. But power outlets should not be included if generating or distribution capacity is inadequate, because the mere presence of outlets will tempt the consumer to go out to purchase these appliances.

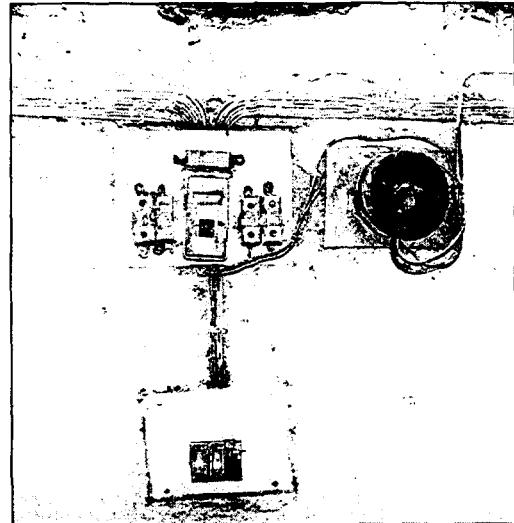
Furthermore, if power outlets are included, an MCB or fuse must be included to have some control over the maximum additional power that the consumer may use.

- **MCBs.** This can serve several functions:
  - It would also serve to protect the housewiring from overcurrents and shorts.
  - It can be used as an occasional on-off switch, to isolate the home from the supply when, for example, modifications or repairs have to be made to the existing housewiring. With systems that are only on for several hours in the evening, this is not critical because repairs or modifications can be made when the system is off.
  - It can be used as a current limiter (see below) in situations where the consumer is billed according to his or her maximum power demand set by the MCB.

MCBs have the advantage over fuses in that they are resettable, more precise, and less open to tampering. They are, however, more expensive.

The MCBs should be located immediately at the entrance to the distribution board, before any other components, irrespective of what other components are included on this board.

- **Current limiter.** If the tariff schedule requires the use of a current limiter, a MCB (above) might serve that purpose, in addition to several other purposes already mentioned above. Other lower-cost or more readily available alternatives are possible (p. 155). These could also be mounted as part of the distribution board (Fig. 114).
- **Knife switch.** If fuses are used to protect the circuit for overcurrent, a knife switch would be used to isolate the household circuit from the supply in an emergency situation or if repairs are



**Fig. 114.** The distribution board for a rural home in Nepal. The service drop to the home enters from the right and passes through a Norwegian current limiter and the main breaker with fuses.

required on the household circuit. When knife switches include built-in wire fuses, these can serve as overcurrent protection. However, because fuse wire of the proper size will usually be difficult to find locally, fuses with the incorrect rating will likely be used, placing the system in jeopardy. This is another reason MCBs are preferred to fuses.

- **Fuses.** Fuses are commonly included on each circuit, as can be seen in Fig. 113 (p. 162) where the two lighting circuits and the power outlet each have a fuse. This is not required, because fusing the main incoming line with a fuse of proper size would be adequate. If a properly sized MCB had been included in the incoming circuit, individual fuses would have been an unnecessary expense because they provide no additional protection.

With a pair of ungrounded, single-phase lines entering the consumer's premise, one line would need to be fused to protect the incoming circuit. However, under a fault condition, this fuse would blow, leaving the other line energized. This would create a potentially hazardous situation for anyone who might try repairing the circuit on the load side of the fuses. A knife switch should be used in the incoming lines in this situation.

With a pair of ungrounded, single-phase lines entering the consumer's premise, both lines are sometimes fused. This might be the case if no knife switch precedes the fuses. This is because, under a fault condition, the likelihood is that only one fuse will blow, leaving the other line live. This would create a potentially hazardous situation for anyone who might try repairing the circuit on the load side of the fuses. If no knife switch has been included, care must therefore be exercised to ensure that both fuses are temporarily removed before work on that circuit is undertaken. Use of a knife switch would be preferred as safer and only one line would need to be fused.

- **RCD.** For consumers with more varied and sophisticated end-uses, where there is greater chance of shock to individuals, incorporating an RCD is one means of ensuring a safe environment. While it might be suggested that safety requires the installation of an RCD in each residence, they are relatively costly and are not necessary if the end-uses are restricted to lighting and entertainment.

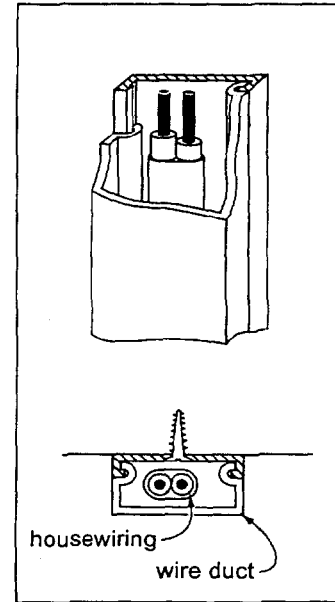
If used, the RCD should be located immediately after the MCB (so that the MCB can be opened as a protective measure if work on the RCD is required) and before any fuses (to permit the RCD to trip if the fuses are touched or being replaced while the household circuit is still accidentally energized).

- **Ballasts.** For households relying on fluorescent lighting, ballasts are required. Although the larger, more sophisticated fluorescent units include the lamp, starter, ballast, and fixture as a single unit, ballasts for small lamps are often separate from the fixture. In this case, it is not unusual for the ballast to also be mounted as part of the distribution board rather than on the ceiling next to the lamp. (See Fig. 129, p. 200).
- **Grounding connection.** If equipment on the premises is to be grounded by connecting it to the grounded neutral conductor, the grounding conductor from this equipment should be bonded to the system neutral on the service entrance side of the distribution board, before any MCBs, fuses, or RCD. (When system grounding is recommended is described in Chapter VI, p. 60.)

From the distribution board to the various points around the home, several options are possible for housewiring. These can be broadly classed in temporary and permanent variants:



**Fig. 115. Housewiring neatly stapled to beams in a home in Gotikhel, Nepal. A wooden junction box is visible in the upper left.**



**Fig. 116. Commercially available plastic housewiring ducts.**

- Temporary wiring. This kind of housewiring is associated with some wiring harnesses and is used in homes built of "temporary" materials. In this case, the housewiring is simply tied to beams and posts as required. This design options is popular because the location of the housewiring and the lights to which it is connected can be easily modified to suit the occasion.
- Permanent wiring. In this case, the housewiring can be stapled to beams and posts within the home (Fig. 115). Alternatively, where the wall is of earth or cement, wooden strips are placed where the housewiring is to go and the housewiring stapled along these strips. A more recent variant is to use plastic ducts designed for this purpose (Fig. 116). The base of the duct is nailed or screwed to the wall, the housewiring is laid in the duct, and then the other half is mated to the base and snaps into place. This approach both secures and protects the housewiring.

### ***Standardized housewiring packages***

The purpose of standardizing housewiring is to facilitate this task and to reduce cost of materials and installation so as to permit rural households to be able to afford to connect. Two examples of standardized packages are discussed below:

- Pre-packaged components: In this case, standard packages of all the components needed to electrify a home are collected, packaged, and delivered to the home to be electrified. An example of a project utilizing pre-packaged components is found in Box 12.
- Wiring harnesses: These are pre-fabricated housewiring systems, produced in a range of standard sizes complete with in-line switches and light fittings. The harness is comprised of several leads taking off from a common point, a junction box within the home. The installation is simply a matter of securing the double-insulated conductors to beams or exposed building supports, usually by tying. The wiring harnesses used in Nepal are explained in Box 13.

**Box 12. Case study, El Salvador, 1989**

***Program overview***

In almost 30 years of rural electrification in El Salvador, housewiring has been largely ignored. Lines were extended into the rural areas under the assumption that, if electricity were available, potential users would flock to the electric utility requesting service. In an interview of 3,000 electrified and non-electrified residences in 1989, only 60 % of the dwellings within 25 meters from the lines were electrified over a period of 20 years. The principal reason for non-connection was the unavailability of cash up front to cover the cost of a service connection (\$90, which included the service drop wire and the meter installation) and housewiring (\$250, roughly a quarter of which was labor).

As part of a subsequent rural electrification program to make electrification more affordable to rural households, NRECA created a pilot credit program within the national utility CEL to offer both the service connection as well as the housewiring under a two-year credit program. Standardized housewiring packages were also a part of this program.

Four options were initially available (options that included from one to three 20-A breakers) but because of the increased complexity, these were narrowed down to two. Even though low initial loads were expected, housewiring and breakers were sized to accommodate maximum loads expected in any typical residence in the country, i.e., 15 or 20 A.

Each option included a fixed quantity of all the required, UL-listed\* materials needed for the job: appropriately sized conductor, staples for fastening it to the wall, ground rod, connectors, junction boxes, outlets, nails and screws, tape, and light bulbs to complete the job. The materials for each job were put into a cardboard box for delivery, along with an inventory. The packages were then delivered to each participating household. A local electrician was then contracted to undertake the wiring.

Although including a standard length of conductor limited somewhat the options for locating the receptacles, this was important to ensure the consumer saw that they were all treated equally. Furthermore, it was determined that customizing the conductor length added considerably to the cost of labor: increased administrative costs, additional visits to the homes to measure the conductor which would have been required, and the need to enter into a different contract between each household and the electrician. However, the consumers were notified that, if they wish, they could always make their own arrangements with the electrician to have more housewiring at an additional cost.

Standardization provided several cost advantages to potential consumers. It permitted bulk purchasing of housewiring materials that reduced cost of materials. It further reduced the cost by having the installations competitively bid and by organizing the housewiring program so that the winning electrician could wire a group of 10 or more houses at the same time. Costs were reduced in spite of the fact that all UL-listed materials were used (unlike those used by the utility) and the work was guaranteed.

In addition to reducing cost, housewiring was made even more affordable by replacing the previously required up-front payment of about \$340 with a token down payment and small monthly payments for two years.

*(Continued next page)*

\* Underwriters Lab is a widely recognized, private, not-for-profit safety testing and certification organization in the U.S. Safety requirements are based on its Standards for Safety. Additional information can be found on the Internet at <<http://www.ul.com>>.

### **Technical description**

Two housewiring packages were available: one providing 120-V service and the other also providing 240-V service (three-wire, single-phase) for running productive-use equipment.

Each configuration required an energy meter (installed by the utility) on the outside of the home as part of the service drop. And a circuit breaker box was mounted inside the home on the other side of the wall from the energy meter. A 1.6-m ground rod with pigtail was connected to the breaker box. Each package provided for a single circuit breaker serving two wall switches and two lights. In addition, the 120-V package (Package 1, Fig. 117) provided for a single circuit and receptacle with two outlets located in a convenient location in the home while the 240-V package (Package 2) provided for two circuits with receptacles, one at 120 V and the other at 240 V to run agro-processing and other productive-use equipment.

For Package 1 described below, the cost of materials and labor was reduced from \$250 to \$120. (Package 2 was about \$180.) This included a cost of installation of roughly \$10 that was paid immediately to the electrician upon completion of the task. The balance—the UL-listed materials for about \$90 (Table 18) and administrative cost and interest charges for \$20—plus \$90 for the service connection totaled about \$200. This was covered under a credit agreement where the consumer made a token down payment of about \$8 and monthly payments of \$8 for two years rather than a single payment of \$340 which was ordinarily required. (By relying on the local market, without giving any consideration for quality of materials, all the components, except for the conductor, could have been purchased for about half-price, reducing the cost from about \$90 to \$56. But they would have a significantly shorter service life.)

### **Conclusions**

In the pilot housewiring program that promoted this new option among 3,200 households, 95 % of the potential households were electrified within the first year of the energization of the lines where this program was implemented. This increased connection rate improved the cash flow for the utility and improved the system load factor considerably.

It is interesting to note that, while this pilot program successfully resulted in a very high initial connection rate and a more efficient usage of the electrical infrastructure, it was not adopted by the utility. Shortly after this project, the utility was privatized, and the new owners were interested neither in managing a credit program nor in even contracting this out to a third party.

**Table 18. Cost breakdown for materials used in the standardized housewiring Package 1.**

<b>Item</b>	<b>Quantity</b>	<b>Total cost (U.S.\$)</b>
Conductor (AWG #12 or #14)	40 m	20
Incandescent lights/fixtures	2	6
Switches	2	4
Outlets	2	8
Junction boxes	3	6
Breakers (15 or 20 A)	2	8
Breaker box	1	6
Ground rod, pigtail, connector	1	10
Entrance conductor	1	12
Misc. (staples, tape, nails, etc.)		8
<b>TOTAL</b>		<b>\$88</b>

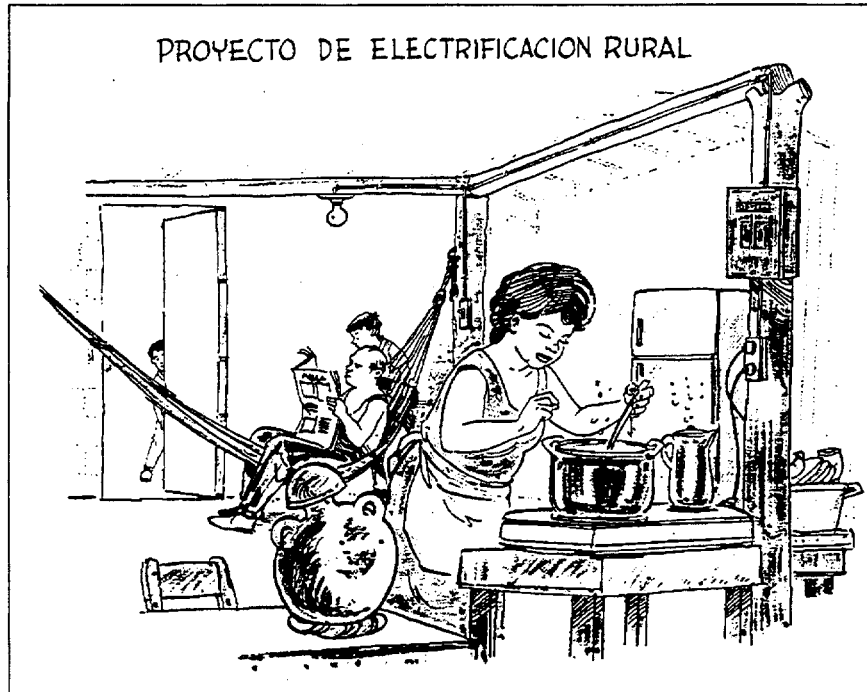


Fig. 117. A home wired with one of the standard housewiring package used in El Salvador (see Box 12).

- Readyboards: An alternative to a pre-fabricated wiring harness is a pre-manufactured distribution board. In South Africa where much of its development has taken place, this is aptly named a "readyboard" (Fig. 118). These readyboards are connected directly after the "metering" device. Even in the basic unit, the consumer protection includes a RCD. Also included are MCBs for lighting and plug circuits. The unit may have a number of breakouts for cables/conduits and the option of increasing the number of circuit breakers. Some units also come with a top-mounted light, and in the lower income households, this may be the principal use. The use of double-insulated wiring provides additional protection to the consumer. A readyboard is a part of the standard installation package used for township electrification projects in South Africa, and there are a number of companies that manufacture them commercially. The readyboards cost the utility approximately \$40 each.

The distribution boards used in Nepal as part of their wiring harnesses are essentially low-tech readyboards.

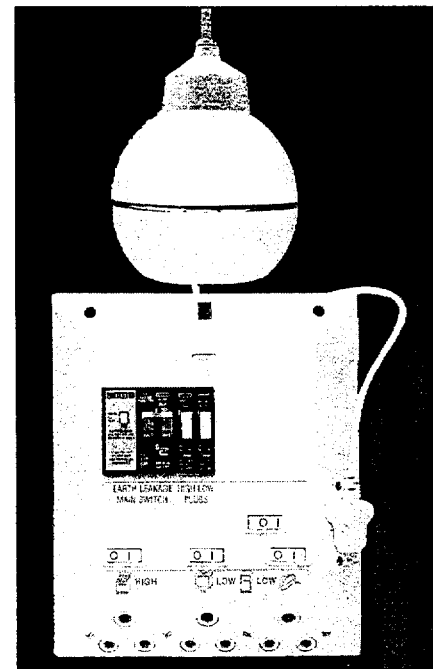


Fig. 118. Readyboard. (Source: Circuit Breaker Industries, South Africa)

### Box 13. Wiring harnesses in Nepal

In the Andhi Khola Rural Electrification Project in Nepal, both conventional wiring and wiring harnesses are offered to the householders. The conventional wiring installations are approximately six times the cost of wiring harnesses. The most basic wiring harness, which is made for two lights or one light and one two-pin socket costs roughly \$5 (Fig. 119). The wiring harnesses are installed by trained villagers, under supervision of the electricity supply company, and the lights are placed in positions decided by the

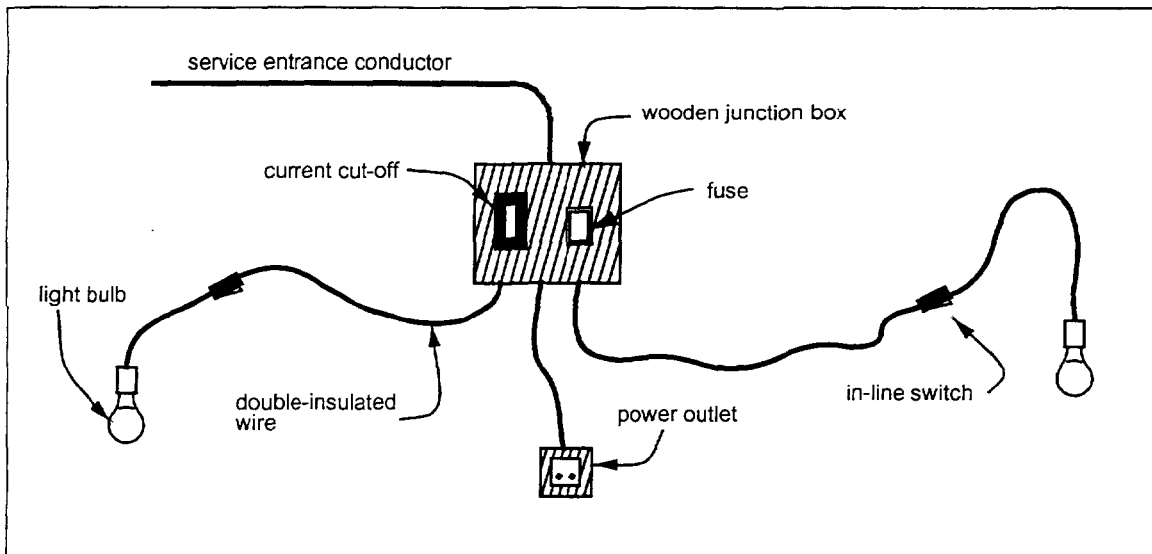


Fig. 119. Components of a typical Nepali wiring harness.

householder (Fig. 120). The cables are always of ample length. The excess length is neatly strapped and tied and can be undone if the lights are moved. This reduces the problem of the householder extending the wiring by twisting bits of wire together.

The wiring harness was developed to provide a safe, low-cost means of wiring the traditional thatched roofed houses. However, because of the flexibility it offers, it has also proved popular for the more solidly built houses with corrugated iron roofs. Conventional wiring installations are permanent, making it difficult to change the location of lights in a room.

The wiring harnesses are used in conjunction with load limiters. If a consumer pays the tariff associated with a larger current limiter, the wiring harness can be upgraded to allow for extra loads to be connected.



Fig. 120. Lightbulb and inline switch as part of a wiring harness.

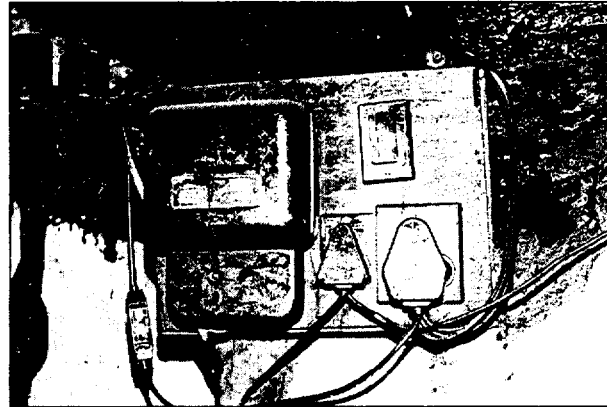


They are standardized units assembled under controlled conditions (Fig. 121). Installation simply requires mounting it on a secure surface in the home and connecting it to the service entrance.

Standardization presents a number of advantages:

- Bulk purchase of materials and labor permits a reduction in cost.
- The consumers can easily understand the price they have to pay for wiring their home. Standardization of two or three sizes and a fixed price for each removes any hidden charges and any consumer uncertainty about the cost for electrifying their homes. Typically, housewiring is undertaken by local contractors who generally have no vested interest in minimizing the cost of housewiring to the consumer. The cost they charge may be based on the number of components installed and the labor required for their installation. In these cases, they therefore have no incentive to minimize the number of components they install.
- The packages are prepared in a central location, permitting close control over what is included and the quality of materials and workmanship.
- The inclusion of the appropriate protection equipment, e.g., grounding, breakers, fuses, etc., can be ensured.

One minor disadvantage associated with this approach might be that it may limit the housewiring configurations. For example, in cases where the standardization of the available packages implies that a predetermined length of conductor for wiring the home is available, this restricts somewhat the wiring options within a home. However, standardization does not necessarily preclude wealthier households from wiring their home as they see fit by going to an established electrician.



**Fig. 121. Nepali readyboard with Norwegian current limiter, fuse, and two outlets.**



## **XIII. Operation, maintenance, and consumer services**

---

### **Operator selection and training**

The system personnel responsible for the operation, maintenance, and management of the powerplant and mini-grid play a critical role in ensuring a reliable and sustainable system. Even a costly, well-designed system with quality components may not continue operating reliably if these tasks are not properly handled. It is essential that the individuals selected to perform these tasks have a suitable attitude, aptitude, integrity, and rapport with the community.

If a private entrepreneur is responsible for the system, then he or she will likely select the operators or even serve in that capacity. This is the entrepreneur's prerogative. On the other hand, if an outside organization is assisting the village in project development and implementation, it may be its role to guide the selection of system personnel. To increase the chance that suitable candidates are selected, it might be advantageous to delay the identification of these individuals. In this case, as many community members as are interested should be involved in the project development and implementation from the start. Then based on an assessment of the capabilities of each of these individuals as the project evolves, how they interact with the others, their natural leadership capacity, etc., several would then be selected and trained in the actual operation and maintenance of the plant.

In this manner, while one or two individuals would eventually be selected from this set and given initial responsibility for project operation, the community would have a pool of individuals from which to draw in case the principal operators are not available, because they may have an obligation away from the village, may be ill, or may have to attend to more pressing matters. Identifying and training only one or two individuals from the outset puts the project at risk should they become unavailable for whatever reason.

The operator plays an important role in ensuring continued operation of the plant. To minimize training and backup needs and to ensure continuity, it is desirable that there be little staff turnover with this position. While it might appear appropriate to assign this responsibility to a younger member of the community who is looking for work, possibly one who has recently completed his schooling, a more suitable candidate for system operator might be an older person who is well established in the community, with his or her own home, land, and sustainable occupation. Younger individuals tend to be more transient and likely to take off to the more attractive urban areas in search of employment or other opportunities. Continuity is lost and a new operator would then have to be trained.

In addition to receiving training during project development and construction, training must extend over the long term to be effective and be on-the-job in nature. It cannot be done in an hour or two in a lecturing atmosphere. As part of this training, the implementing organization must periodically return to the community and monitor the status of the project, evaluate the quality and nature of the repairs or modifications to system design that have been implemented after the project was commissioned, review the maintenance records, and audit the books. Optimally, the operator should also feel that he or she can contact, and has access to, a suitably trained individual with the required expertise in a nearby town when needed.

## Regular operation and maintenance

A principal responsibility of the plant operator is to start and shut down the plant on a pre-established schedule and to ensure its proper and reliable operation. In performing this work, the operator must maintain up-to-date records in a logbook at the powerhouse. The date (and time, where relevant) of each observation must also be recorded. This record of plant operation can be used for a variety of purposes, such as:

- To determine when periodic maintenance must be undertaken.
- To contribute to the database which can be used to revise the tariff schedule.
- To assist with trouble-shooting any problems that may arise with the operation of the plant and mini-grid.

Items such as the following should be recorded:

- Daily hours of operation (when started and when shut-down). One purpose of these numbers is that they are an indication of when certain tasks must be undertaken (such as changing the oil, greasing the bearings, or undertaking minor and major overhauls).
- The energy (kWh) meter reading at the beginning or end of each day (if an energy meter is located at the powerhouse). This may highlight unusual day-to-day variations that could be indicative of some problem with the system.
- Output voltage and current readings from a voltmeter and ammeter with a switch (or an ammeter for each phase) which should be installed in the powerhouse. These are important indicators of potential problems that could lead to system failure, problems such as unbalanced phases, overloaded phases, unexpected loading, and abnormal voltage setting on the generator,
- The volume of fuel, oil, and/or grease added, with date. This is useful to calculate actual fuel expenses incurred in running the powerplant, expenses that must be taken into consideration when setting or revising the tariff. It can also be used to determine fuel consumption (liters per kWh), which can be an indication on the state of the powerplant, whether fuel is being siphoned off for unofficial reasons, etc.
- Any unusual observations (noises, unusually high fuel consumption, occasional high current demands that may be indications of faults or theft of power, details of low-voltage complaints by consumers, frequent breaker trips, etc.). Being aware of these factors is crucial if consumers are to continue getting reliable power and permit locating potential problems before they have an adverse impact on system operation.
- Date and explanation of any maintenance or repairs made.

The operator should also be responsible for making regular inspections of the mini-grid, ensuring adequate right-of-way clearance in the vicinity of the line and trimming any branches that could threaten the integrity of the lines; looking for signs of irregularities along the lines (such as unofficial taps to the line); and foreseeing potentially hazardous conditions along the line (such as caused by a broken guy or damaged pole, a new home being erected in proximity to the line or a service drop, or a severed ground connection).

Another task of the operator might be to collect payments for electric service from each consumer on some regular basis. A methodology for doing this must be established, and clear records must be

maintained and be available to be reviewed when necessary. Collection may, at times, prove difficult because some consumers wanting special favors (such as a delay or waiver in paying their bill) may place pressure on the operator. To facilitate his task, all consumers must be aware of the fact that the operator is responsible to others to ensure that all bills are collected and that he or she would be held personally responsible for any shortfall in the collection.

The village electricity organization should preferably establish an account with a local bank to ensure that revenues generated from the operation of the mini-grid are properly accounted for and accessible for the intended purposes (for paying staff and for covering costs of tools, supplies, and materials). A policy of multiple signatories might be established to ensure, to the degree possible, that one individual does not abscond with the savings.

## **Consumer education**

### ***Financial obligations***

Consumers must be made aware that they must pay for the service they agree to receive and that this is required for the ongoing operation of the plant. Any failure of the consumers to pay their bills puts the plant in jeopardy for the entire community. Furthermore, it must be made clear that if the consumer no longer has the wherewithal to pay, that household will be disconnected (unless the others are willing to cover the increased financial obligations).

### ***Disconnection policy***

To encourage payment of bills, a written policy concerning the disconnection of individual consumers from the mini-grid in case of non-payment must be clearly defined, readily available to all at the outset, and well publicized. Reference to such a policy should be included in an agreement into which each consumer enters with the village utility when applying for service (see p. 174). And it should be promptly enforced, without exception, and implemented in a transparent manner. Failure to forcefully implement a disconnection policy will contribute to growing problems, as one consumer sees that others are benefiting by circumventing established regulations and starts to follow in their footsteps. Gradually revenues will decrease to such a point that the system cannot cover costs incurred and will stop operating.

### ***Theft of power***

Consumers must also be made aware that any theft of power will not be tolerated because this will also threaten the operation of the entire system. A course of action should be clearly and explicitly defined if any consumer is found to be attempting to circumvent the normal operating procedures (e.g., bypassing the meters or current limiter or temporarily tapping the main line each evening upon cover of darkness).

### ***Awareness of options for electrical end-uses***

Many in rural villages are unaccustomed with the range of uses to which electricity can be put. This can limit the benefits that consumers can derive from electricity service if excess capacity exists. A promotion or awareness-raising effort should be implemented by the utility to address this issue. For example, with battery-powered radios and cassette players commonly found in rural homes, one electrical device that could have significant economic impact is an ac/dc converter to run these items from ac voltage or to use rechargeable batteries charged by the mini-grid. However, while this can have a significant economic impact on households—because batteries are such an expensive source of electricity—it is rarely promoted.

At the same time, it would be wise for those involved not to start promoting end-uses—such as hot plates or electric kettles—which should not be used if system capacity is inadequate. Their use would only create problems in the future.

## **Safety**

Especially because electricity is a new commodity in a rural community, all households, whether consumer or non-consumers, should be made aware that playing with or touching electrical lines can lead to death. This should also be emphasized by teachers in the schools. Some of the cautions ideas that must be shared with the community include the following:

- Stay away from any downed conductors and immediately notify the plant operator to shut down the plant so that repairs can be made. Although low-voltage lines will generally appear harmless, they can still present a potentially lethal shock.
- Water is usually a good conductor of electricity and persons should never be standing in water or on a wet surface while touching an electrical switch or appliance or plugging in an appliance. These may be designed to be safe but can occasionally fail. Washing babies or clothes should be done away from electrical circuits or appliances.
- Before replacing light bulbs, ensure that electricity to that fixture has been turned off.
- Any extensions of housewiring, except through the use of properly made extension cords, should be done by a qualified individual or at least inspected by one.
- No one should climb poles for whatever purpose, because this can pose a risk to both the climber as well as others in the vicinity.

For a larger electrification program, well-illustrated electrical safety brochure can be prepared and distributed to each household in the community. (Because of cost, printing such brochures may be out of the question for a single village project.) This brochure should highlight the various dangerous situations associated with electricity. In addition to text, presenting a graphical presentation of the information is often more attractive and more meaningful to all. Text should be kept to a minimum.

In some countries, posters are popular and are stuck on the walls inside the home as decoration. Attractive educational posters with clear illustrations can be distributed to all households and schools.

## **Consumer agreement**

To minimize problems that may frustrate the continued successful operation of a project, it is wise to ensure that consumers are aware of their obligations and of the repercussions for failing to live up to these obligations. One mechanism for achieving this is to have each consumer sign an agreement or contract when he or she applies for service. This agreement should describe the obligations of consumers wishing electric service. Box 14 shows a variation of an agreement that is widely used between consumers and their neighborhood mini-grids in the Philippines. In this case, each mini-grid is supplied by a metered transformer located along a line extension from a distant, much larger, rural electric cooperative. This agreement shown is only meant to serve as an example. The actual agreement should be designed to be as short and as clear as possible and to include those issues that are appropriate to the specific system under consideration.

**Box 14. Example of agreement between a consumer and the electricity supplier, based on an application for service from a Barangay (neighborhood) Power Association in the Philippines.**

**[NAME OF COMMUNITY ELECTRICITY SUPPLIER]**

I, the undersigned, agree to purchase electricity from [name of community electricity supplier] under the following terms and conditions:

1. The undersigned shall comply with the policies, regulations, and tariffs established by the [name of community electricity supplier].
2. The undersigned shall have his premises wired in accordance with the wiring specifications approved by [name of community electricity supplier]. The undersigned shall allow employees of [name of community electricity supplier] to enter his or her premises if there is valid reason to suspect the illegal use of electricity or dangerous modification of the housewiring.
3. The undersigned shall not be party to the vandalism, theft, or destruction of electric facilities which could jeopardize continued safe electric service to the community.
4. The undersigned shall support and cooperate with staff of the [name of community electricity supplier] to curtail pilferage of electricity and tampering of electric meters, clear the right-of-way, and remove constructions that may hamper delivery of electricity or pose a danger to life and property.
5. The undersigned shall not, in any manner whatsoever, pilfer electricity either directly or indirectly, install illegal and/or unauthorized connections, or tamper with his or her electric meter. It is in the interest of the undersigned to discourage other consumers from engaging in illegal activities or to report such occurrences.
6. Out of respect for, and in recognition of, the rights of other consumers and to avoid disconnection by the [name of community electricity supplier], the undersigned agrees to pay his power bill to the [name of community electricity supplier] in the prescribed period and not to engage in the aforementioned illegal activities.
7. The acceptance of this application shall constitute an agreement between the undersigned and the [name of community electricity supplier].

\_\_\_\_\_  
Date

\_\_\_\_\_  
Applicant's printed name

\_\_\_\_\_  
Consumer no.

\_\_\_\_\_  
Signature

Approval:

\_\_\_\_\_  
Chairman

[name of community electricity supplier]



Fig. 122. Part of a cartoon strip illustrating uses to which electricity can be put. (Source: NRECA/Guatemala)

Under some circumstances, utilities require a security deposit from consumers before providing electric service, an amount that is returned to the consumer if he or she should terminate service. Such deposits are more widely used in urban areas where the community is less cohesive and where households can pack and leave from one day to the next. In these cases, agreements could also specify the size of a safety deposit that may be required from each consumer. The electric utility draws on these deposits only if consumers incur costs that they fail to pay before they are disconnected.

## Consumer services

In addition to providing consumers guidance on the safe use of electricity, the village electric utility can also provide other services to the consumer.

### *End-use promotion*

If sufficient generation capacity exists, one service would be to make consumers aware of uses to which electricity can be put, productive or otherwise, such as grain grinding, refrigeration, fans, television, battery-charging (nickel-cadmium or automotive), blenders, soldering, and a village cellular-telephone post (Fig. 122). The uses promoted should only be those which contribute to the objective of operating as efficient a system as possible. For example, ironing clothes should not be promoted for small diesel systems while it might be promoted during the daytime for micro-hydropower systems (as long as their numbers can somehow be regulated, such as by the use of limiters). A diesel system with excess capacity might promote battery-charging with families outside the village when it is operational or this could be an overnight end-use promoted to make use of excess hydropower capacity beginning later in the evening.

In situations where generator capacity is limited but where incandescent lighting is the norm, the wider use of more efficient, although more expensive, fluorescent lights can be promoted. Along these lines, a service to consumers would be to provide credit to encourage the use of such lighting. This could be paid back over time by a slight increase in the tariff. As was illustrated earlier in Table 1 (p. 25), the cost of the lamp is insignificant compared to the cost of energy over the life of the lamp or bulb, so there is little risk to the utility in providing credit and a significant advantage for all. Depending on the size of the plant in comparison to the expected load, it might be advantageous to offer perspective consumers the



choice of fluorescent lighting units at the same price as incandescent units, with the balance paid back through the tariff.

### ***Sales outlet for electrical components***

An associated service which the village utility can perform itself or through a local entrepreneur is to make available for sale items such as bulbs, fluorescent tubes, fixtures, conductor for housewiring, small ac/dc radios, and other hardware and equipment which would be in demand by the villagers. The utility involvement in this service would have several advantages:

- It could save villagers time and money by making supplies that it can purchase in bulk available locally.
- It could ensure that a standardized set of materials and equipment of appropriate quality and capacity are used: conductor, fluorescent fixtures with power-factor correction, appropriately sized light bulbs and fuses, etc.

### ***Battery charging***

Because of the cost of battery chargers and rechargeable batteries (see p. 35), another service that the village utility could provide is to either charge batteries or to rent charged batteries. For nicad batteries, the utility would cover the initial high cost of these batteries and rent them out for a fraction the cost of the usual dry-cell batteries. The only risk facing the utility would be that villagers might not return the discharged batteries. But this issue should be fairly easy to address within a typical community. Such an approach could also facilitate the proper disposal of spent batteries, as this could be done by the utility itself. At present, batteries are simply discarded outdoors but as they corrode, they may leave behind traces of toxic metals.



## XIV. Tariffs

---

### Introduction

For any mini-grid project, covering the cost that has been incurred in the construction of the powerplant and the distribution system as well as the cost of the electric power that is generated is critical to its ongoing success. For this purpose, a properly designed tariff schedule defining what each consumer must pay for continuing to be supplied with electricity has to be established. To achieve this objective, the tariff should not be arbitrarily set by simply adopting the tariff that is used by the national utility, on the grounds of being “equitable”. It should not be set equal to the current expenses incurred by households for those uses for which electricity will substitute (i.e., costs of batteries for radios and TVs, candles and kerosene for lighting, etc.), under the assumption that this is what consumers can afford. And neither should it be set based on political considerations, because these generally have little correlation with pivotal financial considerations. If the tariff were to be set by any of these methods, there is no guarantee that sufficient revenues would be gathered. In this case, the system would then not be able to be maintained, it would falter, and the investment in the project in terms of time, energy, and financing would probably have been wasted.

To achieve its objective, a tariff must be designed to generate revenues to cover all the construction and operating costs of a generating/distribution system, plus a profit or margin if that is required by the owner of the system. These cost components must first be calculated, the revenues that must be raised to cover these costs are then determined, and a tariff schedule to raise that revenue must finally be established.

This chapter first identifies the costs that are incurred in implementing and then operating a mini-grid project. It then briefly reviews the options for covering these costs and follows by describing how costs to be raised each month are calculated. This chapter concludes by describing different types of tariff and illustrating how tariff schedules for mini-grids might be established.

It is the role of the project implementer, who should be aware of the economic realities in the community, to assess project costs, to identify what portion can be covered up-front, and to configure a tariff structure that covers the balance of these costs and ensures equitable access to electricity by all consumers.

### Project costs to be covered

The following costs are typically incurred in constructing and operating a mini-grid:

1. Capital cost of the project, which includes items such as the following:
  - Planning and design
  - Land acquisition
  - Powerhouse
  - Generating plant with controls (genset; hydropower turbine/generator with governor and/or load controller; PV array or wind turbine, batteries, electronic controller, and inverter; etc.)
  - Poles
  - Conductor for the main distribution line and service drops

- Poletop hardware (insulators, connectors, clamps, lightning arresters, etc.)
  - Other hardware (grounding rods; guy wires, attachment hardware, and anchors; etc.)
  - Housewiring materials, if costs are covered by the project (housewiring, staples, insulating tape, distribution board or junction box, breakers, fuses, current-limiters, lighting fixtures, outlet receptacles, etc.)
  - Tools
  - Labor (construction, wiring, inspection, project commissioning, etc.)
  - Transport and handling
2. Recurring operation and maintenance (O&M) costs, which include the following items. For each of these items, both the cost and the period over which this cost would be incurred must be specified.
- Fuel costs (e.g., diesel fuel and lubricating oil). This is the major recurring cost for a mini-grid supplied by an internal combustion engine. For renewables systems, this cost is minimal.
  - System operator
  - Materials (grease, belts, replacement lights, administrative supplies, etc.)
  - Equipment repair and overhaul.
3. Interest payments, if loans are necessary to cover a portion of project cost.

## Options for covering project costs

These costs can be covered in several ways:

- **Grants.** This type of funding may be available from the local or national government, bilateral aid organizations, private businesses, or non-governmental organizations (NGOs) to cover a portion of a project's capital cost. A common rationale for grants is that project beneficiaries—families residing in rural areas—are at a disadvantage. An initial infusion of capital is then seen as assisting them to be in a better position to maintain the developmental momentum that is expected or hoped will result for the project. While a range of benefits is associated with electrification, some may be difficult to quantify, and they may not necessarily result in immediate cash returns to the beneficiaries themselves. These benefits may include reduced urban migration and attendant problems, a more agriculturally productive nation, reduced adverse environmental impacts, or a better educated and healthier citizenry. In making subsidies or grants available, national governments or other entities like the Global Environmental Facility (GEF) can be seen as placing a monetary value for these benefits.\*

Contributing grants or subsidies to cover a portion of the capital cost of a project can be justified. However, these should never be expected to cover ongoing recurring costs or equipment replacement costs, because this can never be guaranteed by the donor. If the on-going

---

\* The GEF is an independent international financial entity implemented by the U.N. Development Programme (UNDP), the U.N. Environmental Programme (UNEP), and the World Bank which defrays the costs of making planned projects environmentally friendly, with the aim of sustainable economic development.

sustainability of a project were to depend on such funding, the project would stop functioning once this funding is no longer available. Nowadays, most donors are aware of this. If a community itself cannot fully cover at least all recurring project costs, then the advisability of proceeding with the project should seriously be questioned.

- **Up-front villager contributions.** To reduce the monies that must be raised externally or borrowed, the villagers themselves may raise some monies at the outset of a project. These contributions, when made by families with little disposable income, are also seen by external project funders as an indication of villager commitment to the project.

Several avenues are open for making such contributions. For many projects, individual household can cover all housewiring costs, and this can be considered as an up-front villager contribution. Villagers might reduce project cost by providing a portion of the labor required to implement the project (sweat equity) or by providing suitable poles or other required materials. And finally, each household in the village may decide, or be asked, to make an up-front contribution to defray a portion of the remaining costs. For grid-connected homes, this is often referred to as a connection fee.

While up-front villager contributions might appear an attractive manner of buying down project cost, little disposable income among some households may prevent them from getting electricity service, depending on the magnitude of this contribution. This may introduce a feeling of resentment or inequity among those households left out. Therefore, if it appears that this could be a problem, it might be best to avoid an up-front contribution (except for possibly the cost of housewiring) and rather to include this as part of the tariff, to be paid over time. This will generally make electrification more affordable, will increase the numbers of households served, and, by increasing the consumer base, should decrease the amount which each must contribute toward total project cost.

- **Loans.** These would be required to cover the balance of the capital costs (i.e., those not covered by the above two mechanisms). The usual source of loans for this purpose is from NGOs. They may maintain a revolving fund for such development projects or may channel funds through a development bank in the country and guarantee these loans. These loans might also be available at subsidized rates, under the implicit acknowledgment that it is difficult for such projects to cover their costs with loans available at commercial interest rates. In theory, loans would also be available from commercial banks but, unless it is a loan to an individual, banks are likely to be hesitant to loan to community organizations for such unconventional projects. Whatever the source of the loan, it eventually would have to be repaid by the villagers by including the sum for loan repayment as one component in the regular tariff payments.

## Calculating monthly costs

Either grants or up-front villager contributions are used to cover at least a portion of a project's cost. Any remaining balance would have to be covered by a loan of some form. Loan repayments would then be made using revenue generated through monthly consumer billing. The size of the revenue that must be raised to cover loan repayment and other recurring costs are calculated as described below.

In this discussion, it is assumed that a loan has been taken out and that the monthly tariff must generate adequate revenue to repay the loan over the period of that loan. If, for example, the loan is to be repaid over a 5-year period, the tariff would be set to cover this sum over the first five years of the project. After

that period, the loan would have been repaid, and the tariff could be recalculated because it would no longer need to include a loan repayment component. Other assumptions may have to be made and other cost components may have to be included in the tariff, as necessary, to reflect the actual project situation.

This exercise is useful as it will illustrate what consumers must pay every month in order to cover the actual capital and recurring cost of a project. It will illustrate that, unless a grid can be built at a low life-cycle cost and be well managed, consumers will have to pay considerably for electricity supply. This is the reason that rural electrification around the world often has to be subsidized. However, if a project is well implemented and yields benefits to the nation (reduced urban migration, better health, employment opportunities, value added to rural raw materials, etc.) as well as to the consumers themselves, subsidies may simply be seen as the cost for obtaining these benefits.

The following steps illustrate how to calculate the revenue that must be raised each month to cover project cost. An example is found in Box 15.

1. Calculate loan repayment. If a loan is necessary to cover a portion of project cost, tariff payments will have to generate adequate revenue with which to make regular loan repayments. The loan amount  $L$  would equal the capital cost of the project, minus any grants or up-front villager contributions. Based on the terms of the loan (annual interest of  $i$  over a period of  $N$  years), the monthly payment  $PMT$  to repay the loan in equal installments would be the following:

$$PMT = \frac{L}{12} \cdot \frac{i}{\left(1 - \left(\frac{1}{1+i}\right)^N\right)}$$

Rather than using the above equation, the monthly payment can also be obtained by multiplying the loan amount  $L$  by the appropriate factor from Table 19.

2. Calculate fuel costs (if a diesel genset or other form of internal combustion engine is used). Based on the envisioned uses to which electricity will be put, the monthly consumption of the community (kWh) can be estimated by summing the product of (i) the average power each household is expected to use, (ii) the average length of time each day it is to be used, and (iii) a factor of about 30 (days per month). Then knowing the specific energy output of the genset (kilowatt-hours generated per liter of fuel consumed) from literature, the supplier, or historical data from units operating elsewhere, it is possible to estimate the volume of fuel (liters) required each month. The cost of that fuel delivered to the site  $C_f$  (\$ per month) can then be calculated. Once the plant is operational, one of the tasks of the plant operator will be to regularly record the

**Table 19. Factor by which to multiply loan amount to calculate monthly payments, based on the interest and term of the loan.**

Term (years)	Annual interest				
	4%	8%	12%	16%	20%
2	0.044	0.047	0.049	0.052	0.055
4	0.023	0.025	0.027	0.030	0.032
6	0.016	0.018	0.020	0.023	0.025
8	0.012	0.015	0.017	0.019	0.022
10	0.010	0.012	0.015	0.017	0.020
12	0.009	0.011	0.013	0.016	0.019

actual fuel use by the plant to determine whether the tariff must be modified in light of actual fuel consumption figures.

3. Depending on the ownership/management structure, the plant operator(s) may also receive a monthly fee  $C_O$  as remuneration for services rendered.
4. Certain interventions will be necessary at regular intervals to ensure that the powerplant continues to operate satisfactorily. These might include the replacement of drive belts, air or oil filters, and bearings; refurbishing the powerplant; and minor and major overhauls. Many of these tasks are done after so many hours of operation (e.g., replacing the oil every 500 hours of operation or undertaking a major overhaul every 3,000 hours). These time intervals must be obtained from the equipment manufacturer or supplier, from those with experience with operating similar plants in the country, or possibly from technical school instructors. In addition to determining these intervals, it will be necessary to obtain an estimate of the cost of each intervention, both labor and materials.

For each of these tasks, determine the cost and period between interventions. From this period and a knowledge of how many hours each month the plant will be operating, estimate how many months pass between interventions. Then divide the cost of each intervention by this interval to obtain an estimate of the cost on a monthly basis. Add the costs for all the major interventions to get the total cost  $C_M$  (\$ per month) for maintenance, repairs, and overhauls.

5. For some projects, funds are generated to cover the cost of a replacement powerplant  $C_R$ . If the cost of the original powerplant is being borne by the community, paid for either by a loan or by up-front villager contributions, it may be assumed that the same process would be used to purchase the replacement unit(s). In this case, adding this cost component to arrive at the monthly cost is not necessary. However, if the cost of the original powerplant was covered by a donor and if the project is designed to be sustainable without additional inputs from a donor, then this cost component must be included to ensure sufficient cash will be raised to cover the cost of replacement units by the time the original unit fails. To determine how much must be set aside each month, assuming that these funds are placed in an interest-bearing savings account, multiply the expected cost of the powerplant when it is to be purchased by the suitable factor in Table 20.
6. Determine what other costs must be covered by revenues generated from the sale of electricity for that specific project,  $C_X$  (\$ per month). This could include such items as profit, other administrative costs, taxes, etc.

**Table 20. Factor by which to multiply the expected future price of a powerplant to calculate monthly payments which must be invested each month for the time indicated.**

Time (years)	Annual interest				
	0%	2%	4%	8%	12%
1	0.083	0.083	0.082	0.080	0.079
2	0.042	0.041	0.040	0.039	0.037
3	0.028	0.027	0.026	0.025	0.023
4	0.021	0.020	0.019	0.018	0.016
5	0.017	0.016	0.015	0.014	0.012
6	0.014	0.013	0.012	0.011	0.010

After the values have been calculated, the total monthly cost  $C_T$  for operating the system and for paying back the initial investment is simply the sum of individual costs described above:

$$C_T = PMT + C_F + C_O + C_M + C_R + C_X$$

Box 15 illustrates how these basic equations are applied in a specific situation. Note that if the loan is to be repaid over 6 years, the tariff must raise an average of \$7.30/month/consumer. But if the term for the loan is doubled to 12 years,  $PMT$  will be somewhat reduced, and an average of \$5.90/month/consumer would have to be raised monthly. With a 6-year loan, if the cost for the entire project is covered by a grant and no loan were necessary, the tariff would fall to \$3.50/month/consumer to only cover O&M costs. On the other hand, if the community were to cover all project costs with its own resources, including the cost of a replacement engine, project cost would average \$9.20 monthly for each consumer.

## Basic tariff types

The previous section briefly described how the revenues required to support project costs are established. The purpose of a tariff schedule is to define the structure by which the various consumers will then contribute to these revenues. While there are numerous options, they basically fall into two categories: energy-based and power-based.

### **Energy-based tariff**

The bill paid by a consumer under this type of tariff is determined by the actual quantity of energy is actually used by the consumer. This is measured through the use of an energy or kilowatt-hour meter. This may be regarded as a more equitable approach, because a consumer is charged according to the energy actually consumed. Those who use less electricity pay less.

Energy meters are commonly used for large-grid-connect systems, where they present several advantages:

- They provide an accurate record of power consumption for both billing and planning purposes.
- Meters encourage energy conservation because the customer's consumption directly determines his or her bill. The consumers save if they reduce electricity use.
- Meter readings can help with the detection of fraud or meter failures because unusual trends in consumption can be used as a signal to initiate an investigation.
- Time-of-day meters (i.e., meters which measure consumption during different portions of the day) can be used that discourage consumption at peak times and encourage the use of off-peak power (although these are more expensive than standard meters).

However, meters also have a number of drawbacks:

- Good-quality meters add to the consumers' cost for accessing electricity. In an attempt to reduce this cost, low-quality energy meters may be used and these may have the problem of unreliably recording the low demand levels (e.g., 10 W to run a fluorescent light or less to power a small radio). More importantly, the costs associated with meter reading, accounting, billing, and revenue collection are significant, especially if the consumers are widely dispersed or remotely located. With low consumption levels commonly found in rural areas, these costs can add considerably to the overall costs of service.



**Box 15. Example of deriving the monthly revenue required to cover project costs.**

A village with 40 families has undertaken a mini-grid project powered by a 3 kW diesel genset dedicated to electricity generation for residential use. All families have indicated an interest in receiving electricity and it is estimated that they would use an average of 60 W for the four hours that the plant will be operating every evening.

The capital cost of a mini-grid project, including a powerplant and housewiring is \$12,000. To cover this cost, a grant for \$4,000, which also covered the cost of the diesel genset, was obtained. The balance was loaned to the community by an NGO under the agreement by which loan repayments would be deposited into a revolving fund that would then provide a source of funding for future projects. The agreement stipulates that the loan has to be paid back in equal installments over 6 years at an interest rate of 10%.

The plant operator will be paid a sum of \$20/month to operate the plant, to undertake routine maintenance, and to collect the monthly payments from the consumers.

The supplier of the diesel genset notes the following:

- Fuel consumption: 2 kWh per liter when the plant is running above half-load and the cost of diesel fuel in the village is \$0.40/liter.
- Oil change every 300 hours at a cost of \$5.
- Overhaul every 4,000 hours at a cost of \$1,100.

Determine the monthly costs to be raised by revenue from the sale of electricity to cover all costs incurred and estimate what the average tariff should be levied on each consumer to generate this revenue.

**Solution:**

1. Covering a loan of \$8,000 at 10 % for 6 years would require a payment of  $PMT = (\$8000)(.019) = \$152/\text{month}$ .
2. The monthly energy requirement will be

$$(40 \text{ consumers}) \left( \frac{60 \text{ W}}{\text{consumer}} \right) \left( \frac{4 \text{ hours}}{\text{day}} \right) \left( \frac{30 \text{ days}}{\text{month}} \right) = 290,000 \text{ W} \cdot \text{hours} = 290 \text{ kWh}$$

This will require about 150 liters of diesel at \$0.40/liter, costing  $C_F = \$60/\text{month}$ .

The operator's remuneration  $C_O = \$20/\text{month}$ .

Each month, the mini-grid will be operating 120 hours. Maintenance is restricted to an oil change and an overhaul. On a monthly basis, the cost for these will be

$$C_M = \frac{\$5}{2.5 \text{ months}} + \frac{\$1,100}{33 \text{ months}} = \$35/\text{month}$$

The diesel engine has to be replaced in about 6 years for a future cost estimated at \$2,300. Revenues of  $CR = \$26$  must be invested monthly in the village's savings account at 8 % interest.

The total revenues which must be generated is  $C_T = \$290$ .

The tariff schedule must next be set in order to generate \$290 monthly to cover the cost of generating 290 kWh during this period. Several examples of tariff schedules are found in Box 16.

- Consumers, who have had no formal education, may have difficulty understanding how to read the meter and, therefore, the charge they are required to pay. This can result in unexpectedly high bills and, in some cases, can lead to exploitation by fraudulent meter readers.
- Meters alone do not limit peak demand of each consumer; neither do they prevent the supply from becoming overloaded. If meters are used, without additional load-limiting components, it is possible for a few, wealthier households to consume more than their share of the power, leaving little for the others, or to even overload the system. For small schemes with limited generation capacity, it is essential that this condition be avoided so that the power available can be equitably shared.
- With a system employing conventional energy meters and meter readers, if any consumer does not pay his bill, he or she will eventually (the sooner the better) have to be disconnected and then reconnected if and when cash is again available. The utility and the consumer have to bear the cost of these activities and the inconveniences.

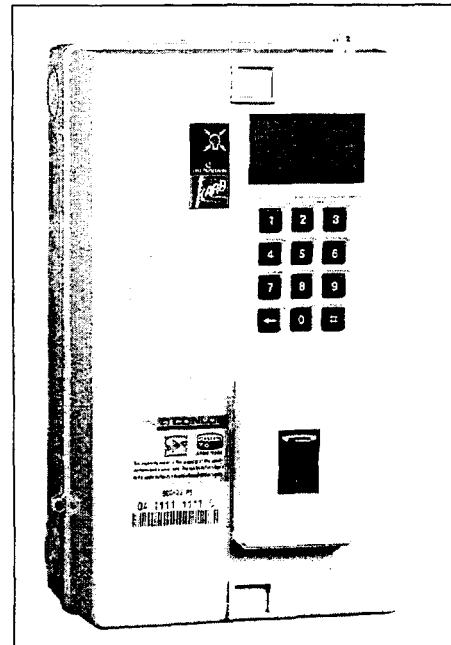
The drawback arising from the additional cost of meter reading and billing associated with the use of energy meters can be partly addressed by performing these tasks at less frequent intervals or by having the consumer read his own meter (and periodically cross-checked by the system operator).

The prepayment meters (or electricity dispensers) are another alternative which obviates the need for meter reading, billing, and collecting altogether (Fig. 123). This represents a relatively new alternative to conventional metering that addresses all except one of the drawbacks of energy meters listed above.

Prepayment meters require the consumers to purchase units of electricity from the electricity supplier in advance, in a similar way they purchase other energy supplies, such as kerosene, candles, batteries, or wood. Depending on the system, the consumer purchases a magnetic card or a token or receives a payment number that, in coded form, includes some indication of the number of units (kilowatt-hours) purchased. The consumer inserts the card or token into the meter or enters the number through a pushbutton pad incorporated on the unit. This credits the consumer meter with the number of units purchased. The meter displays the number of units available and subtracts from this number as they are used. Depending upon the design of the meter, it may also indicate a variety of other data, such as the rate of consumption and the quantity of electricity still unused. It can also provide the consumer a warning when the credits are almost exhausted.

The advantages of the prepayment meter include:

- No meter reading required.
- No billing required.
- Prepayment means no overdue accounts. Consumers who have insufficient money to purchase electricity simply do without it until they again find the necessary funds. They do not have to bear any disconnection and



**Fig. 123. Prepayment meter (Source: Conlog South Africa).**

reconnection costs.

- Easy budgeting by the consumer and the ability to pay for small amounts in the same way that other energy resources are purchased.
- No consumer inquiries and complaints regarding bills.
- No problems associated with bad or non-existent postal systems or customers having no formal address at which to receive bills.
- It facilitates energy conservation as the consumer can easily relate expense to appliance usage.
- Time-of-day tariffs can be programmed into the meter and easily modified.
- It automatically disconnects the consumer if he or she is unable to pay the bill, avoiding bad feelings that may arise if the system operator disconnects the consumer.

The main disadvantages that remain or have been introduced by this new technology are the following:

- The cost of the meter and card/token/number dispenser is high.
- A well-organized sales and support service is required.
- The burden is on the consumer to go to the electricity supplier's office or shop that has been fitted with the necessary equipment to purchase electricity. The customers must therefore be within easy reach of this service as they may wish to buy cards several times each month.
- Although not a major disadvantage, customers need some training on how to use prepayment meters.

Despite the numerous attractive features of prepayment meters, the high cost of the equipment and the sophisticated support services required preclude this from being a viable alternative for mini-grid applications. By their nature, mini-grids have too few consumers to provide an economic justification for this option.

### ***Power-based tariff***

In this case, the tariff is based on the maximum amount of power used by the consumer. The power available to the consumer is predetermined and payment is made on the basis of this power level. The simplest variation of this approach is to base the level of consumption on a written or oral agreement with the consumer (e.g., limiting consumption to no more than two 10-W bulbs and a small B&W television or paying 50 rupees (US\$ 1) monthly for each light bulb installed). This approach has the clear disadvantage that there is no way of enforcing this limit and it is therefore open to abuse.

Another variation is to electrically limit the power consumer by limiting the current into the home (p. 155). Load limiters have a number of advantages over metered connections:

- They limit peak demand and therefore prevent overloading of generators (or transformers) and the distribution lines. Consumers cannot, on their own, decide to increase their consumption.
- By preventing excess consumption by a few individuals who might consume whatever level of power they wish to use because they can afford it, use of limiters can ensure that all consumers can get access to some electricity.
- Costs associated with meter reading are removed.

- Payment is simpler for both the collector and the consumer, as the amount to be paid on a regular basis is known.
- Fraud and confusion relating to the payment process are greatly reduced.
- The payment can be required in advance to ease cash flow for the electricity supplier.
- Reliable load limiters are less expensive than reliable electric energy meters.
- Loads with low power factors (such as uncompensated fluorescent lamps) make inefficient use of available current. Excessive currents in the system lead to energy losses or the need for increased investment for additional generating and distributing capacity to more efficiently handle these increased currents. Standard electricity meters do not record usage of these excess currents. This might be seen to benefit the consumer but places extra burden on those responsible for the viable operation of the mini-grid. However, in measuring current, load limiters sense the total current used and tend to place the burden on individual consumers to improve their power factor (provided that they are made aware of how this is done). This benefits both the consumers who can effectively increase the power available to themselves at no increase in energy cost and to the utility which incurs fewer losses in the distribution line and generator.
- Load limiters encourage off-peak consumption of electricity, which is especially desirable when the "fuel" to produce the electricity is free and no storage is involved, as is the case of most micro-hydropower schemes. This encourages the more efficient use of the energy resource.

The main disadvantages are:

- Restricted electricity availability for the consumer. To encourage this option, load limiters must have a clear financial advantage over a metered supply for consumers, especially if they realize this is not the way electricity is conventionally "metered" in urban areas.
- Increased opportunities for fraud and theft by consumers tampering with the load limiters. Such tampering is difficult to detect because, unlike with a metered supply, there is no record of the quantity of electricity consumed. Automatically-resetting load limiters are an exception, since they can be mounted high on a distribution or service connection pole to deter bypassing or other types of tampering.
- Uneconomical use of electricity. Load limiters do not encourage economical use of electricity because the consumers bill takes no account of the energy consumed. They could, for example, leave lights on all the time. But these consumers using limiters generally have little disposable income and would quickly realize that leaving lights on forces them to purchase light bulbs more frequently, adding unnecessarily to their domestic expenses. Measurements in Zimbabwe (Box 9) confirm that load factors are not excessive. Furthermore, a capacity-based tariff should not be used with larger consumers, as they can easily cover the cost of the meter.
- Poor reliability. Reliability can be a problem if load limiters that cannot withstand short-circuit currents are not sufficiently protected or if the accessibility required for manual resetting leads to abuse of the load limiter.
- Poor accuracy with certain limiters. Thermal devices such as standard miniature circuit breakers and thermistors have poor accuracy, especially where there are wide variations in ambient temperature. Magnetic miniature circuit breakers and ECBs are considerably more accurate.

- Consumer education is required to minimize customer dissatisfaction by making them aware that repeated tripping of the load limiter can be due to low power-factor appliances or to the use of appliances that have too high a current consumption for the load limiter.
- As with the conventional energy meters, non-payment requires disconnection of the consumer (and possible later reconnection) and the costs and inconveniences that these entail.

## Designing a tariff schedule

A wide variety of tariff schedules is possible. In designing such a schedule for a specific project, any one or more of the following characteristics can be incorporated. But whichever design is adopted, it must generate the revenues required to cover project costs. Characteristics include the following:

- Based on one or more fixed levels of demand. For example, consumers can subscribe to either a 25- or 50 W, load-limited service for \$0.50 or \$1.00 per month, respectively. Alternatively, they might pay \$0.02/installed watt, although this is more difficult to maintain and enforce.
- Based on actual energy (kWh) consumed. Based on kWh readings periodically taken from a consumer's meter (e.g., every month or two months), the household pays either a fixed price per unit (e.g., \$0.70/kWh) or any of several unit prices based on the total energy consumed (e.g., \$0.40/kWh for the first 10 kWh and \$0.70/kWh thereafter).
- Based on the type of consumer (with residential, commercial, industrial, and government consumers possibly having different rates).
- Based on time-of-day, a tariff generally available for consumers with larger commercial or industrial loads. Rates vary, depending on the time of the day that electricity is used. To avoid interference with lighting loads, lower rates may be offered during the daytime, for agro-processing, or during the late evening hours, such as for pumping potable water into a storage tank, when lights and other domestic loads are not being used. Electric utilities use time-of-day meters, which are more expensive, to ensure that special rates are only applied to electricity consumed during designated times. However, special time-of-day rates can also be applied for the few larger loads on a rural mini-grid even without time-of-day meters, through a written agreement. Any failure of the larger consumers to abide by such an agreement would be noticeable to other consumers on the grid. If the load is large, it would cause significant variations in the intensity of incandescent bulbs supplied by the mini-grid.
- Regressive (where larger consumers pay a smaller unit cost).
- Progressive tariffs (where the smaller consumers pay a smaller unit cost)

A progressive or regressive tariff is used to discourage or encourage increased energy usage, respectively, depending on factors such as cost and availability of fuel or the size of the generator in comparison to the load. The tariff schedule adopted may include several of these characteristics.

In addition to generating the desired revenues to cover project cost, the tariff schedule should also contribute to making electricity more affordable. Toward this end, the tariff schedule should be structured to strive to achieve these other objectives:

- To minimize the additional costs and complications incurred in generating and accounting for this revenue (i.e., the costs of metering billing, collection, and administration), especially if

affordability is an issue. For example, using a tariff based on a subscribed, maximum power level eliminates the need for meter reading, billing, and more involved accounting (see p. 186).

- To give even poor members of the community access to some basic electricity. This usually involves a low tariff, commonly referred to as a “lifeline” tariff, for the first several kilowatt-hours consumed, sufficient for basic needs (e.g. lighting and radio).
- To maximize the number of consumers, so that the capital cost as well as the cost for running the system are spread out over as large a consumer base as possible.
- To incorporate flexibility in the consumer payment schedule, a feature which is even more important when consumers do not have a regular income stream. This might be done by permitting advance payments or else bulk payments several times a year (e.g., when the harvest comes in).
- To encourage the productive (income-generating) uses of the power generated by the prime mover (e.g., by a diesel engine or a micro-hydropower plant)—through either a direct mechanical drive or an electric motor or other appliance—so as to generate additional income and thereby to reduce the costs that residential consumers would have to cover.
- To encourage demand-side management, such as encouraging other uses of electricity at times outside peak lighting hours in the early evening.

Examples of sample tariff schedules for the case described in Box 15 are found in Box 16.

### Box 16. Sample tariff schedules

Box 15 illustrated how the magnitude of the revenue that has to be raised each month to cover both capital and recurring costs of the project is calculated. Below, a variety of tariff schedules for generating this revenue is illustrated. Recall that in that example, \$290/month had to be raised to cover the cost of generating an estimated 290 kWh each month.

**Energy-based tariff:** This approach requires a meter to be read for the number of units consumed and bills to be prepared on this basis. Examples include the following:

- A basic tariff schedule is simply to bill each consumer based on a fixed rate. In this case, charging \$1.00 for each kWh consumed would raise the \$290 required monthly.
- A more complicated schedule would be to include a fixed charge. Consumers would have to pay this charge to cover sunk costs that have already been incurred (capital cost and cost of operator), irrespective of how much electricity they consume. In addition, a variable charge would be required to cover the other costs would depend on how much energy is consumed. For example, the tariff schedule could be \$4.30/month plus \$0.40/kWh. With 40 consumers using 290 kWh each month, this schedule would again raise the  $(40)(\$4.30) + (290)(\$0.40)$  or \$290 required. In this manner, if a consumer has financial constraints, he can consume less energy and reduce his monthly bill without jeopardizing the project's need to keep generating revenues to cover the capital cost.

**Power-based tariff:** This approach is based on paying a fixed amount depending on the amount of power (watts) to which each consumer subscribed. Examples include the following:

- Each consumer agrees not to exceed 60 W demand. Since \$290 must be raised from 40 consumers, each consumer must pay \$7.30 each month.
- A village includes 9 commercial consumers (restaurants and shops) who have 200-W current-limited service, with the remaining load composed of residential consumers who have a current-limited service of 20 W (for one or two CFLs and a radio). A tariff is set proportional to their demand: residential consumers are charged \$2.40/month while the commercial consumers are charged \$24/month. This tariff schedule has again been designed to generate \$290 each month.





## **XV. Appendices**

---

- Appendix 1. Case study: Ivory Coast
- Appendix 2. Case study: Laos
- Appendix 3. Case study: Irian Jaya
- Appendix 4. Case study: Dominican Republic
- Appendix 5. Calculating required pole diameter
- Appendix 6. Derivation of basic voltage drop/power loss equations
- Appendix 7. Computational examples
- Appendix 8. Sag tables for multiplex conductor
- Appendix 9. Areas for further inquiry



## Appendix 1. Case study: Ivory Coast

### *Project initiation*

To address the problem of urban migration by increasing the attractiveness of rural areas, the availability of modern services—including access to electricity and the benefits associated with it—is generally felt to be a necessary element. At least in theory, solar photovoltaic systems are seen as an electricity supply alternative well-suited for meeting the most common domestic demands—electricity for lighting and audiovisual equipment—and for specialized end-uses such as vaccine refrigeration or water pumping. But before this technology can find widespread application, the life of the components will have to be increased, their cost decreased, and mechanisms put in place for the financing of small systems and for their dissemination and ongoing maintenance. Today, such projects are still limited to programs heavily dependent on international aid.

APAVE, a French association of electricity producers, has been involved in a variety of development programs in French-speaking countries over the past 15 years, programs associated with conventional electrification as well as with solar photovoltaic applications. It felt that to meet the demand for small quantities of electricity, at least over the medium term, solutions more in harmony with the socio-economic character of rural areas were needed. On the basis of experiences gained, APAVE felt that, if technical and institutional designs could be developed that would permit the implementation of lower-cost systems that could be managed by other than the national utility, then this would open up the possibilities for broad rural electrification. These designs would have to maximize the involvement of local beneficiaries, to give them a stake in the project rather than leaving them on the sidelines as mere spectators. Relying on the local beneficiaries to contribute sweat-equity to the implementation of the project and to then manage and operate it would provide a more viable and realistic alternative to project implementation by the national utility and could further reduce costs.

APAVE consequently proposed an integrated approach to rural electrification referred to as "groupe électrogène-économie d'énergie" (GECO), which includes the generation, distribution, and use of electricity. It was designed to address the obstacles encountered by conventional approaches to rural electrification: high cost, overly conservative system design for the end-uses envisioned, and the limited number of consumers that could afford to connect.\*

### *Design concept*

The GECO concept includes the following basic features:

- The use of a small autonomous powerplant, generally a diesel or gasoline genset (although pico-hydropower plants<sup>†</sup> are also planned).
- A mini-grid supplying consumers with low levels of "basic" power.
- Electric service for only a portion of the day.

---

\* This case study is included because it illustrated one of several interesting options for off-grid electrification. However, the documentation used in its preparation left a number of issues unclear. An attempt was made to resolve these issues by contacting individuals connected with these projects; however, no responses were obtained.

<sup>†</sup> "Pico-hydropower plants" refers to plants harnessing small waterpower resources and generating no more than several kilowatts.

This approach focuses primarily on communities that generally have from 40 to 400 consumers (homes), where households are grouped together rather than scattered and are constructed of at least semi-permanent materials. To be able to spread the cost of the mini-grid over as broad a base as possible, a large majority of the households in each perspective community must be willing to become consumers; otherwise, the system is not built.

The genset supplies power for 3 to 4 hours every evening, primarily for internal and external high-efficiency lighting, public lighting, audiovisual equipment, and fans. Consumers each have 3 to 4 power points (i.e., each power point represents either a light fixture or power outlet). The average design power demand per household is generally in the range of 30 to 60 VA. Depending on the social and economic realities in each village, operating times and capacities of the power supply can be increased. Public lighting can be included if desired and if the community is willing and able to cover those costs.

The GECO concept imposes no specific management option. In the Ivory Coast, households within the community become members of a consumer cooperative and, in the process, each agrees to a memorandum of understanding between the two parties. This cooperative then undertakes the technical and financial management of the installation. It is also possible for the cooperative to contract part or all of the management to a private operator. This might be more appropriate in larger, more urbanized centers where the sense of solidarity is not as strong as in a rural setting.

While the system is designed to provide very small amounts of electricity, the objective is to design the system so that it will be completely compatible with grid-interconnection when it is available. At that time, the genset would simply be replaced by a distribution transformer and metering/protection equipment. Bringing conventional power to a village then becomes much more attractive for the national or regional utility because it would simply need to install a transformer, it would inherit a well-established load, and it would essentially serve one customer. It could therefore forego the complications involved in having to deal with numerous individual small consumers, where the costs it would incur in meter reading, billing, and collection could easily exceed any fee collected. The responsibility for ensuring prompt payment of the community's electricity bill to the utility would be transferred to the community itself through the cooperative originally set up.\*

At the time of interconnection with the grid, it is always possible for certain consumers (such as businessmen or craftsmen), with potentially larger demand, to opt for the conventional individual subscription contract that may meet their needs more effectively.

A part-time employee paid by the cooperative is in charge of the technical operations to the system. This individual is responsible for turning on and off the genset each day, for refueling and lubricating the genset, and for undertaking simple maintenance tasks. Most villages have local mechanics capable of maintaining and doing minor repairs on the genset.

The tariff level is set to cover the investment in the mini-grid, the operating costs, and the cost of the generating equipment. Each consumer pays a fee on the basis of the number of power points installed in

---

\* This concept is widely used by rural electric cooperatives in the Philippines to serve more remote neighborhoods or *barangay*. The utility supplies electricity through a metered transformer into a mini-grid that it is responsible for constructing. Legally established Barangay Power Associations accept responsibility for meter reading, billing, and collecting within their membership and for paying the utility, on a monthly basis, a lump sum based on single meter readings made each month by the utility at the transformer(s) serving the area. Enforcing prompt payment and dealing with theft of power within the community is no longer the burden of the utility but falls on the community itself which is generally better qualified to handle this issue.

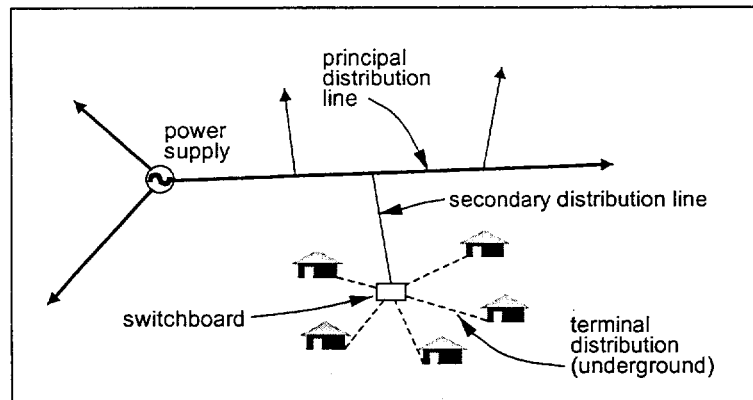
his or her house and a sliding regressive scale (decreasing cost of additional points). A volunteer from the cooperative is responsible for collecting the monthly tariff.

Financing of these projects are covered in part by initial contributions from the villagers. Subsidies or grants also cover part of project costs, while the balance is covered by a medium-term, soft loan granted by a local credit institution to the village cooperative. In some cases, these loans may be guaranteed by an international aid organization or other non-government organization.

### **Project technical details**

After a local community has expressed an interest in getting access to electricity, a study is undertaken to determine the technical and economic feasibility of a project. Potential demand is assessed at this time.

The type of generator used depends on the expected demand of the community. If demand does not exceed about 10 kVA, the community is broken down into blocks of unit demand that do not exceed 5 kVA. Each block is supplied by a single-phase genset feeding a 2-wire, single-phase network (Fig. 124). If demand exceeds 10 kVA, a three-phase generator is used, supplying the main lines of either three single-phase networks or a 4-wire, three-phase, main distribution backbone, which in turn supplies a series of single-phase networks.



**Fig. 124. Basic configuration of a GECO system.**

In most cases, these main lines are overhead. These may then branch out into secondary lines that are usually buried and supply switchboards. Because the homes are low, single-story structures, buried armored cable is then used from each switchboard to supply a group of homes.

The genset is considered a “consumable”: it easily can be transported elsewhere or exchanged when necessary. A 3,000 rpm single-phase genset is assumed to have a life of 4,000 hours while a 1500 rpm, usually three-phase, genset is assumed to have a life of 10,000 hours. Gensets are usually fueled with gasoline or diesel.

In addition to the genset, the powerhouse contains a power meter and a run-time meter. On occasion, the run-time meter is coupled to a cut-out that trips after a pre-determined number of hours. This is designed to ensure that the community does not fail to remember to pay its obligations, i.e., loan repayments, in addition to those connected with the day-to-day operation of the genset.

Switchboards supply electricity and provide individual protection to groups of homes. They are installed at the geographical center of this group and either placed at the bottom of a distribution pole or in a small masonry structure. Each includes a 300 mA RCD, a capacitor for power-factor correction for the domestic fluorescent lighting loads, a two-pole 10-ampere circuit breaker for each household, and a ground rod connection.

A typical domestic installation includes an outside lighting point, an internal lighting point, and an electric power outlet, although the numbers of power points can be increased. Housewiring is wall-mounted and the outside equipment and the junction box are sealed. Lamps are miniature, uncorrected fluorescent tubes or CFLs, selected because of their long life and low power demand. Power-factor correction is achieved within the switchboards rather than at individual lamps.\* This reduces voltage drop and power losses in the main portion of the distribution system and reduces the demand for current placed on the generator.

If public lighting is provided along the main village streets, an additional conductor may be provided for this purpose. Pole-mounted, power-factor-corrected, watertight 18-W lights in fiberglass-reinforced polyester housings are used. In village squares, where concessions are built of flimsy temporary materials, fluorescent lighting strips are installed on 3-m high, surface-treated wooden poles.

The grounding system includes copper wires running through the foundation of the generator housing and by 2-m ground rods installed at each switchboard. To ensure proper operation of the RCDs, grounding of the neutral in the switchboards is done downstream of the RCD and no grounding is used in individual homes. Protection from electric shock in each home relies on a shared RCD in the switchboard serving that group of homes.

Lightning is a major risk and lightning arresters are installed at the generator and at each down-conductor to the switchboards.

Prior to commissioning the plant, the installation is verified. This involves a visual examination to check that the material complies with the safety standard prescribed, is correctly chosen and installed, and is free from visible damage that could affect safety. The tests cover continuity measurements on the neutral conductor, measurements of line insulation and ground connection, tests of RCDs, operating tests on lights, and voltage measurements at the source and at each switchboard.

Two levels of genset maintenance are envisioned: standard maintenance operations carried out by operations staff and specialized maintenance operations that require specific interventions. The former requires that an operator be trained in routine maintenance and provided with an appropriate stock of consumables (lubricants and filters). At half-year intervals, a visit by a specialist is scheduled, and at least once every year, a complete service is performed in the specialist's workshop.

### ***Project costing and tariff***

To prepare a cost breakdown for the GECO approach, ten villages in the Ivory Coast were studied. The average project serves about 130 households with 3 to 4 power points each, along with public lighting. The cost breakdown (excluding the cost of the genset, which averages \$9,400 per site) is shown in Table 21. This amounts to about \$630 per consumer (household). This cost excludes any taxes and assumes that materials are supplied locally. Procuring materials overseas (exclusive of tax and import

---

\* A capacitor for power-factor correction is usually located as close as possible to the source of the inductive load—the magnetic ballasts in the case of fluorescent lighting. This is to minimize the impact of increased currents on voltage drop and power losses along that segment of the conductor between the inductive load and the capacitor. In the case presented in the GECO project, rather than using a smaller capacitor in each fluorescent unit, a single, larger capacitor is located in the switchboard. However, as is explained on p. 148, when small conductors are used, reactance of the conductor is much smaller than its resistance, and power factor has a negligible impact on percent voltage drop. Therefore in this case, there is no need to minimize distance between capacitor and the ballasts in each fluorescent unit to reduce voltage drop. However, increased power losses are incurred due to the higher currents over this distance; however, this is still low because of the low demand in each home.

duties) results in a saving of more than 20 %. Including taxes would add an additional 20 % to the costs shown.

The still substantial project costs are in part due to the use of quality materials to minimize future costs that would otherwise be incurred for repair and maintenance and to an emphasis on a safe design, with adequate consumer protection. It is expected that future costs will be reduced by 20 to 30 % as projects become more routine, as multiple projects are implemented at the same time, and with the bulk purchase of materials.

In the Ivory Coast, the average operating cost, including fuel, maintenance, and minor manpower requirements (for refueling, generator start-up and shut-down, minor maintenance on the generator set and network) works out to about \$0.50 per month per power point. The cost of fuel, which accounts for about 70 % of this cost, has been calculated on the basis of the delivered cost of diesel at about \$0.50/liter.

The following items are considered in the formulation of the tariff:

- The investment in the mini-grid
- The cost of the generating set
- The operating costs (materials and labor for the day-to-day running of the project)

The precise values of the first two components depend on the size of any grant assistance, the amount of subsidy received, and the interest rate and duration of the loan taken out to cover the balance. If there were no government grant or subsidy and if long-term, low-interest loans were available, an approximate breakdown of the monthly tariff per power point would be as illustrated in Table 22. With each consumer averaging 3 to 4 power points, the tariff per household would amount to roughly \$9 per month. These figures do not include any tax, which would add another 20 %.

In the actual situation, monthly payments are made on the basis of the number of power points in a home, with the rate per point

**Table 21. Cost breakdown for an "average" project with locally purchased materials, exclusive of taxes.**

Description	Costs (US\$)	
	Sub-totals	Totals
Main line		\$13,600
Secondary lines		\$12,200
Primary panels	\$4,500	
Secondary panels	\$4,100	
Buried cable junction boxes	\$2,400	
Grounding and accessories	\$1,200	
Service connection		\$22,000
Domestic installation		\$18,800
Public lighting		\$3,600
Lightning protection		\$2,100
Study and supervision		\$9,800
TOTAL		<b>\$82,100</b>
In-kind local contributions		
Cable trenches	\$8,900	
Holes for pole installations	\$1,300	
Powerhouse	\$1,700	
TOTAL		<b>\$11,900</b>

**Table 22. An approximate calculation for the monthly tariff per power point needed to cover all project costs, with breakdown.**

Item	Amount (US\$)
Mini-grid loan	1.50
Generator replacement	0.50
Operating cost	0.50
TOTAL	<b>\$2.50</b>

decreasing with this number of points.

After the introduction of electricity, the use of batteries, candles, and fuel for lamps continued. Such lighting is still required for occasional use in areas beyond the reach of electric lighting or as a night light in the home after the power is shut off. Batteries are still required for such uses as hunting during the night and for listening to radio during the day. It is interesting to note that the cost of electricity supply generally exceeds the cost of lamp fuel, candles, and batteries that are displaced. Depending on the actual tariff in a particular village, the overall operating cost of electrification varies between 1.0 and 1.3 times the cost of energy supply options previously used.

To cover loan repayments, it is necessary for regular income to be generated from electricity sales to consumers. However, since villagers often do not have regular jobs as is generally the case in urban settings, monetary income to villagers tends to come sporadically, such as when crops are harvested and sold. This could pose a problem to the plant operator who must ensure that adequate cash is available to meet the loan repayment schedule.

### **Conclusions**

Potential advantages associated with the GECO approach include the following:

- By keeping cost lower than conventional mini-grids, it encourages the maximum number of connections, spreading the base over which to recover costs and thereby reducing unit cost.
- Standardizing the design facilitates its replication in other interested villages and reduces its cost. It allows communities to access the benefits of electrification without being at the mercy of national utilities or beholden to national electrification priorities. (However, these projects are still dependent on the whims of outside institutions for access to grants and subsidies.)
- In focusing on meeting lighting and entertainment (radio and TV) needs during early evening hours, it meets the most popular uses of electricity while minimizing fuel consumption and cost.
- By involving the local community, it reduces project cost. At the same time, it frees the electric utility from involvement in small troublesome projects that it cannot effectively implement and permits it to focus on the more profitable efforts in urban and peri-urban areas.
- Implementing a well-designed mini-grid permits easy interconnection onto the grid in the future, permitting the national utility to maximize its return at minimum cost.

But several conditions affecting the viability of this approach must also be kept in mind:

- It requires some level of village cohesiveness and initiative and the presence of one or more individuals who can easily and effectively assume leadership roles. With the conventional approach, the utility is in charge of all aspects of electrification; the consumers' only obligation is to pay their bills.
- An adequate disposable income within the community is requisite. Availability of only seasonal income or inadequate income among some can force the entire mini-grid serving a largely domestic load to shut down. This is a less important factor for a utility serving the national grid because the broader consumer base permits cross-subsidies. Furthermore, the industrial and commercial demand on the national system is more reliable and significant.
- Costs of this approach are nonetheless very high, in fact higher than the cost of the candles, lamp fuel, and batteries previously used, while service capacity and availability is severely limited.



## Appendix 2. Case study: Ban Nam Thung, Laos

### *Project initiation*

In 1991, northern Laos faced a drought that significantly reduced rice yields. To address this shortfall, international aid provided emergency assistance in the form of rice. The village of Ban Nam Thung, located several kilometers to the east of Luang Nam Tha in northwestern Laos, was provided 27 tons of rice to tide it over until the next growing season. A small portion of the rice was donated as a gift to the villagers, while most was placed in a rice bank from which the villagers could borrow as needed. This was done with the understanding that farmers had to eventually return to the bank any rice they borrowed as they produced surpluses. The rice that was returned was eventually sold, generating funds for the village that could be used for a community project. They opted to use these funds to undertake the electrification of their village. An agricultural student temporarily living in the village as part of his field training offered to assist in planning and implementing the project. In 1997, the sum of \$1,700 obtained from the sale of the rice was earmarked for the electrification of the village.

### *Design concept*

Because of the cost of running a diesel genset, it was decided that the plant would generate power for three hours every night to serve basic lighting and entertainment purposes. Power was supplied to nearly the entire village of approximately 140 households. A few decided not to get electricity because of either the inability to pay or the lack of awareness of the technology and the hesitancy to make the commitment. Households were to be charged on the basis of the number and type of end-uses to which electricity would be put.

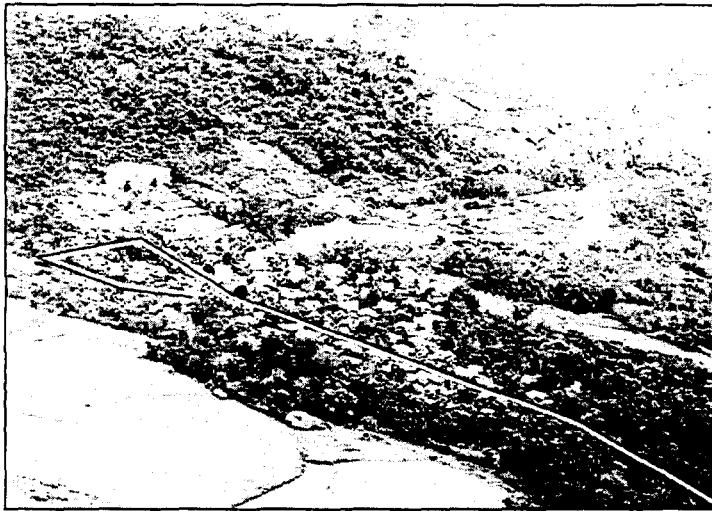
### *Project technical details*

The powerhouse is comprised of a grass-roofed, bamboo structure near the center of the village (Fig. 125). There, a 18-hp Chinese diesel engine drives a 10-kW three-phase generator. From this location, two main lines stretch in both directions, each connected to one of the two phases. Presently, the third phase is not used and the system is not grounded. The longer line is comprised of two insulated 7-mm<sup>2</sup> stranded aluminum conductors extending a total of 800 m, serving most of the main village and a separate village a short distance to the south. The shorter, 300-m line loops around the more heavily loaded, northern end of the village on or near the main east-west road between Luang Nam Tha and Oudomsai (Fig. 126). This is a 2 x 4.0 mm<sup>2</sup>, PVC insulated and sheathed copper conductor. Service drops of 2 x 0.5 mm<sup>2</sup>, PVC insulated and sheathed copper conductor extend in opposing easterly and westerly directions from the main lines, passing from house to house, usually through each home.

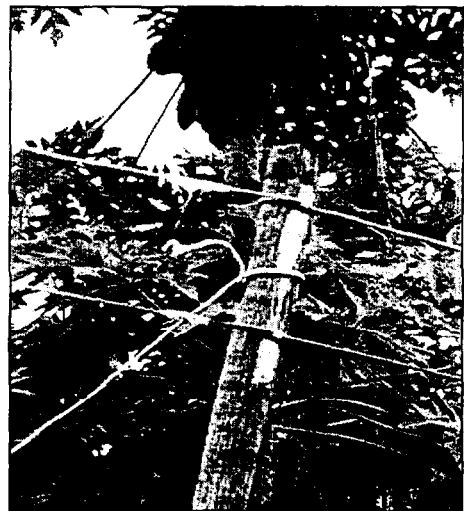
Along the main lines, wooden or bamboo poles set in the ground are used. At times, smaller



Fig. 125. Ban Nam Thung powerhouse and operators.



**Fig. 126. Aerial view of Ban Nam Thung showing the main distribution lines extending in two opposing directions from the powerhouse (black dot).**



**Fig. 127. The two main conductors are supported by wrapping each once around the pole. Also visible is a service drop deadended by wrapping it once around the pole.**

bamboo poles are used to raise the line to provide adequate ground clearance, poles that are simply tied to an post or fence.

Because of the cost that would have been incurred in fixing insulators to each pole, these were not used. Rather, each main conductor was initially simply wrapped around the top of each pole (see Fig. 127). This seemed to work well except in the case where live trees were used as poles. In this case, the growing trees caused the conductor to stretch, breaking the insulation, and giving rise to shorts especially during rains.

At one point when the fuse link tended to blow too frequently (see below), villagers were given the advice that wrapping the conductor around the top of each pole was (inexplicably) causing the problem and that the more conventional, although more involved, crossarm design should be used (Fig. 128). Needless to say, the plant operators found that this intervention did not resolve the problem of fuses blowing and that the first design would have sufficed.

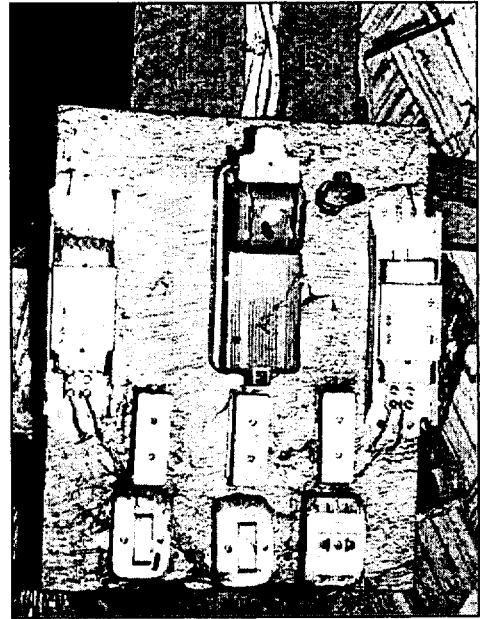
Two approaches were used to connect the service drops to the main line. When the drop consisted of a longer span, the conductor was



**Fig. 128. More recently, crossarms were included to support the main lines that were tied to the crossarm using lengths of string or wire. These proved more complicated to prepare and provided no advantage over simply wrapping the lines around the top of each pole.**

wrapped and tied around the pole to better support the weight of that span. The end of each conductor lead was then wrapped around one of the two main lines and taped. Shorter spans under little tension were directly tied to the main lines themselves. This did not seem to have yet given rise to any problems.

The 2 x 0.5 mm<sup>2</sup> copper conductor used as the service drop was also used for housewiring. The incoming service drop was brought to a distribution board, a wooden board on which were mounted a knife-switch, one to three power outlets, lamp switches, and fuses for each lamp and set of outlets (Fig. 129). Wrapped and taped connections were made on the back of the board that was then wall-mounted. On occasion, the ballast for the fluorescent lighting was also mounted on this board. Wiring clips were used to fix the housewiring to the posts or beams in the home.



**Fig. 129. This service panel include a ballast, fuse, and switch for each of two fluorescent lamps, in additional to a knife switch and fused power outlet.**

### ***Recent operational problems***

During the visit to prepare this study, several observations were made which have general relevance to the design and operation of mini-grids.

In October of 1998, technical difficulties with the project were manifest in different ways. Firstly, the generator overheated and eventually burned out. That problem was "resolved" by purchasing a new generator with a contribution from the European Community foreign assistance program operating in the province, along with villager contributions. Secondly, the fuse for the shorter circuit supplying the northern portion of the village had blown on several occasions. This problem was finally attributed, for some unknown reason, to a faulty knife switch. Whatever the real source of the problem, the villagers had no access to electricity through April 1999. While they were unhappy about this, the lack of technical support in the area led to the delay in trying to resolve the problem.

The final "solution" was to replace the knife switch with a more robust one (i.e., 100-amp switch for a circuit with a maximum current of 18 A). This was coincidentally purchased the day of the visit to finalize this study.

Based on available evidence, the source of the problem seemed to be neither with the generator, with the knife switch, nor with having wrapped the main line around the poles rather than using crossarms (see above). Rather the problems were attributable to the following:

- Overloading the generator. The excessive use of electricity by those living along the road seemed to be supported by the observation made by the plant operators that the generator had been running very hot before burning out. The plant operators acknowledged that one or more households may well have been trying to use irons or other appliances on a circuit which was limited to slightly more than 3 kW for all households. The presence of at least one power point in each home did not help the situation, as this tempted consumers to purchase and plug in

appliances. To limit excess consumption, the plant operators suggested making the consumers aware of the problem, followed by removing this outlet from each home if necessary.

It was also noted that only two of the three phases at the generator output were used, limiting its output to less than two-thirds of its full output. (Unbalance of the generator means that it must be derated in order to avoid excessive heating, see p. 59.) Furthermore, because of the location of the powerhouse and the layout of the principal distribution lines, one phase served a considerably greater number of consumers than the other. Therefore, even if fluorescent lighting had been the only loads on the system, it is likely that relying on only two lines that were also unbalanced could well have overloaded the generator and contributed to its burning out.

- **Incorrect powerhouse fusing.** It was also observed that the fuse wires being used in the knife switches at the powerhouse had ratings larger than the 18 amps that were available on each phase. These excessively large fuses were used in an attempt to "resolve" the problem of fuses blowing too frequently. An attempt to purchase the correct fuse wire in town highlighted one reason for not using the correct fuse wire. Fuse wire available in the couple of shops in Luang Nam Tha either came in spools with no identification or were wrapped in paper with Chinese inscriptions and with a size cryptically identified as, for example, "No. 16". There was no indication of the amperage at which these fuses were expected to blow. Neither the store owners nor the local utility personnel had any idea of the current rating of the various fuse wires available.
- **Consumer fusing.** Rather than using a fuse size in each house solely to protect the housewiring as is conventionally done, it might have been advisable to use a fuse as a current limiter, i.e., to limit the power that a household can draw to perhaps 0.5 A. This would allow, for example, the use of one fluorescent lamp or TV but not permit the use of an iron or other appliance that would unduly tax the system. Unfortunately, the smallest fuse available appeared to be a 10-A fuse.
- **Use of uncorrected ballasts for the widely used fluorescent lighting.** It was noticed that the ballasts were not power-factor-corrected, resulting in a greater current draw than is necessary. When the major part of the load is fluorescent lighting and the capacity of the generator is being approached, as is the case in Ban Nam Thung, it is critical that power-factor-correction be included in each home to make best use of available capacity. Assuming at the design stage that a 20-W fluorescent lamp consumes 0.1 A, which would be expected with a properly corrected lamp of that size, while it actually consumes twice that current, means that the circuit could easily have been overloaded.
- **Running the generator at too high a voltage.** In making trial runs with the new knife switch, it was also observed that the plant operators were running the genset at 250 V rather than at 230 V. Upon questioning, they noted that running the plant at 230 V resulted in inadequate lighting at the end of the line. While running the generator at a higher voltage did "resolve" that problem, it also meant that consumers nearer the generator had access to too high a voltage, which could adversely affect the operation and life of their lights and other end-uses. Running the plant at too high a voltage also caused the generator to generate excess currents, further exacerbating the problem of overloading. (While low-voltage is indeed a problem because it prevents the proper operation of lights and appliances, the proper way of ensuring adequate voltage at the end of the line is to install conductor that is properly sized at the design stage of the project, not increasing the generation voltage.)

If the necessary interventions noted above are adopted, the generator should no longer burn out. Then, the only remaining problem would be purchasing diesel fuel that, due to the rapidly falling value of the local currency, is becoming increasingly difficult for the villagers to cover.

### **Project costing and tariff**

Initial cost was \$1,500 for the diesel genset purchased in China and \$200 for the conductor for the main lines. The cost of the service drop as well as the housewiring was the responsibility of each consumer. The cost of the latter for each household was approximately \$7 for components and \$3 for labor. Although a precise cost breakdown for the original home installation was not available, Table 23 presents cost for similar components, had they been purchased at the time of this study. Note that these are retail costs and that almost all materials come from China. Higher quality materials would be costlier on a capital-cost basis but might prove advantageous if the system is to last.

**Table 23. Cost breakdown for components used for basic housewiring (including a single 20-W fluorescent lamp).**

<b>Component</b>	<b>Cost</b>
Knife switch	1.25
Fuse holder (2)	1.40
Single outlet	.45
Light switch	.30
Fluorescent lamp	
Fixture	.40
Ballast	2.10
Starter	.30
Lamp (20 W)	1.20
Wiring (20 m, 2 x 0.5 mm <sup>2</sup> copper)	2.00
<b>TOTAL</b>	<b>\$9.40</b>

The monthly bill is based on the number and type of appliances in use in the home. Initially, for the most popular end-use—fluorescent lighting—the tariff was set at \$0.50 for each of one or two 20 W fluorescent lamps. Based on operational experience, this was raised to \$0.80 to cover costs. More recently, this was raised to \$1.00 to cover the increasing cost of fuel due to the loss of value of the local currency. In addition to a per-lamp cost, separate tariffs are set for other uses, such as video cassette players and televisions. Each household pays the powerplant operator on a monthly basis and receives a receipt.

Revenues gathered are set aside to meet the follows needs:

- Expenditures to cover the 210 liters of diesel fuel typically used each month.
- Two plant operators at a monthly cost of \$5 each.
- A fund to cover the cost of spare parts and repairs, a fund that is topped up by additional villager contributions if sufficient funds are not available to cover costs that have to be incurred.

### **Conclusions**

This project highlighted the importance for technical backstopping. While the plant operators had basic electrical skills learned on the job, all those involved in one way or another with the project seemed to have difficulty in critically diagnosing problems that occurred. Consequently, measures were taken that corrected nothing but resulted in increased costs and hassle (such as adding crossarms to the poles or buying new and larger knife switches) or that may have exacerbated the problem (such as running the generator at a higher voltage than normal or replacing fuses with ones of higher capacity).

It also pointed to the need for proper planning and designs. In this case, while each household was permitted to use at least one 20-W fluorescent lamp powered by a genset of limited capacity, there was no upper limit on per-consumer usage and no way of enforcing an upper limit had there been one. Also, conductors were not properly sized, with the resulting excessive voltage drop that created consumer dissatisfaction with the service.

And finally, it was clear that project operators must be wary of "answers" given them by those not properly trained. Heeding incorrect advice results in a waste of time, money, and energy.

On the other hand, project implementers have developed a project design that, with few changes, could serve as an example of a basic, low-cost system. Beside the power supply, all that the system involved was wiring for the main distribution lines and service drops—with no other special hardware—and housewiring materials.

## Appendix 3. Case study: Youngsu, Irian Jaya \*

### **Project initiation**

Youngsu is a coastal village located in the eastern Indonesian province of Irian Jaya, isolated from the national power grid, and only accessible by boat or trail. This village consists of 150 homes, a clinic, school, church, and a government office building. The villagers are principally subsistence farmers and fishermen. Sources of income for the village include the sale of fish, coconuts, mangos, and various vegetable crops. Typically, a household would spend up to \$4.50 monthly on kerosene and candles for lighting. The average household wage was estimated to be \$300 annually. In an isolated location with few amenities, the village found it difficult to retain full-time government teachers and clinic workers.

Several other coastal villages near Youngsu had already been electrified using micro-hydropower systems. As a result, the village leaders in Youngsu had a basic understanding of the technology and expressed a high level of interest to implement their own village micro-hydropower project. The installation of a diesel plant was first considered but ruled out due to the high cost of fuel, transportation, and maintenance. Village representatives submitted a formal request for funding to the Development Board of the Provincial Government (BAPPEDA) early in 1993. At this point, Yayasan Usaha Sejahtra Indonesia (YUSI), a local non-governmental organization (NGO) experienced in designing and installing micro-hydropower systems, was contracted by BAPPEDA to survey the site and submit a design recommendation with a budget for the project. In 1994, the village received funding assistance from the provincial government for the purpose of implementing a village micro-hydropower system. YUSI was then contracted to undertake development of the micro-hydropower system with the understanding that the village of Youngsu would agree to provide the required labor, local materials, and land for the project.

YUSI was established in Irian Jaya in 1987 by the World Relief Corporation, with funding from USAID. The facility it operates is fully equipped to manufacture small water turbines and implement village micro-hydropower systems. To date, over 30 small-scale hydropower systems have been installed in Eastern Indonesia by YUSI, resulting in over 40,000 direct beneficiaries. YUSI provides training and direct support of the installed micro-hydropower systems with spare parts and repair, an important element in insuring sustainability of the village micro-hydropower systems.

The village of Youngsu had previously undertaken government-funded projects, which included construction of a suspension footbridge, a medical clinic building, and improvement of village roads. Like all government-funded projects within the village, the village government authority known as the *kepala desa* formally initiated the micro-hydropower project while a representative from BAPPEDA supervised actual implementation of the project.

### **Design concept**

With a drop of 30 m in elevation along a local stream within a few hundred meters from the village, tapping this resource for the generation of power appeared a appropriate source of power for the village. A 12 kW micro-hydropower scheme, using a crossflow turbine fabricated in-country, was constructed to supply the mini-grid and provides three-phase power that was generated, transmitted, and distributed at 380/220 V.

---

\* This case study was prepared by Mike Johnson (minihydro@aol.com).

The valve to the turbine is set to generate any level of power up to its design limit. An electronic load controller disposes of any power in excess of that used by the community by converting it to heat that is dissipated in the water leaving the powerhouse. In this way, a constant load is placed on the turbine, permitting it to operate at a constant speed and frequency (50 Hz). This is the conventional approach to governing a micro-hydropower plant because it is considerably less costly and problematical than using electro-mechanical governors. The only difference with micro-hydropower projects elsewhere is that, in those cases, excess power is generally used to heat water then used by the villagers, such as for washing, rather than thrown away.

Because the village had no experience with electricity prior to the micro-hydropower project, nearly all of the installed consumer loads were for lighting. The typical home in Youngsu is arranged with a porch, living area, cooking space, and sleeping quarters. Because a home normally has no ceiling above the connecting walls, a 40-watt fluorescent fixture mounted high in the rafters will cast light into all rooms. The village clinic, church, and government office used a more conventional approach with several fluorescent fixtures installed as needed. To provide lighting for the village road network, 10-watt fluorescent fixtures were mounted on the distribution poles. The fixtures were mounted on angled wood supports that were covered with galvanized sheet metal to protect the fixtures from rain. Switches, near the base of the pole, but high enough so that children could not reach them, were used to turn the lights on and off.

The plant was generally operated only during the evening hours. It was only run during the daytime if there was a need for power, such as to run a saw, planer, or some other tool.

### ***Project technical details***

After the powerplant, one of the most expensive components of a mini-grid would normally be the poles. Because of the remoteness of Youngsu, transportation adds further to the cost of anything imported into the community. The materials must first be trucked a distance over 100 km from the city of Jayapura to the nearest dock. From the dock, a 3-hour boat trip is required to the village. In addition to the cost of local transportation, costs for materials shipped to the remote province of Irian Jaya are generally higher than the price at their source in Java. These factors were considered in selecting the type and material for the distribution poles to be used.

Three types of poles that had been used previously in other village systems in the country were considered:

- Indonesian-manufactured, galvanized, 80 mm x 6 m, lightweight, steel water-pipe, the upper threaded end closed off with an 80-mm steel pipe cap.
- Steel-reinforced concrete poles, poured upright in place using a wooden form. The square cross-section of 150 mm on a side at the base tapered to 100 mm at the top.
- Locally available ironwood poles.

This first option—using galvanized water pipe for distribution poles in a village system—has certain advantages. With its 6-m length, setting the pole 1 m into the ground still allows sufficient clearance between the conductors and the ground. If the tops of the galvanized pipes have been capped (to prevent the entrance of rainwater that would speed up corrosion of the pole from the inside at ground level) and the buried sections have been coated with bitumen, they have provided years of service in other projects. In projects located in the interior of the country, where materials are typically flown in, galvanized poles are transported in 3-m segments and joined by pipe couplings.



If a pole is located in soil that does not provide good compaction, a concrete support is poured around its base. If a pole requires guying, a single section of ABC is used for the guy, secured through a hole near the top of the pole and attached to a rock anchor buried in the ground. The strength of the pipe is not compromised by drilling 10-mm holes near the top for attachment of cable hangers, streetlights, or other fixtures. Use of galvanized pipes for distribution poles provides a uniform, professional appearance. The chief disadvantage of the galvanized pipe, which is manufactured in another part of the country and shipped across the Indonesian archipelago, is its cost. The cost per pole including the threaded cap, delivered to the village, would have been US\$ 37.

The second option—using poured-in-place concrete poles—requires the construction of suitable forms. Because forms must be left in place for several days for the concrete to cure, multiple forms must be prepared; otherwise, pouring poles would take too much time. For each pole, approximately 0.8 m<sup>3</sup> of good quality, high-strength concrete is required, in addition to a matrix of reinforcing rod around which the concrete is poured. Attachment holes for bolts and anchor wires are provided by inserting pieces of slightly tapered bamboo sections through the forms near the top. When the pole has sufficiently cured, the bamboo can be knocked out, leaving the necessary holes. If the installation crew is experienced and the concrete is mixed properly with good quality aggregate, the results can be good. Conversely, improperly mixed concrete and poor aggregate can result in failure. In addition, an adequate curing time is required for the completed pole. If the conductors are attached and tensioned too soon, the pole will crack. Unit cost of the concrete pole was calculated to be US\$ 34. In this application, there would have been no cost advantage with using concrete as opposed to galvanized steel pole. In addition, cost for the forms and well as for labor and the risk of pole failure ruled out the use of concrete poles.

The third option—using ironwood poles—was chosen for a number of reasons. Youngsu is a coastal village that lies at the foot of a heavily forested mountain range. Ironwood suitable for distribution poles is in abundance and can be used under government regulations that allow trees to be harvested for use in local infrastructure and community development projects. Although ironwood is a term used to describe a number of tree species, the particular type of ironwood commonly used in the area is a dark, dense, naturally preserved material known as *kayu besi*. It is used for supporting piers for village homes and for other applications where the wood is buried. Posts installed by the Japanese during World War II are still standing. The ironwood tree itself can be up to 1 m in diameter. These poles may be drilled in the top section for attachments and can be directly buried, although a coating of bitumen below grade will further preserve the pole. Normally, the pole is buried about 1 m and well tamped for stabilization. No costs were associated with the ironwood poles for the Youngsu project, since the village had agreed to provide all local materials. The 1,100 meters of single- and three-phase distribution cable required 55 poles, which were set at an approximate spacing of 20 m.

Although some low-voltage village distribution systems use bare conductors, secured to insulators on the pole, it was decided that both single- and three-phase conductors for the distribution cable would be aluminum ABC that is commonly used by the national electric utility, PLN. This type of cable is manufactured in Indonesia and is ordered from Jakarta or Surabaya on large spools. In the case of the Youngsu installation, as with other village electrification projects, the insulated conductors provide an added measure of safety for villagers who are as yet unfamiliar with electricity and associated hazards. Secondly, stringing ABC on the poles requires only a simple hanger per pole rather than several insulators and mounting hardware used with open conductors. The cost of ABC is somewhat more than that for open conductor, although this difference is somewhat reduced because of the lower labor costs for installation and the elimination of insulators and most poletop hardware.

Both 2-conductor ( $2 \times 35 \text{ mm}^2$ ) single-phase and 4-conductor ( $3 \times 50 \text{ mm}^2 + 1 \times 35 \text{ mm}^2$ ) three-phase ABC were used. To support this cable, a 10-mm hole was drilled 100 mm from the top of each of the ironwood poles. Through this hole, a 10 mm x 120 mm bolt was inserted, and this was used to attach a simple "J" hanger fashioned from a length of 3 mm x 30 mm iron strap (Fig. 130). In the case of the three-phase cable, only the ground conductor was hung in the hanger while for the single-phase cable, one conductor was hung in the hanger. A short piece of insulated copper wire was used at times to secure the conductor to the hanger in order to prevent movement of the cable and the resulting wear of the insulation. It is not known whether, over time, any damage has occurred to the insulation or conductor being supported by a hanger of this design.

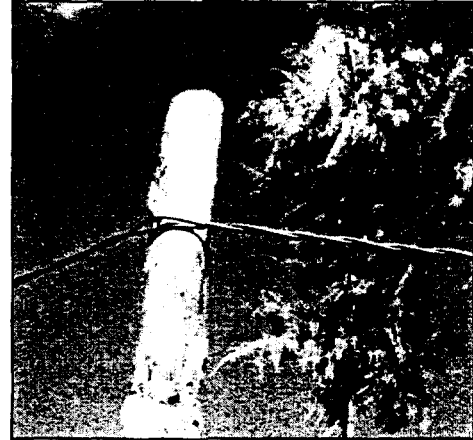
Where a single-phase cable branched off the three-phase cable, the single-phase cable was deadended on the pole carrying the three-phase ABC. A wedge clamp was used to deadend the neutral conductor of the single-phase line. This device, which has a tapering groove and wedge, is attached to the pole with an eyebolt. The cable is inserted into the groove and is held in by the wedge when tensioned. To make the connection, the conductors were bared and joined with a single galvanized steel U-bolt cable clamp of appropriate size. Prior to joining, the cables were given a good coating of an anti-oxidation compound.

The same method was used to join lengths of conductor. The two lengths of conductor to be joined were overlapped about 100 mm and the insulation removed from this overlapping section. These were joined together with two U-bolt clamps after cleaning and the application of the anti-oxidation compound. On stretches with multiple conductors such as along three-phase lines, the connection on each line was staggered about 300 mm to avoid shorting between conductors.

These methods for making connections and splices use a low-cost, readily available piece of hardware—a U-bolt clamp. While they seem to have provided a good electrical connection and have stood the test of time in the case of the Youngsu project, use of this hardware is not generally recommended for these purposes.

Where a service drop was provided from the ABC to the building or home, an insulated  $2 \times 10 \text{ mm}^2$  copper conductor was used. This smaller cable was attached to the aluminum distribution cable using U-bolts as previously described. Typically, the cable was then attached to the building by securing it to the outside wall or a convenient surface with one or more heavy staples. While it is not proper practice to join conductors of dissimilar metals (copper and aluminum), a generous coating of de-oxidation compound was used with good results. Because the service drops were relatively short and lightweight, they were attached directly to, and supported directly by, the ABC conductor and no attachment was used to deadend the service drops to the pole. It is unknown whether the use of staples or the direct attachment of the service drop to the ABC cable has led to fatigue of the metal due to swinging of the conductor and eventual breaking of the joint as might be envisioned.

The Youngsu system does not use individual kilowatt-hour meters; rather, each residential customer is billed a monthly flat rate and allowed a maximum total connected load of 40 W. Nearly all of the homes have installed florescent lamps rather than incandescent light bulbs. Although incandescent light fixtures



**Fig. 130. Homemade "J" hangers are used to support the insulated ABC.**

(Photo credit: Mike Johnson)

and bulbs are less expensive, their use was discouraged because of inefficiency and the necessity of frequently replacing bulbs.

Each home was supplied with an Indonesian-manufactured single-pole circuit breaker. The smallest size that could be procured in quantity was 0.5 amp. Although this allowed the consumption of more current than that permitted by the 40-W limit, the breakers at least provide protection against short circuits and the use of high-current loads such as electric irons. At another village installation where breakers of a higher value were used, a government schoolteacher ironing his trousers in the evening regularly browned out the village. The Indonesian breakers were supplied with a mounting plate and plastic cover. The breaker was mounted close to the incoming conductor, usually on the home's porch, with a drip loop provided to keep water from running into the breaker. Because the electrical system is floating, no grounding electrodes are used.\* From the breaker, 2-wire indoor-type insulated wire connects the lamp, switch, and a single outlet.

The honor system was expected to prevent individual consumers from drawing more than 40 watts of power from the distribution system. In practice, however, many homes exceeded this limit and eventually the cumulative effect resulted in the turbine shutting when the frequency dropped below 45 Hz. This would normally occur during the dry season when the turbine was running at part load due to lack of water. At this point, the *kepala desa* would police the consumers and attempt to enforce the 40-watt rule. Villages in Indonesia are prone to operate by consensus, where pressure to conform corrects behavior which is contrary to the community interest. In time, after a period of trial and error, the village adapted its energy usage to availability of power.

Apart from residential use and lighting for the few community buildings, some of the more enterprising villagers discovered income-generating opportunities made possible by the micro-hydropower system. The use of a few incandescent lamps permitted small poultry businesses to provide warmth for raising chicks, leading to considerable success in an otherwise damp environment. Some woodworking tools, particularly electric hand-held wood planers are being used to work rough cut boards into finished lumber. The government clinic also installed a small refrigerator, which is used to preserve medical supplies.

Because the operation of the electronic load controller was sensitive to lightning, lightning arresters were included at the powerhouse.

### ***Project costing and tariff***

Table 24 provides the cost breakdown for the mini-grid portion of the project. One factor that reduced project cost was reliance on local materials (ironwood poles, sand, gravel, and rock). Labor provided by the villages on an in-kind basis reduced cost. Electric service was provided up to and including the breaker. The consumer was responsible for purchasing and installing the housewiring, the 40-watt fixture, and an outlet, if desired. YUSI provided electricians to supervise consumer installations.

In addition to this cost, the cost of the micro-hydropower systems totaled about \$19,000.

Individual households were responsible for covering the cost of all materials used for housewiring listed in the Table 25 (except the breakers) and labor. This amounted to about \$22.

---

\* This approach was adopted to be consistent with what seems to be the approach typically used by PLN, the national utility, for low-voltage distribution.

**Table 24. Cost breakdown for the Youngsu mini-grid serving 150 homes, a clinic, school, church, and government office building.**

Items	Quantity	Unit cost	Total
Three-phase ABC	600 m	4.40	2,640
Single-phase ABC	500 m	2.40	1,200
Service wire	1,000 m	1.60	1,600
Housewiring (see below)	150	19.70	2,950
Village lighting and switches	24	12.00	290
Circuit breakers	5	5.50	30
U-bolt clamps	180	.60	110
J hangers	60	.40	20
Bolts, nuts, washers	80	1.60	130
Friction clamps	15	2.70	40
Concrete	35 40-kg bags	6.80	240
<b>TOTAL</b>			<b>US\$ 9,250</b>

The provincial government funded the capital cost for the project. Consequently, revenues to repay this cost were not required. However, to cover the cost of the operator as well as to have a reserve to procure materials for the maintenance of the system, a monthly tariff per consumer was set at Rp. 5,000, which was equal to \$2.30 when the project was commissioned in 1994. Given that the cost of kerosene typically used for lighting was nearly double this figure, electrification with its many additional uses and benefits was a bargain for the villagers. Furthermore, recurring costs should be minimal, at least in the first years of the project, and if monthly fees continually to actually be collected and accounted for, adequate funds should be available to cover these plus the operator's wages. However, it is clear that this project, as with most infrastructure projects, is dependent on external funding and it is not clear whether such a project could be implemented with costs solely covered with funds generated by the local beneficiaries, even if credit on reasonable terms were available.

In addition, the *kepala desa* was responsible for collecting the monthly user fees. This type of accounting is not transparent and often results in funds disappearing or being used for some other purposes. Yet in

**Table 25. Breakdown of housewiring costs.**

Component	Cost (US\$)
Circuit breaker	\$5.50
Fluorescent unit, 2 x 20 W	6.80
Outlet	1.10
Switch	1.40
Wire (20 m)	4.50
Staples	.40
<b>TOTAL</b>	<b>\$19.70</b>

the case of Youngsu, there was no alternative other than financial management by the local government authority.



## **Appendix 4. Case study: El Limón, Dominican Republic\***

### ***Project initiation***

The village of El Limón is located in the arid southwest mountains of the Dominican Republic (DR), two hours west of Santo Domingo. Nearly seventy households eke out a marginal living growing onions, eggplant, and other low-value cash crops. Like most Dominican villages off the infrastructure corridors, El Limón has little prospect of being connected to the national electrical grid in the foreseeable future. But unlike the typical Dominican village, El Limón is a highly organized community with a strong history of participation in self-help projects. For the past 25 years ADESJO, a regional community development organization in the nearby city of San Juan de Ocoa, has been providing technical and financial support for such projects as the construction of the road, school, irrigation system, water system, and agricultural improvement. In each case, the community has assimilated new skills and moved rapidly toward self-reliance. The result has been a community with an atypically high degree of self-confidence and project management skills.

El Limón's experience in building and operating its irrigation system provided the base for the electrification project. When construction of the irrigation system began in 1991, the community could only provide manual labor. Within a few years the villagers had acquired the technical and management skills necessary to maintain (and extend) the elaborate gravity-fed PVC pipe irrigation system. A very effective system of work brigades evolved, headed by a five person committee; each member was responsible for one day of the workweek. This approach is now being used to extend the irrigation system, as well as for other community projects, including the electrification effort and the fairly extensive repairs needed after Hurricane George.

The Irrigation Committee is the village's most sophisticated management operation. It allocates water, schedules water use (which involves moving sprinklers every two hours around the clock), and makes sure that all members of the irrigation project make their payments to cover the original \$75,000 construction loan. The actual handling of money and the record keeping is done in the nearby city of Ocoa by ADESJO, which managed the loan and the initial construction. Fifty-nine families participate in the irrigation project and each is responsible for making quarterly payments timed with their quarterly harvests. Most own from 1.0 to 1.5 ha and pay \$170 to \$250 quarterly. Most people have been able to keep up with their payments.

The electrification of El Limón grew out of a 1996 regional workshop on very small hydropower systems presented by the EcoPartners Project (a Cornell University affiliate), in cooperation with ADESJO. The workshop visited El Limón as a field exercise in system design and demonstrated a 12-volt turbine/generator unit to the community. Response was enthusiastic, and a turbine was eventually installed at the village school, with extensive community participation. Residents expressed a very strong interest in villagewide electrification powered by the irrigation system. The system described here was designed to address the limited water resource available. Technical support has been provided by EcoPartners, logistic support by ADESJO, and labor by the community.

The implementation approach was unusual, in that the electrification was integrated into a much broader village development project. The expatriate project implementer resided in the village on a half-time basis over the two years of the project, with much time spent on other activities. A major project priority

---

\* This case study was prepared by Jon Katz (jgk5@cornell.edu).

has been transferring technical skills into the community, and residents learned construction, wiring, electronic assembly, and computer/video documentation skills.

The project was officially inaugurated the beginning of April 1999 although portions of the village had begun receiving power earlier. A total of 56 households now receive electricity and a few more will be added later. All have one light and a second will be installed shortly.

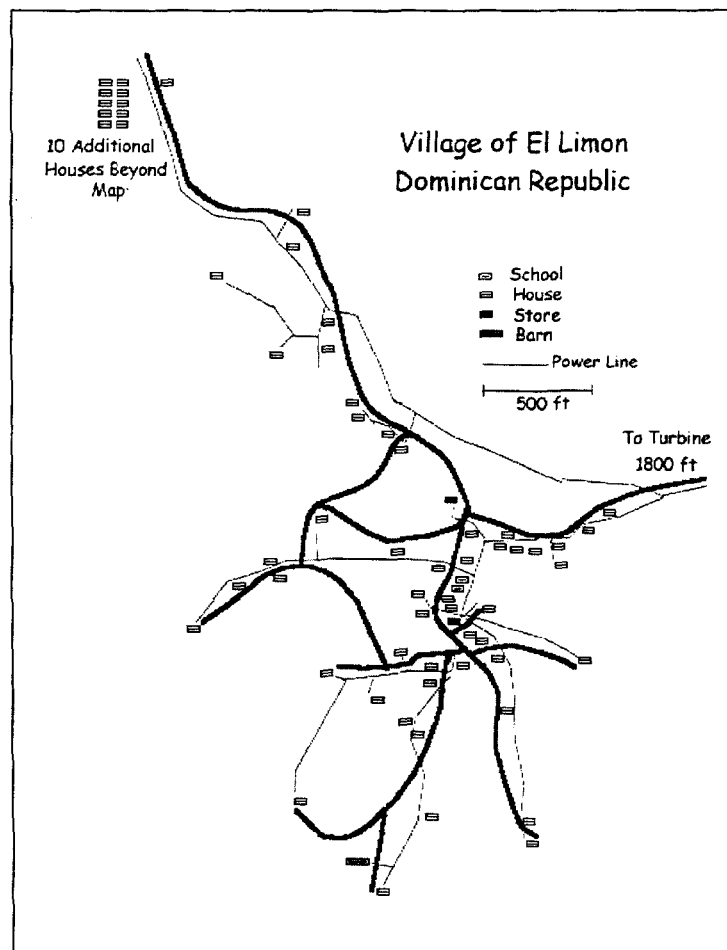
### **Design concept**

As the source of power, a 2.5 kW micro-hydropower plant was built along an irrigation pipeline to harness the excess energy in the water as it descends the final kilometer of a 6 km PVC pipeline. A low-cost, 240-V induction motor, with an appropriate electronic load controller, is used as a generator to supply single-phase power to the mini-grid.

The distribution system transmits the power about 600 m to the village and distributes it around the village, supplying homes as far as about 1 km from the village center (Fig. 131). Because of the limited hydropower potential of the irrigation pipeline and the need to serve 60 households and to provide roughly 200 W of power to the school for lighting and the computer center, the power available to each household is initially limited to no more than 35 W. This might be altered somewhat as actual operational experience is gained. Potential

consumers were made aware that this was only adequate for a couple of compact fluorescent lights and a radio or tape recorder; that a small 12-V television could be used if lights were turned off; and that refrigerators, irons, and hair dryers could not be used at all. While many residents would have preferred more electricity, explaining that the energy available 24 hours a day would equal the output of three photovoltaic panels quieted all further objections. Only one family in El Limón has been able to afford a private single-panel system, and a three-panel system is considered a great luxury

After passing through the turbine, water is fed back into a network of pipes to irrigate the land at lower elevations. Because the irrigation system runs around the clock, electricity will be available at all times. The energy calculation of 2.5 kW was based on the 6 l/s (liters/second) flow observed over a typical year. However, 1998 was a



**Fig. 131. Layout of the el Limón mini-grid.**



drought year and the water flow dropped to about 2 l/s. This was inadequate for irrigation as well as electricity generation, and the community recently obtained the pipe necessary to extend the system to the next stream, whose flow was measured at 12 l/s during the drought. The irrigation extension should assure a minimum of 2.5 kW at all times and may allow for some expansion.

A conventional distribution system in the DR distributes electricity to and around the village at a medium voltage and then steps it down to 120 V, the nominal residential voltage in the country. In this project, the decision was made to generate and distribute power at 240 V for the following reasons:

- This voltage is sufficiently high to permit the use of reasonably priced conductor for transmitting power from the powerhouse to and around the community while restricting the maximum voltage drop to 5 %.
- It somewhat reduces the danger of shock and makes the system easier and safer for village residents to maintain.
- Power can be generated at the "transmission voltage" of 240 V, eliminating the losses and the expense associated with a step-up transformer that would otherwise have been needed at the powerhouse.
- The absence of 240-V lamps and appliances on the local market makes it difficult for end-users to illegally tap the power line, a common practice in the DR.

While 240 V is available around the village, consumers only have access to low-voltage direct current (dc). To convert the distribution voltage to 12-V dc for domestic use, a converter—a small transformer, rectifier, and filter capacitor—that is usually pole-mounted outside each home is used. The design of system components within the home parallels that used for solar home systems (SHSs)—dc wiring, fluorescent lighting, and a connection for radio or TV. Also like SHSs, for those who wish to make the additional investment in a battery, it would appear that power could be stored, if the available voltage is adequate to properly charge lead-acid batteries. This has yet to be attempted. But unlike the solar option, the power of 35 W per household will be available 24 hours per day, making the battery only necessary to operate larger loads. In fact, only a few batteries are likely to be installed, reducing both system life-cycle costs and toxic pollution associated with the uncontrolled dumping of lead-acid batteries. Twelve-volt appliances are increasingly readily available in the DR because of the popularity of SHSs.

This approach has the following advantages:

- Availability of only 12 V dc in the home reduces the potential for shock and fire hazard and facilitates maintenance by local residents who have little prior experience with electricity.
- The use of a converter (necessary to convert electricity available at 240 V ac outside the home to 12 V dc within the home) and breakers in a steel box for each consumer sets an absolute limit on the current that can be drawn, even if the limiting device in the home is bypassed. This might also be possible with an ac system but finding a low-cost, low-current (i.e., about 0.07 A) circuit breaker may be difficult.
- Should battery-charging prove practical at the voltage available from the transformer/rectifier, this would permit significantly more energy to be available to the consumer.
- No noticeable change in brightness is apparent in the compact fluorescent lamps over a considerable voltage range (8 to 15 V).

Disadvantages of this approach included the following:

- Increased costs, complexity, and chance of failure are associated with the converters.
- Incurring losses estimated at 10 W per household is also a significant disadvantage when available ac power is limited to no more than 35 W per household. These losses are typical of the general-purpose transformers donated to the project. The use of high-efficiency transformers could decrease these losses.

### ***Project technical details***

The 135 poles required for the project were fabricated on-site of steel-reinforced concrete. The 20-foot (6-m) poles have a square cross-section of 6 inches (150 mm) at their base, tapering to 4 inches (100 mm) at the tip. Although at first reluctant to transfer his skills, the mason who designed the poles did eventually teach the local residents how to form and wire the reinforcing steel, and production of the poles continued without his involvement. Reinforcement consists of four 3/8-inch (10 mm) rods running the length of the pole, tied by square rings of 3/16-inch (5 mm) every 6 inches. Forms consisted of wooden walls nailed to a wood platform. Four poles were made at a time, at the rate of 8 per week. As is customarily the case, concrete was mixed on the ground. The use of ungraded aggregate produced a low-strength concrete, but there was little problem with breakage of the cured poles. To facilitate the mounting of insulators, two (later four, at right angles) pieces of 1/2-inch (13 mm) plastic water pipe were included in the pole to provide through-holes. The material costs for the poles (cement, reinforcing steel, and aggregate) averaged about \$40 per pole.

Moving the poles, which each weigh over 500 pounds, proved to be a major problem. To facilitate this task, a handcart was built of steel box tubing and automobile wheels. Despite the cart, moving the poles to locations away from the roads proved difficult. In some locations, it was necessary to carry the poles with teams of 12 workers. One conclusion drawn from this experience was that it would have been wiser to choose longer, less direct transmission runs that followed roads wherever possible.

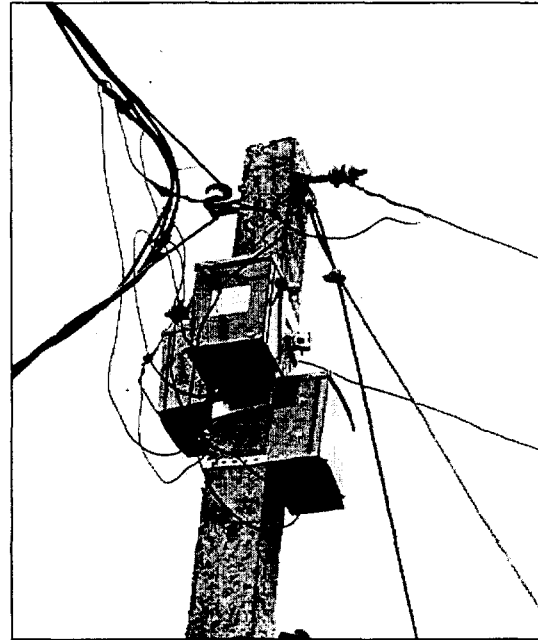
Holes were dug using basic hand tools. The poles were raised using a variety of pulleys, poles, and gin poles. Differing conditions required a constant reinvention of approaches and techniques. While never easy, and often hazardous, the process became less formidable with practice.

Where necessary, poles were guyed with the usual 3/8-inch (10 mm<sup>2</sup>) high-tensile cable. This cable was tied around an anchor made of meter-long lengths of concrete pole castoffs buried a meter underground.

Because of cost-savings resulting from quantity discounts, only two sizes of conductor were incorporated in the system, one for the multiplex and one for the copper. This meant that the longer, more heavily loaded "transmission" runs used #2 (34 mm<sup>2</sup>) aluminum secondary cable in duplex, triplex, and quadruplex combinations (one, two, or three insulated aluminum conductors, respectively, wrapped around the neutral ACSR conductor) to keep voltage drop within acceptable limits. For example, the initial run was comprised of two lengths of triplex or a total of six conductors. As the line approached the village and split off into two directions, a transition was made to one quadruplex and one duplex cable.

Where the multiplex ended, hard-drawn solid #12 (3.3 mm<sup>2</sup>) copper conductor with ultraviolet-resistant high-density polyethylene (HDPE) insulation, rather than off-the-shelf indoor wiring, was used to extend further within the village. This wire is mechanically much stronger than indoor wiring, and the insulation is more durable and tougher for outdoor service. This conductor was specially fabricated at a cost only slightly higher than indoor wiring. The sizes of the conductors used were calculated using a spreadsheet developed to calculate voltage drops and costs of conductor made of differing materials and with different sizes.

The conductors were attached to the poles on 2.5-inch (60 mm) porcelain spool insulators mounted on 1/2-inch (13 mm) threaded rod. Two-inch-long (50 mm) spacers cut from 1/2-inch iron pipe were used between the insulators and poles. Washers were used at all porcelain interfaces to prevent chipping or cracking. Where the conductor made a significant angle, right-angle brackets were used to mount the spool insulators vertically, on the inside of the bend, and no spacers were necessary. Short lengths of the insulated copper conductor were used to attach all the conductors to the insulators. Where multiplex conductor was used, the bare neutral conductor was separated from the insulated conductors in the bundle, placed over the top of the insulator, and tied to it with the insulated wire. This attachment design is secure, but will allow the wire to separate from the insulator under high stresses without breaking.



**Fig. 132. Typical poletop configuration with three pole-mounted power supplies.** (Photo credit: Jon Katz)

Figure 132 shows a section of the main quadruplex line passing through in the upper left and a copper conductor extension of the 240-V distribution line leaving at the right (upper conductor). A dc line to supply a home leaves from the right (lower conductor). The two wires to the lower right are guy wires. A homemade right-angle bracket supports the spool to which the messenger of the quadruplex is attached. In this case, the spool insulator is cantilevered, somewhat reducing its strength. A stronger configuration that should be used for this purpose is a swinging clevis shown in Fig. 65. A support clevis should preferably be used to deadend the line extension leaving at the upper right, replacing the upset bolt actually used. An upset bolt is typically only used to support a conductor that leaves the spool insulator about perpendicular to the axis of the insulator. As shown in the figure, the conductor as installed would tend to slip off the spool over time or fracture at the point where the conductor goes over the lip of the insulator if the angle is too great.

In September 1998, Hurricane George's center passed about 40 miles from El Limón. No poles failed, but the high winds (about 160 km/h) tilted about five highly exposed poles to the extent that they had to be realigned and, in some cases, guyed. In several locations, wires separated from the insulators but were undamaged and easily reattached. Only one copper conductor was broken by falling tree limbs.

A copper conductor is also used for the initial portion of the service drop from the distribution line to the converter box and is joined to the main line with a split-bolt connector. Where the distribution line is aluminum, a tin-plated split-bolt connector with a separator is used to eliminate copper-aluminum contact. Anti-oxidant grease is applied before joining the wires, and the joint is well covered with rubber splicing compound and wrapped with vinyl tape. (See p. 104 for discussion of connectors and problems with aluminum-copper connections.)

The distribution system supplies 240 V ac, with one side grounded. The 12 V dc supply to each home consists of the following items:

- A 0.63-ampere MCB on the 240 V side to protect the system in case of diode or transformer failure.
- A converter (consisting of a transformer, an encapsulated rectifier bridge, and computer-grade filter capacitors rated at 20,000 microfarad, 40 V dc).
- A 6-ampere, dc self-resetting MCB on the dc side transformer in case the manual breaker in the house is bypassed.

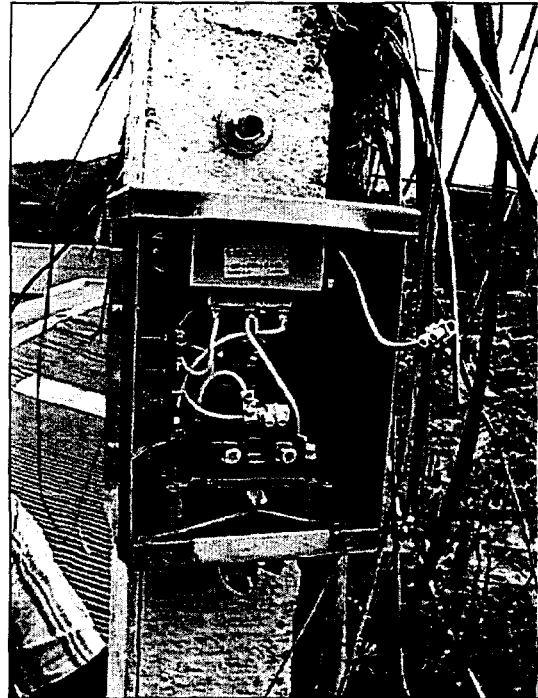
For both of the above MCBs, thermal units were selected to keep costs down. All the components for each home are mounted in one ventilated, waterproof steel box, generally strapped to the pole nearest the home (Fig. 133). In the case of sturdier homes, the box may be mounted on the outside of the home. Given the social structure in the village, tampering is not expected to be a problem; otherwise, these boxes could be sealed. Within the home, the principal power-limiting device is a wall-mounted, 3-ampere manual (3 A x 12 V = 36 W) reset circuit breaker. The box can be sealed to prevent the consumer from bypassing the breaker if that should prove a problem.

If the homes are further than about 10 m from the pole, two lengths of the insulated #12 copper conductor serve as the service drop from the pole to the home; otherwise, #16 (1.3 mm<sup>2</sup>) flexible duplex (lamp) cord is used.

This flexible cord is also used for internal housewiring. Two 10-W compact fluorescent lamps with high-quality wall switches are provided for each house, as is a connector to power a radio or small TV. For radios requiring other than 12 volts, converters designed for use in automobiles are widely available. A few households will probably decide to incorporate a battery for the occasional use of higher wattage appliances. To prevent tripping the 3-A breaker in the house due to the high current draw of discharged batteries, a current-limiting device will be supplied to these households. This will probably be a power-transistor-based series current limiter.

Lightning is not expected to be a major problem, since most of the distribution system is in relatively low areas. However, as a precaution, each converter has a MOV (metal-oxide varistor) spike protection arrester between the phase and neutral conductors, and the neutral conductor at about 20 poles with converters is grounded using with 8-foot (2.5 m) galvanized-steel ground rods. The few poles in exposed locations are fitted with lightning rods. The powerhouse end of the transmission line is also protected by a lightning arrester.

Back at the powerhouse, the turbine is protected by a 10-ampere magnetic circuit breaker. Each of the three branches of the system is provided with a 5-ampere thermal circuit breaker at the powerhouse, which also allows powering up the system in stages. If startup outrush currents prove to be a problem,



**Fig. 133. Each home is supplied by dc power from a pole-mounted power supply.**  
(Photo credit: Jon Katz)

several solid-state time-delay relays will be installed in various system branches to provide a more gradual startup. This has not yet been a problem.

For safety purposes, the use of RCDs in the powerhouse was considered, but it was decided that multiple grounding of the system, which is not compatible with use of RCDs at that location, provides a higher degree of safety. Also, nuisance tripping of any RCD used, because of leakages along the long runs, might also be a problem.

### **Management and human resources**

Before work started, the project was brought to the village's governing town meeting. After extensive discussion, the village formally reached consensus on making the electrification a community project. Each of the 65 households was required to contribute one day of work per week. Some individuals worked much more, and several households ultimately failed to contribute significant labor. Two key individuals took on personal, long-term responsibility for completion of the project. One concentrated on the poles and distribution wiring and the other on the electronic assembly of the fluorescent lamps and converter units. The project was completed in about 18 months. The largest part of the work, by far, was transporting the aggregate, fabricating the pole, transporting them, and then setting the 135 reinforced concrete poles (Fig. 134). While at times the idea of a lighter, more easily made pole seemed very attractive, the reinforced cement poles proved their strength during the hurricane.



**Fig. 134. Despite the use of a cart expressly built for this purpose, difficult terrain still made the task of transporting concrete poles difficult. (Photo credit: Jon Katz)**

Both the community and the project implementer found the process of electrification more difficult and time-consuming than expected. The single largest problem was the unanticipated difficulty of working with the concrete poles. There were also changes from the original plan that added substantial work. Just before construction began, the powerhouse site had to be moved from the village about 600 meters up the valley because of a new area which was to be irrigated. Also, residents were very involved in day-to-day design issues and opted for a more durable system. Fewer trees, and therefore more poles, were used than originally anticipated, and a concrete powerhouse much more elaborate than the simple shed originally envisioned was constructed. Other delays were unavoidable. Funds for the distribution wire and materials arrived almost a year later than expected, and Hurricane George, while doing little physical damage to the system, diverted labor to repairs and replanting.

In this project, the organizational strength and motivation of the villagers of El Limón were critical to meeting the challenges they faced. Many residents felt that, at least until a less labor-intensive alternative to concrete poles is found, many communities would have difficulty carrying this type of project to completion with their own resources.

Outside resources were also critical to project success. The EcoPartners Project coordinator spent half of the two-year project period in El Limón, although much of his time was dedicated to other projects in the community. Institutional connections were very important too, with Rotary International providing about one third of the materials, as well as a skilled volunteer for two months.

**Project costing and tariff**

The cost incurred in the construction of the mini-grid portion of this project is broken down in Table 26. In addition, an additional \$4,200 was more or less evenly split between the powerhouse and the turbine and controls. Most of the cost of the penstock (the pressure pipe) was covered by the irrigation project. Otherwise, the cost of the unusually long (6 km) PVC pipe would have added \$10,000 to the cost of the project. In addition, there were contributions of food, community labor (estimated at 7,500 hours), and technical assistance (estimated at 1,500 hours).

**Table 26. Cost breakdown of the mini-grid.**

Description	Cost	
	US\$	%
Transmission wire	3,500	12
Distribution wire (#12 copper)	2,400	8
Distribution materials	1,500	5
Poles (135 6-m concrete)	5,400	19
Lighting	3,500	12
Misc. electrical supplies	1,500	5
Converter units	1,400	5
Transformers for above (donated)	1,000	3
Miscellaneous material	1,000	3
Tools	500	2
Shipping	1,000	3
International transportation	4,800	17
Local transport	300	1
Telecommunications	500	2
Administration	600	2
<b>TOTAL</b>	<b>\$28,900</b>	<b>100 %</b>

For several reasons, it was initially decided to seek donations for the capital costs of this project:

- The system design was very innovative, and it felt inappropriate to ask the community to pay for an experiment that might not yield expected results.
- Loans were unlikely to be available for an unproven design.
- The community had minimal cash resources.
- The community had committed to contributing a significant amount of labor.
- Donation of capital funding was available from the United Nations Development Programme-Global Environmental Fund and from Rotary International.

In addition, the community will be responsible for operation and maintenance of the system. The Electricity Committee will set a monthly fee to cover regular maintenance: cleaning filters, periodic turbine bearing replacement, lamp replacements (10,000-hour life), and repairs. Residents were involved in every phase of construction and are already prepared to perform most of the maintenance and repairs themselves.

The tariff is expected to be minimal, about \$2 per month, approximately the same as that typically spent for kerosene for lamps. Because project costs were covered from various external sources, the monthly

tariffs are expected to cover the cost of materials such as bulb replacement and turbine bearings and the cost of the plant operator. To ensure payment, the Electricity Committee has decided to require a written agreement with each household before installing the housewiring. At present, nearly 60 households (all in the village except for the four houses located outside the present service area) have access to electricity.

### **Conclusions**

Response from the community has been enthusiastic, both verbally and in terms of labor provided, and this forebodes well for the continuation of the project after it has been commissioned. But it is too early to know how diligent the consumers will be about monthly electricity payments. Electricity, even in limited quantities, is extremely important to most residents, both practically and as a symbol of development.

In the process of implementing this project, lessons were learned:

- Everything takes longer than one expects.
- Seek out individual residents who will commit to the project as a personal responsibility.
- Use packaged subsystems wherever possible (particularly the turbine and controls).
- Place as much emphasis on teaching skills as on getting the work done.
- Bring in skilled volunteers when possible.
- With a project of this complexity and this degree of community participation, extensive technical support is needed. Having someone who understands the technology available to initiate each phase of the work and to be on-call at other times is essential.

But questions still remain:

- Will the system operate reliably and satisfactorily under actual loading? Will reliance on the use of dc at the consumer level prove its worth or will unexpected problems arise?
- Given the fixed and limited power available, how will the community deal with load growth in the village?
- Will all villagers regularly pay the agreed-upon tariff on a continuing basis and will this tariff generate the necessary revenues?
- Will the work of operating the system be distributed equitably, or will the burden fall on the village activists, to the point that over-reliance on a few puts the system in jeopardy over the long term?
- What level of technical and financial assistance would be required to implement this project elsewhere and what implications does this have for project replicability?





## Appendix 5. Calculating required pole diameter

Chapter VIII includes a simplified equation establishing the relationship between the span supported by poles to the circumference of the pole at the ground line to ensure sufficient strength to counter maximum expected wind forces. A more complete form of the equation is derived below. Simplifying assumptions made which permit the use of the simplified equation are also noted.

The total force of the wind acting on the  $n^{\text{th}}$  conductor  $F_n$  is transmitted to the pole at a distance  $h_n$  (m) to the pole's ground line and creates a moment  $M_n$  (N·m) which is equal to

$$M_n = F_n h_n = 0.05 V^2 \left( \frac{L_1 + L_2}{2} \right) d_c h_n$$

where

$F_n$  = force (N) on pole due to  $n^{\text{th}}$  conductor

$V$  = design wind speed (km/hr)

$L_1, L_2$  = spans lengths (m) of either side of pole as shown in Fig. 43 (see above)

$d_c$  = diameter of conductor (m), with insulation

$h_n$  = height (m) of the insulator (supporting the  $n^{\text{th}}$  conductor) above the pole's ground line

The total force of the wind blowing on the pole itself also creates a moment  $M_p$  (N·m) which is obtained by integrating the pressure along the pole (i.e., to make up for the fact that the pressure acting on the pole at the tip has a greater effect on the bending moment on the pole than the pressure acting near the ground). This moment is approximately equal to

$$M_p = 0.05 V^2 \left( \frac{d_g + 2 d_t}{3} \right) \frac{h_p^2}{2}$$

where

$h_p$  = height of pole (m)

$d_g$  = pole diameter (m) at its ground line

$d_t$  = pole diameter (m) at its tip

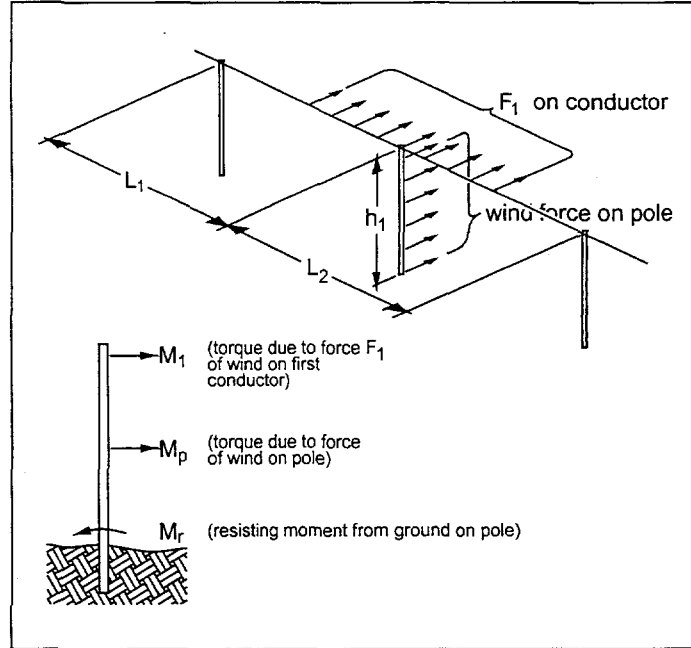


Fig. 43 (repeated from Chapter VIII). Forces on a pole due to the wind acting on both the pole and the conductor. For simplicity, only the first of several conductors is shown.

The resisting moment  $M_r$  (N·m) created by the strength of the wood at the base is equal to

$$M_r = \frac{0.0031 f c_g^3}{SF}$$

where

$f$  = ultimate fiber stress of wood poles (see Table 11, p. 100)

$c_g$  = pole circumference at the ground line (m)

$SF$  = safety factor (usually 2 to 2.5)

Finally, for a pole to resist fracture, the resisting moments must equal the sum of all the other moments acting on the pole.

$$M_r = M_p + M_1 + M_2 + \dots (\text{etc., for third and fourth conductor is they are used})$$

$$\frac{0.0031 f c_g^3}{SF} = 0.05 V^2 \left( \frac{d_g + 2 d_t}{3} \right) \frac{h_p^2}{2} + 0.05 V^2 \left( \frac{L_1 + L_2}{2} \right) d_c h_1 + 0.05 V^2 \left( \frac{L_1 + L_2}{2} \right) d_c h_2 + \dots$$

To simplify the calculations, it is assumed below that all the “n” conductors used are located near the top of the pole (i.e.,  $h_p = h_n = h$ ) and have the same diameter. This is usually the case for secondary distribution lines. Any small discrepancies caused by these assumptions err on the side of safety. It is also assumed that forces due to small deviations in the line are not significant. (If they are, they should be countered by guys.)

$$\frac{0.0031 f c_g^3}{SF} = 0.05 V^2 h \left[ \left( \frac{d_g + 2 d_t}{3} \right) \frac{h}{2} + n \left( \frac{L_1 + L_2}{2} \right) d_c \right]$$

Furthermore, for small, short poles, the contribution of the first term in the bracket is considerably smaller than that of the second term and can be disregarded. The maximum span for a pole of given circumference at the ground line is the following:

$$\bar{L} = \left( \frac{L_1 + L_2}{2} \right) = \frac{0.06 f c_g^3}{V^2 h n d_c SF}$$

Note that this is the maximum average span under design maximum wind speeds that the pole can resist. This does not indicate whether or not the conductor strength is adequate. The maximum span that the conductor can support is determined by its strength and allowable sag (see Chapter VII, p.79).

Or equivalently, the pole diameter (m) required to support a given average span is the following:

$$d_g = 0.80 \sqrt[3]{\frac{\bar{L} V^2 h n d_c SF}{f}}$$

## Appendix 6. Some basic electrical concepts and equations

**Voltage drop** along a line affects the quality and usability of the electricity delivered to the consumer. **Power losses** in that line result in an extra cost that must be borne by the consumer. These two parameters are affected by the conductor and line configuration selected. To ensure the most cost-effective service to consumers, it is therefore important to understand the relationships between each of these two parameters and conductor size and configuration.

To calculate the voltage drop and power loss requires knowing the size of the load supplied by the line and its power factor, along with the conductor's resistance and reactance. The conductor's resistance is determined by its type (usually either copper or aluminum) and size (cross-sectional area). The conductor's reactance is determined by its size and its physical proximity to other conductors.

This appendix will first review the basic terms and equations related to voltage drop and power loss. It will then calculate these for a simple single-phase, two-wire system, first for the case where the entire load is located at the end of the line (Fig. 135) and then for the case where the load is distributed along the line. And finally, it will present the equations needed to calculate these two parameters for all commonly used single- and three-phase line configurations, equations that have been summarized in Table 8.

### Resistance and reactance

In the simple single-phase line illustrated in Fig. 136, a generator forces or "pressurizes" the current  $I$  into a conductor and on its way to the load. At the load, the current transfers its power  $P$  to perform some

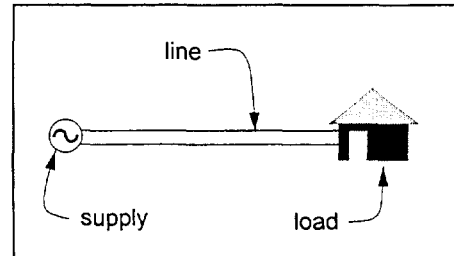


Fig. 135. A basic distribution line.

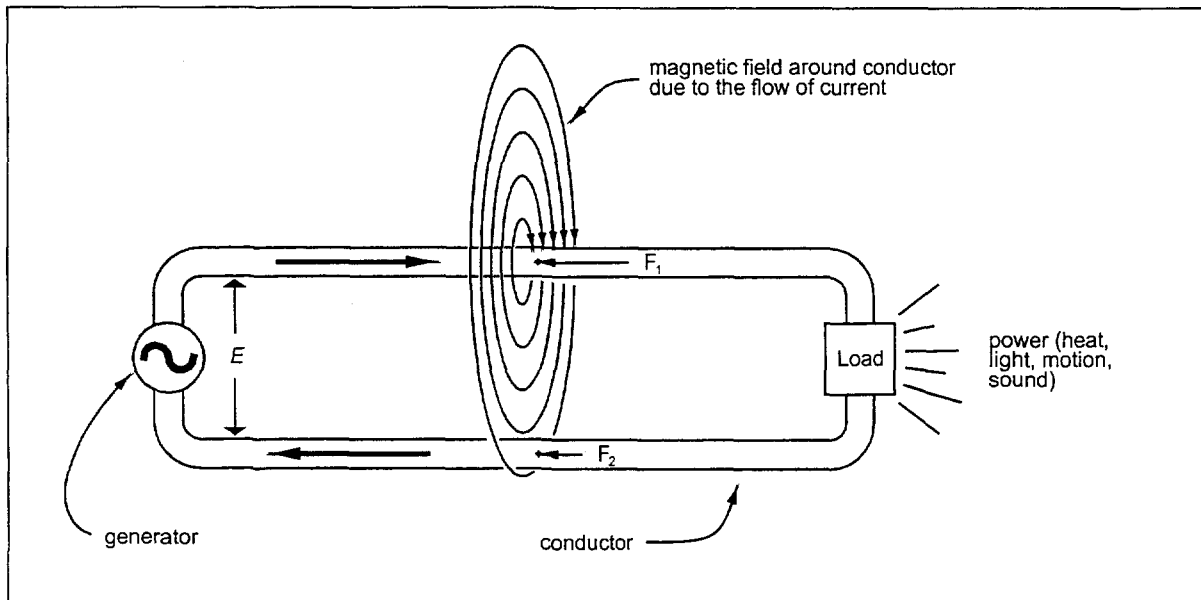


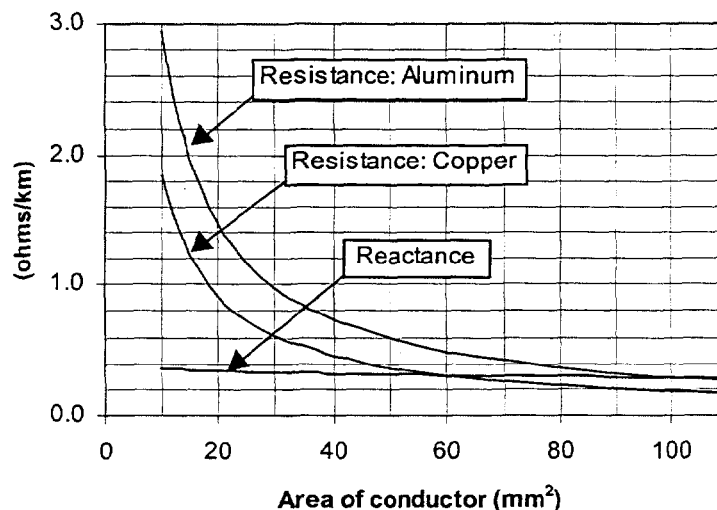
Fig. 136. Impedance originates from the forces on electrons as they pass through a changing magnetic field.

form of work (such as lighting, turning motors, or heating). In the process, it loses its "pressure" or voltage and returns to the generator in the second conductor at which point it is repressurized to repeat this energy transfer process. The voltage  $E$  is a measure of the difference in electric "pressure" between the current in the two conductors.

In the process of transmitting electrical energy from the generator to the load, the current encounters two forces that impede its motion:

- The major force is **resistance** to the current, the flow of electrons within the conductor. The resistance causes the pressure behind the current (i.e., the voltage) to decrease, leaving less "pressure" to push the current through the load and transferring less power to the load. The total resistance of a circuit depends on the material making up the conductor, its length, and its cross-sectional area of the conductor.
- The second force impeding the current or the flow of electrons is called **reactance** and is caused by the magnetic field that grows and collapses around each conductor as the alternating current passes through. As the magnetic field caused by the flow of each electron in the upper conductor in Fig. 136 increases and collapses, it cuts across the flow of other electrons in that conductor, imposing a magnetic force  $F_1$  that opposes their flow, effectively increasing resistance. This magnetic field becomes weaker with distance but also cuts across the flow of electrons in the lower return conductor. This imposes a weaker magnetic force  $F_2$  in the same direction, which in this case happens to be the same direction as the current flow, thereby encouraging that flow or effectively reducing resistance.

In summary, when the two conductors of a single-phase line are far from each other, the magnetic field around each conductor mostly affects the flow within that conductor and somewhat increases the resistance to the current (due to the force  $F_1$  on each electron, opposing its flow). As the conductors are brought closer together, the encouraging effect of the magnetic field from one conductor on the other (giving rise to force  $F_2$ ) pushes the electrons in the other conductor forward, effectively reducing the resistance to flow or reactance. The net effect is that, while reactance always adds additional resistance to the flow of current in a distribution line, this resistance diminishes somewhat as the separation of the conductors is reduced.



### Graphical determination of resistance and reactance

Figure 137 presents the resistance

Fig. 137. Resistance and reactance for aluminum and copper conductor. An equivalent spacing of 0.30 m and a frequency of 55 Hz are assumed.

and **reactance** of conductor commonly used on distribution lines as a function of its cross-sectional area. Note that reactance is a function of the geometry of the conductor and not of the material of which it is constructed.

A conductor's reactance is one factor used in determining its voltage drop in a given situation. But for conductor sizes commonly used as distribution lines within a mini-grid, reactance usually plays a minimal role because, as can be observed from Fig. 137, resistance is usually considerably larger. Therefore, while the precise value of reactance depends on both system frequency and equivalent spacing, any figures more precise than those obtainable from the graph are unnecessary for small conductor because this factor contributes little to voltage drop.

However, if large conductor is necessary, a more precise value for reactance may be necessary and can be obtained as follows:

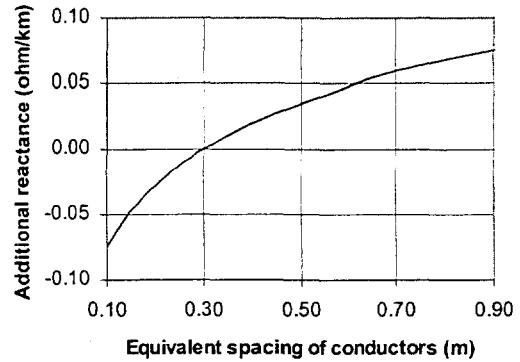
- To determine the reactance for another conductor spacing, the value for the "equivalent spacing" must first be determined. For a single-phase line, the equivalent spacing is simply equal to the physical spacing between the two conductors. The equivalent spacing for a three-phase line is explained later in Eqn. (3). The corresponding reactance that must be added to or subtracted from the reactance found in the graph in Fig. 137 can be determined from Fig. 138.
- To determine the reactance for another frequency, take the value of reactance obtain above and add or subtract 10 % depending on whether the supply frequency is 60 or 50 Hz, respectively.

For example, assume that the reactance of a single-phase line of 80-mm<sup>2</sup> copper or aluminum conductor, a spacing of 0.20 m, and operating at 50 Hz is required. To take into consideration the smaller equivalent spacing, begin with the 0.30 ohms/km associated with this size conductor with a spacing of 0.30 m (from Fig. 137) and add a negative 0.04 (from Fig. 138) associated with the smaller equivalent spacing. This leads to a reactance to 0.26 ohm for each kilometer of conductor. To take into account the reduced frequency of 50 Hz, 10 % of this value or about 0.03 ohms/km is then subtracted from the value just obtained, which leads of a final reactance of 0.23 ohms/km.

The graphs and example illustrate how placing the two conductors closer together than 0.30 m effectively reduces the reactance (as previously explained) by adding a negative number to the value found in Fig. 137 for a spacing less than 0.30 m. Aerial bundled cable, where insulated conductors are closely wrapped around each other, presents less reactance because the size of the magnetic forces from the first conductor encouraging the flow in the second approaches the size of the magnetic forces opposing the flow of current in the first conductor.

#### Calculation of resistance and reactance by equations

The unit **resistance** (ohm/km) of a conductor depends on (1) the material used and (2) its cross-sectional area.



**Fig. 138. This indicates the additional reactance to that listed in Fig. 137 resulting from changes in the equivalent spacing of the conductors.**

The usual materials used are either copper or aluminum. Occasionally, steel conductors are used. Of these, copper has the least resistance. The resistance of aluminum is 1.6 times that of copper and steel is 10 times that of copper.

The equation for the resistance of a conductor is the following:

$$r = \frac{18.4 \cdot k}{A (\text{mm}^2)} \text{ ohm/km} \quad (1)$$

where

- $A$  = cross-sectional area of the conductor ( $\text{mm}^2$ )
- $k$  = 1.0 for copper
- 1.6 for aluminum
- 10. for steel

For ACSR, the cross-sectional area of the conductor is the total cross-sectional area of the aluminum wires making up the ACSR. When calculating resistance, the steel core is assumed not to conduct.

Line **reactance** does not depend on the material used for the conductor. Rather, it depends on geometrical considerations—the size of the conductor and the equivalent spacing between conductors—as well as the frequency of the supply. The equation for the reactance of a conductor is

$$x = 2 \pi f \left[ 19 + 46 \log_{10} \left( \frac{s}{d} \right) \right] 10^{-5} \text{ ohm/km} \quad (2)$$

where

- $f$  = line frequency, usually 50 or 60 Hz
- $s$  = equivalent spacing of conductors in meters (see below)
- $d$  = overall physical diameter of the conductor (meters) =  $\sqrt{\frac{4A}{\pi}} \cdot 10^{-3}$

Note that if stranded conductor or cable is used, the overall physical diameter of the conductor is larger than the diameter associated with the actual cross-sectional area  $A$  of the metal making up the a conductor. The overall physical diameter of the cable also includes voids between the strands making up the conductor.

For a single-phase configuration, the equivalent spacing is equal to the distance between phase conductors. For a three-phase configuration, the equivalent spacing is

$$s = \sqrt[3]{s_1 \cdot s_2 \cdot s_3} \text{ m} \quad (3)$$

where  $s_1$ ,  $s_2$ , and  $s_3$  are the distances (in meters) between the first and second, second and third, and third and first conductors.

#### Example for calculating $r$ and $x$

A single-phase line of AWG #4 ( $21 \text{ mm}^2$ ) copper conductor supplied by a 60 Hz generator is being considered. This seven-strand conductor has an overall diameter of 0.0060 m, the conductor spacing is 0.30 m, and the area of the conductor is  $A = 21 \text{ mm}^2$ . Therefore, from Eqn. (1):

$$r = \frac{(18.4)(1.0)}{21} = 0.88 \text{ ohm/km}$$

and from Eqn. (2):

$$\begin{aligned} x &= 2 \cdot 3.14 \cdot 60 \cdot \left[ 19 + 46 \log_{10} \left( \frac{0.30}{0.0060} \right) \right] 10^{-5} \\ &= 380 (19 + 77) 10^{-5} \\ &= 0.37 \text{ ohm/km} \end{aligned}$$

Note that if the overall physical diameter of the conductor is unknown, it can also be estimated if the number of strands and area of the conductor are known. For example, because the area of the conductor in this case is about 21 mm<sup>2</sup>, each of the seven strands has an area of 3.0 mm<sup>2</sup>. Because  $A = \pi d^2/4$ , each strand must therefore have a diameter of about 2.0 mm or 0.0020 m. As can be seen from Fig. 139 for the case of a cable with 7 strands, the overall diameter of the conductor is equal to three times the diameter of a single strand or about 0.0060 m.

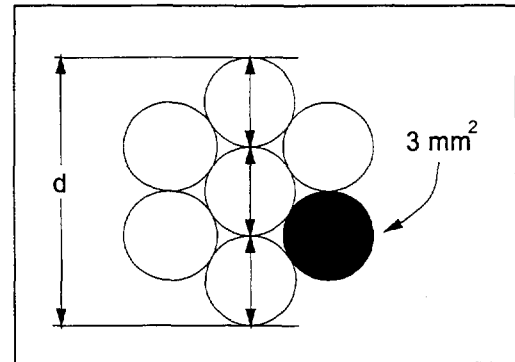


Fig. 139. Cross-sectional view of a seven-strand conductor.

### Power and power factor

In addition to depending on the resistance and reactance of the conductor used, voltage drop and power loss also depend on the magnitude of the current transmitted by the conductor. This latter is determined by the power  $P$  consumed by the load, its power factor ( $\cos \phi$ ), and the operating voltage. (The power factor can be interpreted as a measure of the efficiency with which the current is used by the load. It is a characteristic of the load itself.)

The relationship between these two parameters and both the current  $I$  through the load and the voltage  $E$  across the load is given by the following:

$$P(\text{kW}) = \cos \phi \times P(\text{kVA}) = \cos \phi \times E(\text{V}) \times I(\text{A}) \times 10^{-3} \quad (4)$$

For example, if 230 V is placed across a fluorescent lamp with a nameplate rating of 0.17 A and a power factor of 0.6, then the power it consumes is

$$P(\text{kW}) = \cos \phi \times E(\text{V}) \times I(\text{A}) \times 10^{-3} = 0.6 \times 230 \text{ V} \times 0.17 \text{ A} \times 10^{-3} = 0.023 \text{ kW} = 23 \text{ W}$$

Or if the same voltage is placed across a resistive load (i.e., with a power factor = 1.0), such as a light bulb, which consumes the same power, the current required by the bulb will be

$$I(\text{A}) = \frac{P(\text{kW}) \times 10^3}{\cos \phi \times E(\text{V})} = \frac{0.023 \text{ kW} \times 10^3}{1.0 \times 230 \text{ V}} = 0.10 \text{ A}$$

### Voltage drop/power loss along a line

This section presents equations for voltage drop and power loss along a distribution line. For the sake of simplicity, these equations are initially derived for the case of a **single-phase, two-wire line**. It first calculates the voltage drop and power loss for a single load located at the end of the line and then for the case where the load is evenly distributed along a line. This section concludes with slightly modified versions of these equations which can be applied to the balanced split-phase and three-phase configurations. The results are summarized in Table 8, p. 75).

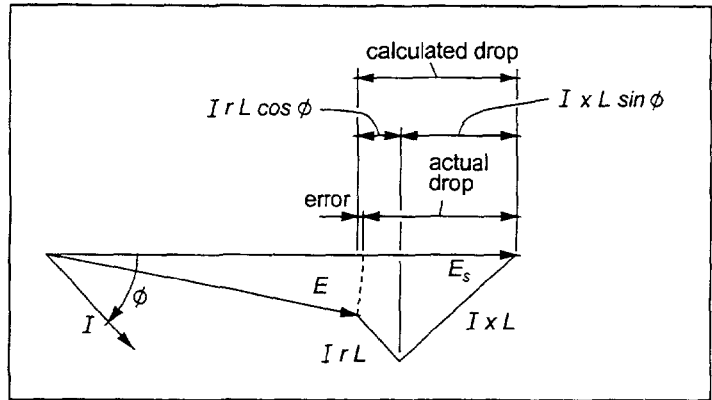


Fig. 140. Vector relationship between voltage, voltage drops, and current in a single line. ( $E_s$  = supply voltage,  $E$  = voltage across load)

For a general case, it is assumed that, because of the nature of the load, the current in a section of line is out of phase with the supply voltage by an angle of  $\phi$  (Fig. 140). While no simple form of an equation for the precise value of the actual voltage drop ( $VD_1$ , volts) along this single line is possible, it can be estimated as the value of the "calculated drop" in Fig. 140:

$$VD_1 \approx I (r \cos \phi + x \sin \phi) L \quad (5)$$

where

- $I$  = current in the line (amperes)
- $r$  = line resistance (ohms/km)
- $x$  = line reactance (ohms/km)
- $L$  = length of the line (km)
- $\cos \phi$  = power factor at the beginning of the line  $\approx$  power factor at the load

The percent voltage drop at the load is

$$\%VD \approx 100 \frac{VD}{E_s} \approx 100 \frac{VD}{E} \quad (6)$$

because, for the typical situation where the voltage drop must be low,  $E_s \approx E$ .\*

The power loss is more straightforward to calculate. The loss along a single line is simply

$$P_l(\text{kW}) = I^2 r L \cdot 10^{-3} \quad (7)$$

\* The factor of 100 is included to convert the ratio to a percent. Note that if a computerized spreadsheet program is used, it can be set to automatically display the voltage drop ratio as a percent; in this case, no additional factor of 100 is required.



### Single-phase, two-wire configuration

#### Calculations for load concentrated at end of line

Once the supply voltage  $E$  (in volts), conductor resistance  $r$  and reactance  $x$  (both in ohms/km), line length  $L$  (in kilometers), and power consumption  $P$  and power factor  $\cos \phi$  of a single load located at the end of a single-line have been determined, the line current can be calculated from Eqn. (4) as follows:

$$I = \frac{P(\text{kVA})}{E} \cdot 10^3 = \frac{P(\text{kW})}{E \cos \phi} \cdot 10^3 \quad (8)$$

Substituting this into Eqn. (5), the voltage drop  $VD$  along two lengths of line (i.e., to the load and back) becomes

$$VD \approx 2L(r \cos \phi + x \sin \phi)I = 2L(r \cos \phi + x \sin \phi) \times \frac{P(\text{kW})}{E \cos \phi} \cdot 10^3 \text{ volts} \quad (9)$$

The percent voltage drop becomes

$$\%VD \approx 200L(r \cos \phi + x \sin \phi) \frac{I}{E} = 2L(r \cos \phi + x \sin \phi) \times \frac{P(\text{W})}{E^2 \cos \phi} \cdot 10^5 \% \quad (10)$$

The power loss along the two length of line becomes

$$P_l(\text{kW}) = 2LrI^2 \cdot 10^{-3} = 2Lr \left( \frac{P(\text{kW})}{E \cos \phi} \right)^2 \cdot 10^3 \quad (11)$$

For example, if a 21 mm<sup>2</sup> single-phase, 240-V ACSR line with a spacing of 0.50 m is used to bring power 500 m from the power house to a load of 3 kW with a power factor of 0.95, what is the percent voltage drop and power loss along that line?

$$\cos \phi = 0.95$$

$$\phi = 18^\circ$$

$$\sin \phi = 0.31$$

$$r = 1.39 \text{ ohm/km}$$

$$x = 0.44 + 0.05 = 0.49 \text{ ohm/km}$$

$$I = \frac{3,000 \text{ W}}{(230 \text{ V})(0.95)} = 13.7 \text{ A}$$

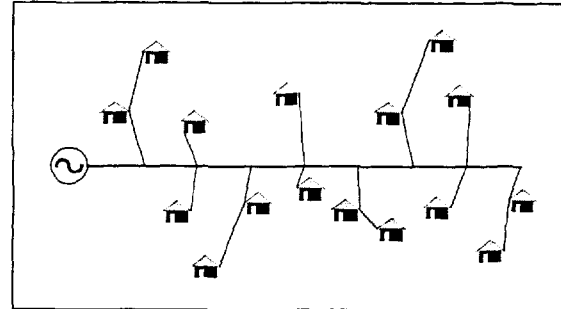
$$VD = (2)(0.50 \text{ km})[(1.39)(0.95) + (0.49)(0.31)] \text{ ohm/km} (13.7 \text{ A}) = 20 \text{ V}$$

$$P_l = (2)(0.50 \text{ km})(1.39 \text{ ohm/km})(13.7 \text{ A})^2 = 260 \text{ W}$$

Therefore, when supplying 3 kW of power to the load, the voltage drop along the line is  $20/230 = 9\%$  and 260 W of power is lost in resistive heating of the line.

**Calculations for loads uniformly distributed along line**

If rather than the load being located at the end of the line, the **load is uniformly distributed along the line** as illustrated in Fig. 141, the expressions for voltage drop at the end of the line is a simple variant of the above expressions. In this case,  $P(W)$  in the following equations will represent the sum of all the loads along the line. With a uniform load along the line, the voltage drop is precisely half the voltage drop that would result had the same load been located entirely at the end of the line. Applying this factor of one-half to Eqn. (10), the percent voltage drop of a load  $P$  uniformly distributed along a single-phase line of length  $L$  becomes



**Fig. 141. A diagram of consumers uniformly distributed long a line.**

$$\%VD = 100 (r \cos \phi + x \sin \phi) \frac{I L}{E} = (r \cos \phi + x \sin \phi) \frac{P(\text{kW}) L(\text{km})}{E^2 \cos \phi} \cdot 10^5 \% \quad (12)$$

The power loss is precisely one-third of the power loss that would result with the load located entirely at the end of the line. Applying this factor of one-third to Eqn. (11), the equation for power loss becomes

$$P_l(\text{kW}) = \frac{2 L r I^2}{3} \cdot 10^{-3} = \frac{2 L r}{3} \left( \frac{P(\text{kW})}{E \cos \phi} \right)^2 \cdot 10^3 \quad (13)$$

**Calculations for loads at various points along line**

With the typical mini-grid, consumers are scattered at various points along the distribution line rather than being uniformly distributed along it as in the previous case. In this case, it is still possible to easily and accurately calculate the voltage drop, provided that the power factors for all consumer are approximately equal. In this case, the product of power demand and distance from the supply for each consumer must first be calculated, and then these products for all "N" consumers involved must be summed. This is represented by the numerator in Eqn. (14). The voltage drop at the end of the single-phase, two-wire line will then be the same as if a load  $P_T(\text{kW})$ —equal to this total sum divided by the distance from the supply to the end of the line—is placed at the end of that line. This equivalent load is the following:

$$P_T(\text{kW}) = \frac{\sum_{n=1}^N L_n(\text{km}) \times P_n(\text{kW})}{L(\text{km})} \quad (14)$$

and the percent voltage drop at the end of the single-phase, two-wire line is obtained by substituting this into Eqn. (10) results in the following equation for:

$$\%VD \approx 2(r \cos \phi + x \sin \phi) \frac{\sum_{n=1}^N L_n (\text{km}) \times P_n (\text{kW})}{E^2 \cos \phi} \cdot 10^5 \% \quad (15)$$

An example of the application of these equations is found in Chapter VII (p. 71).

### General solution

Since the power consumed by any load is equal to the product of the voltage across that load, the current through the load, and its power factor, the current for each of the basic line configurations is as shown in Fig. 142. It is obtained by solving the first equation for each configuration for the current,  $I$ . The percent voltage drop affecting each load is also indicated in Fig. 142 as a function of the voltage drop along a single length of line,  $VD_l$ . The value of the latter is found in Eqn. (5). Note that the actual voltage drop experienced by the load in the single-phase, two-wire configuration is twice the value of  $VD_l$  because the voltage drop occurs along two lengths of line. For a split-phase configuration, the voltage drop occurs only in one conductor, as the currents cancel out in the return conductor if the loads are balanced. The voltage drop experienced by the load on each phase of the three-phase, delta configuration is  $\sqrt{3}$  times the value of  $VD$  because the voltage drop occurs along two lengths of line but these drops are out of phase. And the voltage drop experienced by each load in the wye configuration occurs in only one conductor, for the same reason as for the split-phase configuration. Substituting the values of all the variables will lead to the equations for percent voltage drop found in Table 8.

The total loss of power along the circuit is obtained by substituting the value for current for the configuration under consideration (Fig. 142) and multiplying the resultant by the number of phase conductors carrying the current (2 for either single-phase configuration or 3 for either three-phase configuration). This leads to the power loss equations found in Table 8. Note that for a balanced circuit, which is assumed here, the current in the neutral is zero and therefore contributes nothing to the total loss.

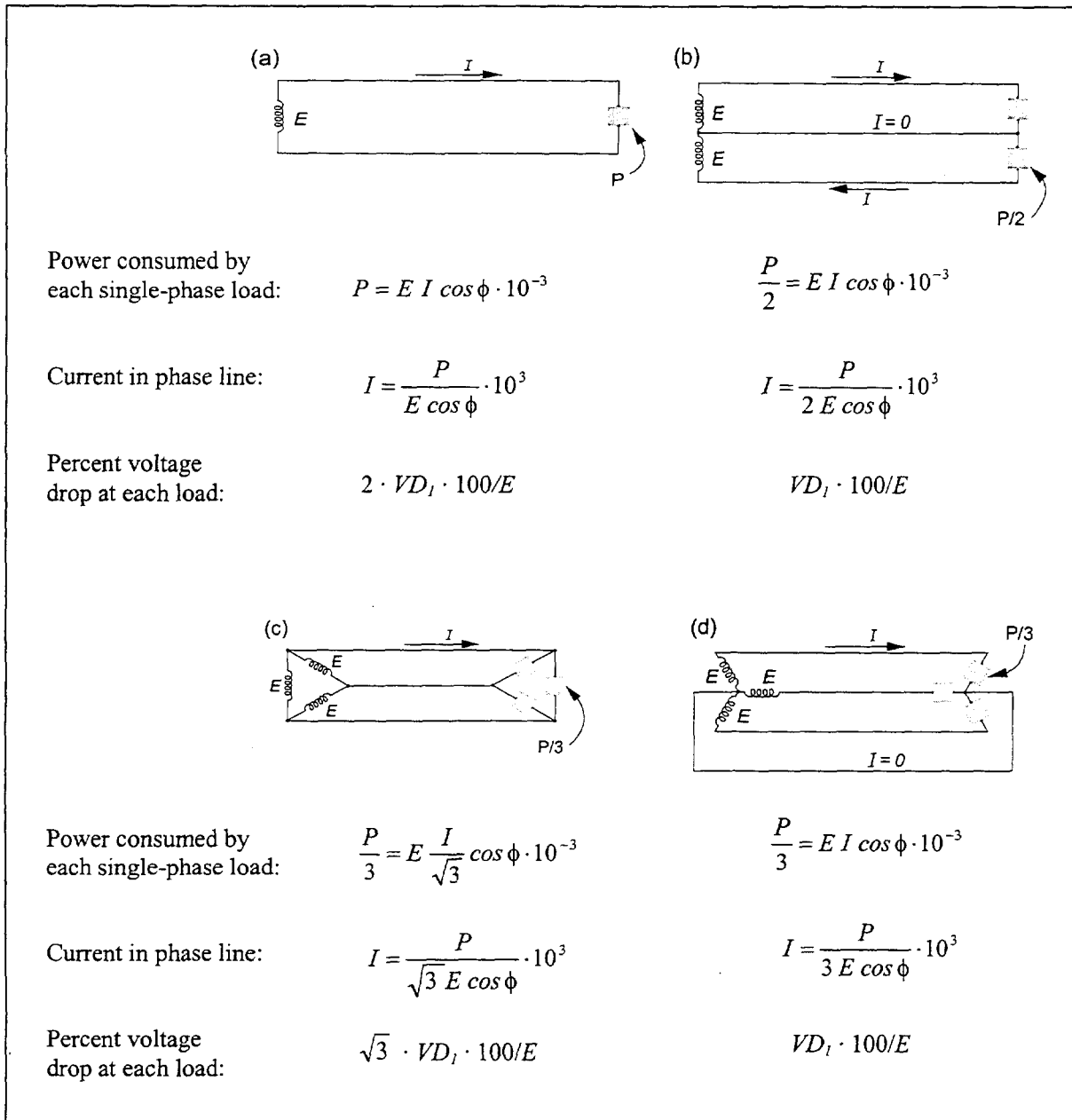


Fig. 142. Line current for different configurations, each serving a total load of  $P$  (kW). Balanced loads are assumed in all cases. The value of  $VD_1$  is found in Eqn. (5).

## Appendix 7: Computational examples

By means of examples, this appendix illustrates how conductor size is determined in several situations. At the same time, these examples will also illustrate (1) the impact of power factor on the size and cost of the conductor, (2) the impact of system configuration and conductor options on the cost of line construction, and (3) the relative accuracy of several approaches to estimating conductor size, respectively.

### (1) Impact of power factor on system cost

In the first phase of electrification, lighting is the most popular end-use. And while incandescent bulbs are still popular in many parts of the world because of their low cost, many are now aware that fluorescent lighting is more efficient, that is, that it produces considerably more lighting than can be achieved with incandescent lamps for the same amount of power consumed. But even with the use of fluorescent lighting, not all are aware that fluorescent units commonly available in many countries are not power-factor corrected; neither are they aware of the implication this has on system cost. While lack of power-factor correction does not directly affect the amount of light available, this does have two implications which lead to increased cost:

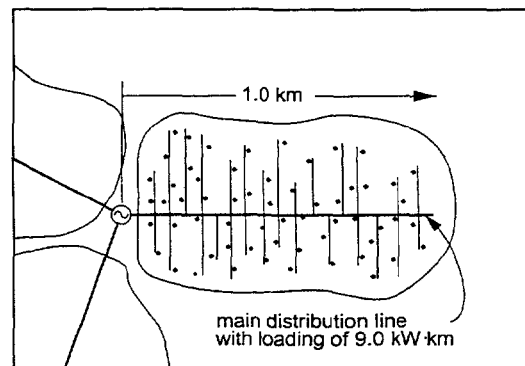
- The conductor needed to serve the load may be larger than would otherwise be necessary.
- Increased generation capacity will also be required (even though the same power is consumed).

For this example, assume that a three-phase generator supplying 230 V at 50 Hz is located in the middle of the village and that a single-phase, 1.0 km-long, single-phase, two-wire aluminum line serves similar lighting needs of each of three sectors in the village (Fig. 143). Assume that each sector has a load of 60 homes with the equivalent of 40 watts of fluorescent lighting in each, that this load is evenly distributed along the line, and that the voltage drop should not to exceed 6 % at the end of the line.

In each home, this same amount of lighting can be met by either of the following:

- Two 75 W bulbs
- Two 20-W fluorescent lamps without power-factor correction (with a power factor of 0.6), with each consumer requiring 45 W (which includes 5 W to account for losses in the ballast)
- Two 20-W fluorescent lamps with the power-factor corrected to 1.0, also requiring 45 W.

For each of these cases, the conductor size that will be required to ensure that the percent voltage drop does not exceed 6 % and the generator capacity required to serve this load will be derived below.



**Fig 143. One of three portions of a village for which conductor and generator size are to be calculated.**

## **Incandescent lighting**

### ***Conductor requirements***

In this case, each main ACSR distribution line will need to be sized to serve a total load of 60 x 150W or 9.0 kW uniformly distributed along the line. Using the appropriate graph in Box 5, with  $k = 4.5 \text{ kW}\cdot\text{km}$ , an aluminum conductor of  $80 \text{ mm}^2$  would be required to keep the voltage drop to within about 6 %.

### ***Generator requirements***

Each phase of the three-phase generator must serve a 9 kW resistive load. A total generating capacity of 27 kW (at a power factor of 1.0) or 27 kVA would be required.

## **Fluorescent lighting without power-factor correction**

### ***Conductor requirements***

In this case, each distribution line will need to be sized to serve a total load of 60 x 45 W or 2.7 kW uniformly distributed along the line. Using the appropriate graph in Box 5, with  $k = 1.4 \text{ kW}\cdot\text{km}$  and a power factor of 0.6, an aluminum conductor of  $40 \text{ mm}^2$  would be required to keep the voltage drop to within 6 %.

### ***Generator requirements***

Each phase of the three-phase generator must serve a 2.7 kW load with a power factor of 0.6. A total generating capacity of  $P(\text{kVA}) = P(\text{kW})/\cos \phi = 8.1/0.6$  or 14 kVA will be required. Fluorescent lighting makes more efficient use of the current generated and, therefore, less current and reduced generating capacity are required.

## **Fluorescent lighting with power-factor correction**

### ***Conductor requirements***

In this case, each line will again need to be sized to serve a total load of 60 x 45 W or 2.7 kW uniformly distributed along the line. Using the appropriate graph in Box 5, with  $k = 1.4 \text{ kW}\cdot\text{km}$  and a power factor which has been corrected to 1.0, an aluminum conductor of  $25 \text{ mm}^2$  would be required to keep the voltage drop to within 6 %.

### ***Generator requirements***

Each phase of the three-phase generator must again serve a load of 2.7 kW but with a power factor of 1.0. A total generating capacity of  $P(\text{kVA}) = P(\text{kW})/\cos \phi = 8.1/1.0$  or about 8.0 kVA will now be required. This further decrease in the capacity of the generator is due to the fact that, by adding power-factor correction, still more efficient use is being made of the current and, therefore, even less current is required of the generator. Therefore, the wire in the generator windings can be reduced in size, resulting in a less expensive generator.

## **Conclusions**

The conclusions of the previous calculations are summarized in Table 27. As can be seen, replacing incandescent lighting with fluorescent lighting results in cost savings in both conductor and generator capacity but the full extent of the savings is not evident until power-factor correction is incorporated in the fluorescent lighting units. In using fluorescent lighting with power-factor correction, conductor required is only about one-third the size (and cost) of the conductor that would have been used to supply incandescent lighting.

A word of caution should be noted here. For larger loads as were assumed above, larger conductor is required and power factor is an important factor in selecting the appropriate conductor size based on acceptable voltage drop, as is illustrated in Table 27. However, if smaller loads and distances are involved in a given situation, then smaller conductor would be required. In this case, the power factor does not play as important a role in determining the voltage drop.

**Table 27. Conductor size and generator capacity required for the same amount of lighting.**

Description of lighting	Required size of conductor	Required generator capacity
Incandescent	80 mm <sup>2</sup>	27 kVA
Fluorescent, without power-factor correction	40 mm <sup>2</sup>	14 kVA
Fluorescent, with power-factor corrections	25 mm <sup>2</sup>	8 kVA

This can be seen by changing the form of the equation for  $Y$  in Table 8, which is used to calculate the voltage drop along a conductor, as follows:

$$Y = 2 \left( r \cos \phi + x \sin \phi \right) \frac{P L}{E^2 \cos \phi} \cdot 10^{-5} = 2 \left( \underline{\underline{r + x \frac{\sin \phi}{\cos \phi}}} \right) \frac{P L}{E^2} \cdot 10^{-5}$$

For smaller conductor, Fig. 137 in Appendix 6 illustrates that reactance  $x$  becomes much less important than the resistance  $r$  of the conductor. Since even for low power factors, the value of  $(\sin \phi / \cos \phi)$  is not much greater than 1, the double-underlined term in the equation above becomes less important in affecting the voltage drop than the value of  $r$ . Therefore, for small conductor, the conductor size that is necessary to keep to within an acceptable voltage drop is much less affected by the power factor than is large conductor.

For example, assume that the fluorescent lighting load evenly distributed along each line were reduced somewhat to perhaps 1.0 kW·km rather than the 2.7 kW·km assumed above. The minimum conductor size for a line serving uncorrected fluorescent lighting would then be 11 mm<sup>2</sup> while that required to serve corrected fluorescent lighting would be 10 mm<sup>2</sup>. Given that conductor is only available in a few discrete sizes and that the same size conductor would be used in both cases, having properly corrected fluorescent lighting would essentially have no impact on conductor size when loads are small.

In this example, the generator required to serve the uncorrected fluorescent lighting load in the village would still, in theory, be considerably larger than that needed to serve the corrected lighting load (4.8 kVA vs. 3.0 kVA). However, in this case, because the size options for small gensets are limited, a 5 kVA would probably be required in both cases and power factor correction would also have no impact on generator cost. Note that operating costs would be marginally higher with no power-factor correction because of increased power losses in the distribution line due to the higher currents associated with a low power factor.

## **(2) Impact of configuration on distribution system cost**

Consumers in countries where the distribution voltage on a single-phase, two-wire line is 120 V rather than 230 V are somewhat handicapped because this lower voltage implies greater currents to supply the same loads, and these in turn imply a greater voltage drop and line (energy) losses. Alternatively, to keep to within the same voltage drop, the area (and cost) of the conductor must increase by a factor of about four to serve the same load at this lower voltage.

However, by reverting to a different configuration, it may be possible to reduce costs. The following example first calculates the installed line cost for supplying a specific load with a single-phase, two-wire configuration. It then illustrates the impact on cost of using a single-phase, three-wire configuration to serve the same load and then of using a three-phase, four-wire configuration.

For this example, it is assumed that a single-phase generator is available in the village and that, by proper connections to the generator terminals, either 120 V, 120-0-120 V, or 208/120 V at 60 Hz can be generated. The generator is at the end of a 1.4 km ACSR distribution line which serves 40 consumers evenly distributed along that line. Each consumer has a 20-W fluorescent lamp, with the power factor corrected to 1.0, that consumes a total of 25 W.

To determine the approximate conductor size that will be required so that the voltage drop does not exceed the desired maximum set at 6 %, the graphs in Box 5 (p. 77) will again be used. However, since the nominal voltage used by the consumer is other than 230 V, the value of  $k$  described in that box must be modified as explained therein. Alternatively, the equations in Table 8 can be used.

Note that Box 5 assumes an operating frequency of 50 Hz while, in this case, the frequency is 60 Hz. In theory, the graphs in Box 5 have not been prepared for this frequency and one should rely on the formulas in Table 8 since the reactance of the conductor depends on the frequency of the supply (see Eqn. (2) in Appendix 6). However, because in this case the power factor,  $\cos \phi$ , is 1.0, then  $\sin \phi = 0$  and it can be seen from the equations in Table 8 that the value of  $Y$  (and therefore the percent voltage drop) does not depend of the reactance of the conductor. For the same reason, equivalent spacing of the conductor, which also affects reactance, has no impact in this case. Therefore, the graphs in Box 5 can be used. For non-unity power factors, the original equations in Table 8 would have to be used if more accurate results are required.

### Two-wire configuration

For this example, a total load of 1.0 kW (with  $\cos \phi = 1.0$ ) uniformly distributed over a line 1.4 km long is to be supplied. As explained in Box 5, the value of  $k$ , modified for a voltage of 120 V, is as follows:

$$k = \frac{(1.0 \text{ kW})(1.4 \text{ km})}{2} \left( \frac{230}{120} \right)^2 = 2.6 \text{ kW} \cdot \text{km}$$

From the first graph, the distribution line would require two lengths of 48 mm<sup>2</sup> aluminum conductor or AWG 1/0 to handle the expected current without exceeding a 6 % voltage drop.

### Three-wire configuration

As explained in Box 5, for this case, the value of  $k$  for a perfectly balanced system, modified for a voltage of 120 V, is as follows:

$$k = \frac{(1.0 \text{ kW})(1.4 \text{ km})}{2} \left( \frac{1}{4} \right) \left( \frac{230}{120} \right)^2 = 0.65 \text{ kW} \cdot \text{km}$$

In this case, an aluminum conductor of about 12 mm<sup>2</sup> or AWG #6 would be necessary. Therefore, although this distribution line would now require three lengths of conductor, a considerably smaller conductor would be required. Note that this value is only correct if the loads along the line are perfectly balanced. In reality, this is difficult to ensure. If we assume a 50 % load unbalance, the above value of  $k$  must be multiplied by a factor of 1.8 as indicated in the last column in Table 8. For the new value of  $k = 1.2$ , the distribution line would require a 23 mm<sup>2</sup>, which is close to a larger, AWG #4 conductor.



### Three-phase, four wire configuration

Assuming the realistic case where the circuit has a 50 % load unbalanced, Box 5 indicates that the value of k is as follows:

$$k = \frac{(1.0 \text{ kW})(1.4 \text{ km})}{2} \left(\frac{1}{4}\right) \left(\frac{230}{120}\right)^2 = 0.65 \text{ kW} \cdot \text{km}$$

In this case, AWG #6 would be necessary. Compared to the unbalanced single-phase, three-wire configuration above, this configuration requires four length of smaller conductor.

### Costs

A comparative costing of these four configurations will be calculated using costs from El Salvador. To illustrate the impact of conductor type on cost, two conductor options will also be considered. The first is the use of uninsulated ACSR conductor and the second is the use of multiplex as explained in Box 4. The costs assumed for this costing are indicated in Table 28.

**Table 28. Recent small-quantity costs for quality materials and labor in El Salvador, including duties, taxes, warehousing, and delivery. Costs are in U.S. dollars and totals are expressed to two significant figures.**

Conductor	Conductor cost/m			Poletop hardware cost/pole		
	Materials	Labor	Total	Materials	Labor	Total
#1/0 ACSR (2-wire)	1.84	.56	2.40	22.84	20.64	43
#4 ACSR (3-wire)	1.05	.72	1.80	31.26	30.96	62
#6 ACSR (3-wire)	.90	.33	1.20	31.26	30.96	62
#6 ACSR (4-wire)	1.20	.44	1.60	41.68	41.28	83
#1/0 duplex	2.24	.30	2.50	10.60	10.32	21
#4 triplex	2.30	.15	2.40	10.20	9.50	20
#6 triplex	1.21	.12	1.30	9.80	9.30	19
#6 quadruplex	1.70	.12	1.80	9.80	9.30	19

Table 29 summarizes the component costs for a single 30-m span (conductor plus poletop hardware at the pole at the end of that span) for the four configurations being considered in the example.

### Conclusions

Several conclusions can be drawn from Table 29:

- Labor costs can be a significant portion of line construction cost, especially for bare ACSR lines which are much more labor intensive than multiplex lines (bare ACSR requires that each line to be strung separately whereas one conductor is strung if bundled cable is used). The costs in Table 28 are for electric-utility-implemented installations. In cases where labor costs of lower or

**Table 29. Breakdown of the costing per 30-m span for all the options being considered for supplying the village load. For two cases indicated, a 50 % load unbalance is assumed.**

Configuration	Bare ACSR			Multiplex		
	Materials	Labor	Total	Materials	Labor	Total
Two-wire (#1/0)	\$78	\$37	\$115	\$78	\$19	\$97
Three-wire (#4) (unbalanced)	\$62	\$53	\$115	\$79	\$14	\$93
Three-wire (#6) (balanced)	\$58	\$41	\$99	\$46	\$13	\$59
Four-wire (#6) (unbalanced)	\$78	\$54	\$132	\$61	\$13	\$74

where a more rudimentary village design which require less labor are utilized, labor cost can be reduced significantly.

- Independent of the configuration, the multiplex (or ABC) option can be considerably cheaper, primarily because of the fact that less labor is required for its installation.
- The single-phase, three-wire configuration is the least costly if balanced loads are considered. However, as noted, this is difficult to ensure. With a more realistic unbalance of 50 %, the least-cost configuration depends on the conductor option. The three-phase, four-wire configuration is the least costly (at \$74 per span) when multiplex conductor is used while either of the single-phase configurations is the least costly (at \$115 per span) when bare ACSR is used.
- Three-phase distribution is, in theory, more efficient than single-phase distribution. However, this example illustrates that, in this case, the cost for a three-phase line is greater than even a single-phase, two-wire line.

### **(3) Sizing a distribution line for motor starting**

It is assumed that a 15 kW diesel genset is located on one side of a village and that one load being supplied is a 2 hp motor to run a rice huller that must be located 1400 m away. To facilitate motor starting and minimize conductor size, a 220/380 V, three-phase, four-wire line will be used to supply the motor. The motor efficiency is 80 %, its power factor is 85 % during normal operation and 60 % during start-up, and the current draw is 6 times the normal operating current during start-up. Is the generator of adequate capacity to start the motor? And if it is, is a 10 mm<sup>2</sup> copper conductor of adequate size to ensure that the voltage drop along the line to the motor during its start-up does not exceed about 20 %?

The maximum horsepower capacity of a three-phase motor driven by a three-phase synchronous generator is about 15 % of the generator's kilowatt rating. This generator should be able to start a motor with a capacity of up to about 2.2 hp and should therefore be adequate to start the proposed motor.

To determine whether the proposed conductor is of adequate size, the voltage drop must be calculated. But this requires that the current needed by the motor first be calculated. From the equation on p. 39), the power input to the motor necessary to drive the rice huller during normal operation is as follows:

$$P_i = \frac{(2.0 \text{ hp}) \left( 750 \frac{\text{W}}{\text{hp}} \right)}{(0.80)(0.85)} = 2.2 \text{ kVA}$$

and then, from Fig. 142d, the line current during this time would be

$$I = \frac{2200 \text{ VA}}{3(220 \text{ V})} = 3.3 \text{ A}$$

The start-up current will attain six times this value or 20 A at the power factor of 0.60 noted earlier.

To determine the percent voltage drop under these conditions, the values of resistance and reactance of the conductor must first be found. From Fig. 137, for a 10 mm<sup>2</sup> copper conductor, this can be found to be  $r = 1.8$  ohms/km and  $x = 0.4$  ohms/km. Inserting these values into the equation for voltage drop in Fig. 142d and Eqn. (5) referred to in that figure, the percent voltage drop is the following:

$$\begin{aligned} \%VD &= VD_l \frac{100}{E} = I (r \cos \phi + x \sin \phi) \frac{100}{E} \\ &= 20 [(1.8)(1.4)(0.6) + (0.4)(1.4)(0.8)] \frac{100}{220} = 18 \end{aligned}$$

The resulting voltage drop of 18 % during motor start-up falls within the acceptable range. Note that this assumes that the only load on the distribution line is the motor. If the possibility exists that lighting or other loads may be connected to that line during motor start-up, either before or after the location of the motor along the distribution line, these currents must also be included in the above calculations because they also would contribute to the voltage drop along the line.

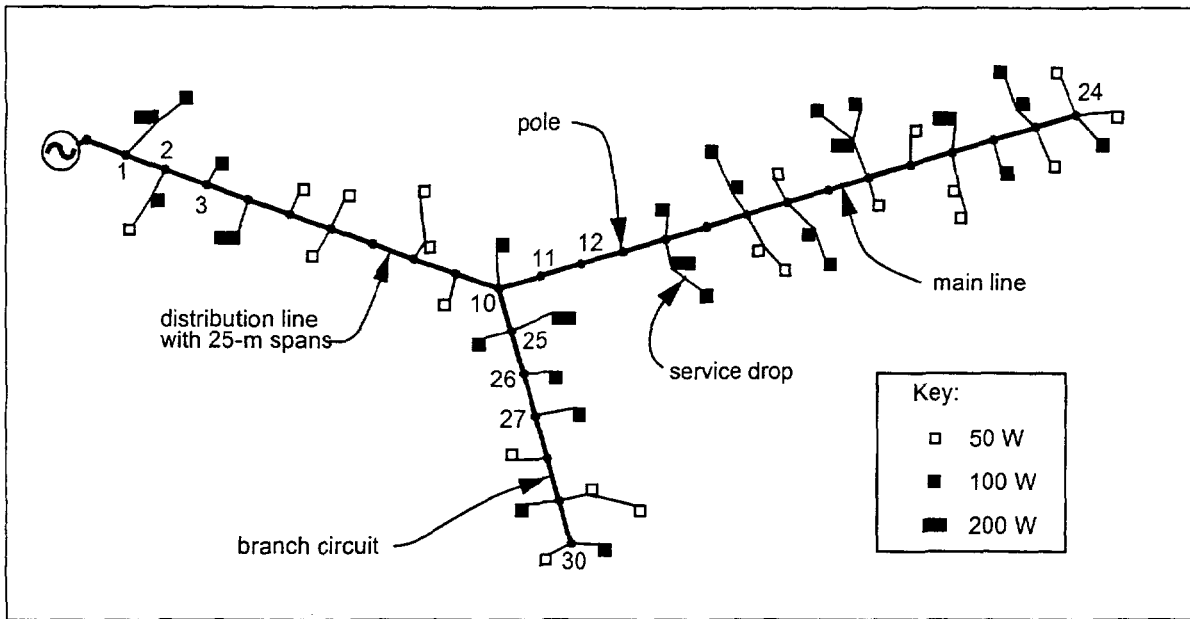
After start-up, when the power factor increases to 0.85 and the current demand reduces to 3.3 A, the percent voltage drop due to the normal operation of the motor will reduce to the following expression:

$$\begin{aligned} \%VD &= VD_l \frac{100}{E} = I (r \cos \phi + x \sin \phi) \frac{100}{E} \\ &= 3.3 [(1.8)(1.4)(.85) + (0.4)(1.4)(0.50)] \frac{100}{220} = 3.6 \end{aligned}$$

A 3.6 % voltage drop is acceptable at the motor location. However, as noted above, other loads along the distribution line will increase voltage drop along that line and calculations for the voltage drop at the motor location (or at the end of the line) must also consider and include other loads that may be on at the same time.

#### **(4) Impact of approach to conductor sizing on accuracy**

The conductor size for a single-phase line serving a total load of 4.4 kW distributed as shown in Fig. 144 is to be determined. Assume an average power factor of 0.9, a supply voltage of 230 V, and a maximum acceptable voltage drop of about 6 %. It is assumed that ACSR conductor is available in the following sizes: 10, 25, 35, 50, 70, and 100 mm<sup>2</sup>. The graphs in Box 5 will be used for the initial sizing of the conductor. Longer computational methods will then be used to illustrate that these more time-consuming approaches may yield more precise results but that quick estimates are often more than sufficient for the purpose of selecting conductor size.



**Fig. 144.** A map showing the location of consumer loads along the distribution line to be sized, together with their maximum coincident demand.

To reduce project cost, the same size conductor is typically used for the entire network. The use of a single size usually permits a lower unit cost through quantity purchases and minimizes the range of sizes, and costs, for items such as connectors, preformed deadends, and tooling dies (for crimping connectors) required for line installation. For the initial costing, it is assumed that a single-size conductor is used. If it is felt that conductor of this size is too large for use in branch circuits, it is always possible to determine the size of these circuits separately and then to cost them to decide if branch circuits of smaller size are more cost-effective.

Since the maximum voltage drop occurs at the end of the line with the largest combination of loading and length, the line stretching from the supply all the way to the right in Fig. 144 will be the main line that is to be sized. For this sizing, the peak coincident load of 0.90 kW served by the branch circuit heading downward will simply be considered as an additional load to the 50 W consumer load which is also connected to the pole (no. 10) where the lines join.

The easiest cases to analyze are those where the entire load is either concentrated at the end of the line or uniformly distributed along the line. While either of these cases rarely reflects reality, the results obtained still give a rough estimate of conductor size.

- If the entire load were concentrated at the end of the line, this would result in the maximum voltage drop. While this is not the case here, it does set the upper limit on the size of the conductor. In this case,  $k$  (as defined in Box 5) would equal  $(4.4)(.60)$  or  $2.6 \text{ kW}\cdot\text{km}$ . From the first two graphs in Box 5, a  $50 \text{ mm}^2$  aluminum conductor would be required if the power factor were 1.0 and  $75 \text{ mm}^2$  if it were 0.8. For a power factor of 0.9, an estimate for the conductor which would be required would be  $60 \text{ mm}^2$ . Given available sizes noted previously, a  $70 \text{ mm}^2$  aluminum conductor would be required.

- If we assume that the load is uniformly distributed along the line, which is closer to the actual case,  $k$  would equal 1.3 kW·km. For a power factor of 0.9, the actual conductor size would be between 24 mm<sup>2</sup> and 30 mm<sup>2</sup> and a 35 mm<sup>2</sup> conductor would seem to be necessary in this case.

A more accurate estimate is obtained by calculating the sum of the products of power demand at each pole and its distance from the source. This has been done in Table 30. The value of  $k$  is 1.43 kW·km and the conductor size would be 27 mm<sup>2</sup> and 33 mm<sup>2</sup>, implying that a 35 mm<sup>2</sup> conductor would probably be required.

If one required more precise figures, the equations presented on p. 72 can be used. Substituting the appropriate values into those equations yields the required conductor size as  $A = 31$  mm<sup>2</sup>, once more confirming that a 35 mm<sup>2</sup> conductor should be used.

Note that while the results of this last approach may be more accurate, the easier methods described above can lead to results which are as accurate as necessary under the circumstances. Furthermore, it is useless attempting to obtain high accuracy in the calculation when the data used is not accurate. For example, to what accuracy is the power factor known? While it is probably difficult to determine whether the power factor in a situation will be 0.76 or 0.84, using one rather than the other in the equations for voltage drop and power loss can lead to a 10 % difference in these parameters or more depending on actual circumstances. Equivalently, it may mean that the required conductor size may be off by 10 %, or more.

A basic spreadsheet that can also be used for assessing voltage drop and power loss and, thereby, for sizing conductor is described on p. 72. For this specific case where three segments are involved—two end segments and one source segment—three spreadsheet modules are used and the final results are shown in Fig. 145. ***Only those fully knowledgeable with manipulations of formula and data within computerized spreadsheets should attempt their use; otherwise, numerous errors could be introduced.***

In this case, a 35 mm<sup>2</sup> conductor was assumed and the spreadsheet calculated the voltage drop along the main line as 4.3 + 7.9 or 12.2 V or 5.3 %, and is within the acceptable range, once more confirming the previous results. If a conductor size of 31 mm<sup>2</sup> were substituted in the spreadsheet, the voltage drop would be calculated as 13.6 V (or 5.9 %), the same as the results obtained previously, using the equations presented on p. 72.

Note that by also using a 35 mm<sup>2</sup> conductor for the branch circuit, the voltage drop at the end of that circuit is only (0.6 + 7.9)/230 or 3.7 %. A smaller conductor could be used. Replacing “35 mm<sup>2</sup>” in the

**Table 30. Calculating the loading along the main line shown in Fig. 144.**

Pole no.	Distance (km)	Demand (kW)	Loading (kW km)
24	0.600	0.20	0.120
23	0.575	0.25	0.144
22	0.550	0.10	0.055
21	0.525	0.30	0.158
20	0.500	0.05	0.025
19	0.475	0.45	0.214
18	0.450	0.00	0.000
17	0.425	0.25	0.106
16	0.400	0.30	0.120
15	0.375	0.00	0.000
14	0.350	0.40	0.140
13	0.325	0.00	0.000
12	0.300	0.00	0.000
11	0.275	0.00	0.000
10	0.250	1.00	0.250
9	0.225	0.05	0.011
8	0.200	0.10	0.020
7	0.175	0.00	0.000
6	0.150	0.15	0.023
5	0.125	0.05	0.006
4	0.100	0.20	0.020
3	0.075	0.10	0.008
2	0.050	0.15	0.008
1	0.025	0.30	0.008
<b>Totals:</b>		<b>4.40</b>	<b>1.43</b>

module for the branch circuit with smaller values, one could go down to using a 4 mm<sup>2</sup> aluminum conductor for that circuit before the voltage drop between the source and end of the branch circuit attains the 6 % limit. Therefore, rather than using 35 mm<sup>2</sup> conductor for this branch, a long service drop of perhaps 5 mm<sup>2</sup> aluminum conductor could be used.

**Notes on the use of spreadsheet for more involved circuits:**

Note that two very similar spreadsheet modules are used in Fig. 145: one for end segments and one for source segments. Any distribution circuit can be divided into segments and one of the two modules can be used to analyze each, depending on the type of segment. Here, a segment can either be a length of line between the power supply and the first junction, a length of line between any two consecutive junctions, or a length between any end of the line and the preceding junction.\* For calculating purposes, two different types of segments are used: source or intermediate segments (including the first two types of segments defined above) and end segments (including the last type of segment defined above).

Any radial circuit can be analyzed using these two modules. For example, for the line presented in the lower right of Fig. 146, the five modules for the end segments and the three modules for the intermediate and source segments would be interrelated as shown in this figure.

Note that the differences between the two modules are only in two cells:

- The first entry in the “Main demand” column is zero in the source or intermediate module.
- The sum of the currents leaving any source or intermediate segments (i.e., the sum of the currents calculated at the beginning of the follow-on segment or segments) is placed at the top of the “Current” column (see the Source segment module in Fig. 145 as an example).

***For the proper use of spreadsheets, all cells must be properly interrelated. Otherwise errors are easily introduced. In preparing spreadsheets, results should always be checked for reasonableness against results obtained using other methods.***

---

\* A “junction” here is defined as a point where line conditions change, usually a point where the line splits up, although a point where the conductor size changes would also qualify.

**Fig. 145. A detailed analysis of the line shown in Fig. 144 verifies that a 35 mm<sup>2</sup> conductor is suitable to keep voltage drop to within 6 %.**

<b>Basic specifications:</b>		
Voltage at end =	230 V	
Frequency =	50 Hz	
Power factor =	0.9	

<b>Main line, pole 10 - 24</b>	<b>Ending segment</b>							
	(1) Span no.	(2) Demand (kW) Spurs	(3) Demand (kW) Main	(4) Voltage (V)	(5) Current (A)	(6) Length (km)	(7) Volt drop (V)	(8) Power loss (kW)
<b>Line specifications:</b>	24	0.200	0.200	230.0	1.0	0.025	0.0	0.000
Conductor size =	23	0.250	0.450	230.0	2.2	0.025	0.1	0.000
Equiv. separation =	22	0.100	0.550	230.0	2.7	0.025	0.1	0.000
Resistance =	21	0.300	0.850	230.0	4.1	0.025	0.2	0.001
Reactance =	20	0.050	0.900	230.0	4.3	0.025	0.2	0.001
	19	0.450	1.350	230.0	6.5	0.025	0.3	0.002
	18	0.000	1.350	230.0	6.5	0.025	0.3	0.002
	17	0.250	1.600	230.0	7.7	0.025	0.3	0.003
	16	0.300	1.900	230.0	9.2	0.025	0.4	0.004
	15	0.000	1.900	230.0	9.2	0.025	0.4	0.004
	14	0.400	2.300	230.0	11.1	0.025	0.5	0.005
	13	0.000	2.300	230.0	11.1	0.025	0.5	0.005
	12	0.000	2.300	230.0	11.1	0.025	0.5	0.005
	11	0.000	2.300	230.0	11.1	0.025	0.5	0.005
	<b>TOTALS:</b>		<b>2.30</b>	<b>230.0</b>	<b>11.1</b>	<b>0.350</b>	<b>4.3</b>	<b>0.036</b>

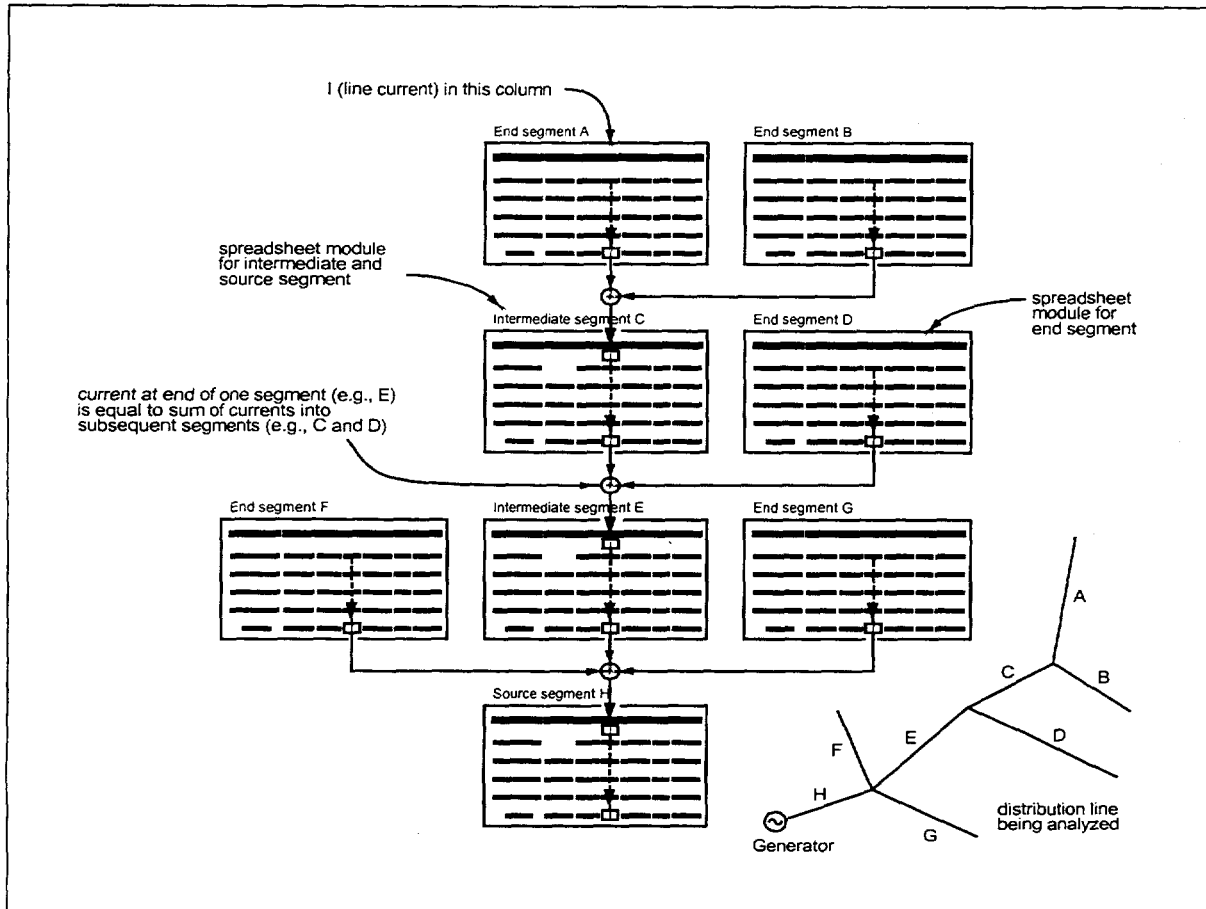
  

<b>Branch line, pole 10,25-30</b>	<b>End segment</b>							
	Span no.	Demand (kW) Spurs	Demand (kW) Main	Voltage (V)	Current (A)	Length (km)	Volt drop (V)	Power loss (kW)
<b>Line specifications:</b>	30	0.150	0.150	230.0	0.7	0.025	0.0	0.000
Conductor size =	29	0.200	0.350	230.0	1.7	0.025	0.1	0.000
Equiv. separation =	28	0.050	0.400	230.0	1.9	0.025	0.1	0.000
Resistance =	27	0.100	0.500	230.0	2.4	0.025	0.1	0.000
Reactance =	26	0.100	0.600	230.0	2.9	0.025	0.1	0.000
	25	0.300	0.900	230.0	4.3	0.025	0.2	0.001
	<b>TOTALS:</b>		<b>0.90</b>	<b>230.0</b>	<b>4.3</b>	<b>0.150</b>	<b>0.6</b>	<b>0.002</b>

<b>Main line, pole 1-10</b>	<b>Source segment</b>							
	Span no.	Demand (kW) Spurs	Demand (kW) Main	Voltage (V)	Current (A)	Length (km)	Volt drop (V)	Power loss (kW)
<b>Line specifications:</b>	10	0.100		230.0	15.5	0.025	0.7	0.011
Conductor size =	9	0.050	0.050	230.0	16.2	0.025	0.7	0.011
Equiv. separation =	8	0.100	0.150	230.0	16.7	0.025	0.7	0.012
Resistance =	7	0.000	0.150	230.0	16.7	0.025	0.7	0.012
Reactance =	6	0.100	0.250	230.0	17.1	0.025	0.8	0.012
	5	0.050	0.300	230.0	17.4	0.025	0.8	0.013
	4	0.200	0.500	230.0	18.4	0.025	0.8	0.014
	3	0.100	0.600	230.0	18.8	0.025	0.8	0.015
	2	0.150	0.750	230.0	19.6	0.025	0.9	0.016
	1	0.300	1.050	230.0	21.0	0.025	0.9	0.019
	<b>TOTALS:</b>		<b>1.05</b>	<b>230.0</b>	<b>21.0</b>	<b>0.250</b>	<b>7.9</b>	<b>0.134</b>

**Fig. 146. Illustration of how a series of spreadsheet modules can be used to analyze a more involved distribution system.**





## Appendix 8. Sag tables for multiplex conductor

Below are sag tables prepared for duplex and triplex aluminum conductor with a bare (neutral) ACSR messenger used in a "light loading district" in the U.S. as defined by the NESC (wind loading of  $440 \text{ N/m}^2$ ). The safety factor is defined as follows:

- **Initial unloaded condition (initial sag):** When the conductor is initially strung and is carrying no load, the tension shall not exceed 35 % of the ultimate strength of the conductor at 16 °C.
- **Final unloaded condition (final sag):** When the conductor has been subjected to assumed wind loading over a period of time, it receives a permanent stretch. When this condition is reached, the tension in the conductor without loading shall not exceed 25 % of ultimate strength of the conductor at 16 °C.

Furthermore, when the conductor is loaded to its assumed wind loading, the tension shall not exceed 60 % of the ultimate strength of the conductor at -1 °C (loaded condition).

Note the following trends:

- For the short and long spans of a specific duplex (or triplex) conductor, the tensions are roughly the same. This means that a greater sag is associated with the longer span (as determined by the equation for sag).
- For a specific span and specific size conductor, the tension for both duplex and triplex is the same because the same size messenger is used. However, the associated sags are greater for triplex because the weight of that bundle of conductors is greater for the the equivalent size duplex.
- For a specific span of duplex (or triplex) conductor, the sag is the same independent of the size of the duplex (or triplex) conductors used. This is because the weight of the conductor bundle and its ultimate tension are both proportional to conductor area. As the weight of the conductor bundle increases, the ultimate tension increases proportionately and their ratio ( $w_c/T$ ), which appears in the sag equation, remains unchanged.

For sagging new cable, the shaded sections of the tables below are the ones of immediate importance.

These tables have been provided by a conductor manufacture specifically for the conductor and operating conditions described above. Conductor manufacturers would be able to provide charts for other size and type conductors that are to be used in a particular situation.

# DUPLEX

## #6 (13 mm<sup>2</sup>) ACSR Duplex (113 kg/km)

Sag at initial sag (m)

Span (m)	Conductor temperature					
	-1°C	10°C	16°C	25°C	32°C	40°C
40	0.14	0.16	0.16	0.18	0.20	0.23
70	0.42	0.47	0.50	0.53	0.57	0.60

Tension at initial sag (kg)

Conductor temperature						
-1°C	10°C	16°C	25°C	32°C	40°C	
165	145	140	123	110	100	
163	148	139	130	121	116	

Sag at final sag (m)

Span (m)	Conductor temperature					
	-1°C	10°C	16°C	25°C	32°C	40°C
40	0.16	0.20	0.23	0.27	0.31	0.38
70	0.49	0.58	0.63	0.73	0.80	0.88

Tension at final sag (kg)

Conductor temperature						
-1°C	10°C	16°C	25°C	32°C	40°C	
137	115	100	83	72	60	
140	119.0	110	95	86	78	

## #4 (21 mm<sup>2</sup>) ACSR Duplex (172 kg/km)

Sag at initial sag (m)

Span (m)	Conductor temperature					
	-1°C	10°C	16°C	25°C	32°C	40°C
40	0.15	0.17	0.17	0.19	0.20	0.23
70	0.44	0.49	0.52	0.56	0.60	0.62

Tension at initial sag (kg)

Conductor temperature						
-1°C	10°C	16°C	25°C	32°C	40°C	
236	207	203	179	169	148	
237	216	201	189	176	169	

Sag at final sag (m)

Span (m)	Conductor temperature					
	-1°C	10°C	16°C	25°C	32°C	40°C
40	0.17	0.21	0.23	0.28	0.33	0.39
70	0.52	0.61	0.66	0.76	0.84	0.92

Tension at final sag (kg)

Conductor temperature						
-1°C	10°C	16°C	25°C	32°C	40°C	
198	165	148	121	105	88	
204	173	159	138	125	114	

## #2 (34 mm<sup>2</sup>) ACSR Duplex (265 kg/km)

Sag at initial sag (m)

Span (m)	Conductor temperature					
	-1°C	10°C	16°C	25°C	32°C	40°C
40	0.14	0.15	0.16	0.18	0.20	0.22
70	0.41	0.45	0.48	0.53	0.58	0.63

Tension at initial sag (kg)

Conductor temperature						
-1°C	10°C	16°C	25°C	32°C	40°C	
392	351	330	293	265	236	
395	357	338	306	282	257	

Sag at final sag (m)

Span (m)	Conductor temperature					
	-1°C	10°C	16°C	25°C	32°C	40°C
40	0.16	0.20	0.22	0.27	0.32	0.38
70	0.50	0.59	0.64	0.74	0.82	0.91

Tension at final sag (kg)

Conductor temperature						
-1°C	10°C	16°C	25°C	32°C	40°C	
323	264	237	194	165	140	
323	274	252	219	198	179	

## #1/0 (53 mm<sup>2</sup>) ACSR Duplex (424 kg/km)

Sag at initial sag (m)

Span (m)	Conductor temperature					
	-1°C	10°C	16°C	25°C	32°C	40°C
40	0.14	0.16	0.17	0.19	0.21	0.24
70	0.43	0.48	0.50	0.56	0.61	0.67

Tension at initial sag (kg)

Conductor temperature						
-1°C	10°C	16°C	25°C	32°C	40°C	
602	536	502	440	400	354	
606	548	516	465	4428	390	

Sag at final sag (m)

Span (m)	Conductor temperature					
	-1°C	10°C	16°C	25°C	32°C	40°C
40	0.17	0.21	0.23	0.29	0.34	0.39
70	0.52	0.62	0.67	0.77	0.85	0.94

Tension at final sag (kg)

Conductor temperature						
-1°C	10°C	16°C	25°C	32°C	40°C	
497	404	361	295	253	215	
497	4421	388	338	306	277	

# TRIPLEX

## #6 (13 mm<sup>2</sup>) ACSR Triplex (172 kg/km)

**Sag at initial sag (m)**

Span (m)	Conductor temperature					
	-1°C	10°C	16°C	25°C	32°C	40°C
40	0.21	0.24	0.25	0.28	0.31	0.34
70	0.65	0.71	0.76	0.81	0.87	0.91

**Tension at initial sag (kg)**

Conductor temperature						
-1°C	10°C	16°C	25°C	32°C	40°C	
165	145	140	123	110	100	
163	148	139	130	121	116	

**Sag at final sag (m)**

Span (m)	Conductor temperature					
	-1°C	10°C	16°C	25°C	32°C	40°C
40	0.25	0.30	0.34	0.41	0.48	0.57
70	0.75	0.89	0.96	1.11	1.23	1.35

**Tension at final sag (kg)**

Conductor temperature						
-1°C	10°C	16°C	25°C	32°C	40°C	
137	115	100	83	72	60	
140	119	110	95	86	78	

## #4 (21 mm<sup>2</sup>) ACSR Triplex (252 kg/km)

**Sag at initial sag (m)**

Span (m)	Conductor temperature					
	-1°C	10°C	16°C	25°C	32°C	40°C
40	0.21	0.24	0.25	0.28	0.30	0.34
70	0.65	0.71	0.76	0.81	0.87	0.91

**Tension at initial sag (kg)**

Conductor temperature						
-1°C	10°C	16°C	25°C	32°C	40°C	
236	207	203	179	169	148	
237	216	201	189	176	169	

**Sag at final sag (m)**

Span (m)	Conductor temperature					
	-1°C	10°C	16°C	25°C	32°C	40°C
40	0.25	0.30	0.34	0.41	0.48	0.57
70	0.75	0.89	0.97	1.11	1.23	1.35

**Tension at final sag (kg)**

Conductor temperature						
-1°C	10°C	16°C	25°C	32°C	40°C	
198	165	148	121	105	88	
204	173	159	138	125	114	

## #2 (34 mm<sup>2</sup>) ACSR Triplex (397 kg/km)

Sag at initial sag (m)

Span (m)	Conductor temperature					
	-1°C	10°C	16°C	25°C	32°C	40°C
40	0.20	0.23	0.24	0.27	0.30	0.34
70	0.62	0.68	0.72	0.79	0.86	0.95

Tension at initial sag (kg)

Conductor temperature						
-1°C	10°C	16°C	25°C	32°C	40°C	
392	351	330	293	265	236	
395	357	338	306	282	257	

Sag at final sag (m)

Span (m)	Conductor temperature					
	-1°C	10°C	16°C	25°C	32°C	40°C
40	0.25	0.30	0.34	0.41	0.48	0.57
70	0.75	0.89	0.96	1.11	1.23	1.36

Tension at final sag (kg)

Conductor temperature						
-1°C	10°C	16°C	25°C	32°C	40°C	
323	264	237	194	165	140	
323	274	252	219	198	179	

## #1/0 (53 mm<sup>2</sup>) ACSR Triplex (640 kg/km)

Sag at initial sag (m)

Span (m)	Conductor temperature					
	-1°C	10°C	16°C	25°C	32°C	40°C
40	0.21	0.24	0.25	0.28	0.31	0.34
70	0.65	0.71	0.75	0.81	0.87	0.93

Tension at initial sag (kg)

Conductor temperature						
-1°C	10°C	16°C	25°C	32°C	40°C	
605	543	512	459	419	378	
603	550	525	483	453	423	

Sag at final sag (m)

Span (m)	Conductor temperature					
	-1°C	10°C	16°C	25°C	32°C	40°C
40	0.26	0.31	0.34	0.40	0.44	0.50
70	0.79	0.89	0.95	1.04	1.12	1.20

Tension at final sag (kg)

Conductor temperature						
-1°C	10°C	16°C	25°C	32°C	40°C	
497	415	379	324	289	258	
497	439	414	376	351	328	



## **Appendix 9. Areas for further inquiry**

In the process of preparing this manual, questions were raised to which there seemed no clear response. Some of these questions have been listed below. It is hoped that this annotated listing might serve to draw information from others with experience in these areas. Alternatively, it might serve as topics for further research. If readers have information that addresses any of these points, we would appreciate it if it could be forwarded to the address below so that this information can be shared with others:

Allen R. Inversin  
NRECA - International Programs  
4301 Wilson Boulevard  
Arlington, VA 22203-1860

Fax: 703-907-5532  
Email: allen.inversin@nreca.org

### **Pole treatment**

Poles can be the most costly component of a mini-grid. Wood poles rely on a renewable resource, can be locally produced, and have numerous useful characteristics. The principal drawback is short life due to decay and insect damage. What can be done to increase its life and the attractiveness of this option? What useful techniques can be developed that could increase their life? In some areas, pole butts are painted with bituminous paints to offer protection when poles are set in earth in an area open to the elements. How effective is this "treatment" (i.e., a comparison of with and without)? Against what does it protect (decay, insect damage, etc.)? What about soaking the butts of poles in used automotive sump oil? Is this an effective treatment against something? Under what circumstances is it effective? Can its effectiveness be proved? What other simple treatment options have been documented?

### **Metal Poles**

Poles are generally the costliest single components of a mini-grid and even costlier when life-cycle costs are considered. Local wooden poles are inexpensive or free, if available, but without treatment, which is difficult to effectively achieve on a small scale, they must usually be frequently replaced. Concrete poles can be locally produced but require suitable quality control of both materials and production and are difficult to transport and set. The most appropriate alternative could be fabricated sectionalized steel poles, which are easy to handle and set and have a long life if galvanized or properly painted. Chapter VIII provides a couple of ideas for such poles. An intervention that could prove of great advantage to those implementing mini-grids would be one or more simple yet durable metal pole designs, including a description of construction techniques. Such a design should also include information on the proper depth for setting different size poles, maximum lateral poletop force that can be handled before a pole buckles and collapses, and typical cost and manufacturing requirements. Designs for locally fabricated poletop hardware suitable for metal poles would also be useful.

### **Strength of smaller diameter poles**

Poles are sized by using the ultimate fiber stress of the species under consideration and calculating the strength required at the ground line to withstand a given bending moment due primarily to the lateral force of the wind and to line tension when there is a deviation in the direction of the line. For poles used with mini-grids, poles with reduced girth are necessary. Are the values of ultimate fiber stress over the

cross-section of the pole which are typically used for utility-grade poles reduced for smaller poles because of different physical make-up of the smaller than standard diameter poles (less mature wood, larger percentage of sap to heartwood, etc.)?

### Optimum setting depth

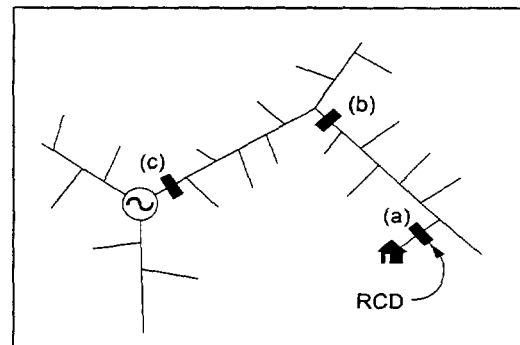
As explained in the section on setting poles (p. 102), to maximize line-to-ground clearance for a pole of given length, it is necessary that pole length not be “wasted” by setting it too deeply. A rule of thumb is available for the setting depth for the size of poles commonly used by electric utilities. Is this rule of thumb also valid for poles of small diameter that would be encountered in mini-grids? If not, what new rule of thumb can be derived for such poles? Mathematical or empirical relationships could be useful.

### Measuring the effectiveness of the electrical ground

If a ground electrode is installed to achieve a specific purpose (e.g., increase personnel safety), one must be ensured that it indeed does serve that purpose. To function properly, ground resistance must be suitably low and there must be a method for verifying its value. Typically, specialized equipment is utilized to measure grounding resistance. More recently, a range of solid-state devices has been developed that facilitate this task. Such devices are not readily available to those working in rural areas overseas. Under these circumstances, are there other approaches that can be used to measure ground resistance, one that might rely on basic principles and use basic equipment (a genset, multi-tester, etc.)?

### Magnitude of leakage currents

In Western households, RCDs are commonly used in individual homes to protect consumers from body currents that could prove hazardous (placement (a) in Fig. 147). However, widespread use of these devices can prove costly in those cases where minimal housewiring systems are sufficient to meet small lighting loads of most consumers and cost is a major deterrent to their receiving a connection. In these cases, and when the specific distribution circuit supplying a number of consumers is not grounded, it is suggested in the chapter on protection (see Fig. 96, p. 139) that several homes can be protected with a single RCD (placement (b) or perhaps even (c) in Fig. 147). This approach should detect fault currents through faulty electrical equipment to the consumer ground and open the circuit, thereby removing the threat of shock before it is touched by individuals. Leakage distributed along this entire length of line may prevent a threshold current from being set at a level sufficiently low where the RCD will be triggered solely by fault current going through an individual. Is it possible to categorize leakage current levels (what are they caused by and what is their magnitude) in typical situations? If this were possible, one would be in a better position to locate and size RCD to minimize cost yet ensure effective protection to people.



**Fig. 147. How effective are different placements of RCDs for detecting specific fault conditions along a branch circuit?**



- 
- <sup>1</sup> Mark Hayton, personal correspondence, Bandung, Indonesia, 23 April 1993.
- <sup>2</sup> Louineau, Dicko, Fraenkel, Barlow, and Bokalders, "Rural lighting, A guide for development workers", Intermediate Technology Publications Ltd. (103-105 Southampton Row, London WC1B 4HH, U.K.), 1994.
- <sup>3</sup> D.C. Pritchard, "Lighting", Fifth edition, Longman, 1995 (ISBN 0-582-23422-0).
- <sup>4</sup> Theodore Baumeister (ed), "Standard Handbook for Mechanical Engineers", Seventh Edition, McGraw-Hill Book Company, New York, 1967.
- <sup>5</sup> Allen Inversin, "New designs for rural electrification, Private-sector experiences in Nepal", NRECA, Arlington, VA, 1994.
- <sup>6</sup> "Primer on woodpole production program", Power Use Development Division, Cooperative Services Department, NEA, Philippines.
- <sup>7</sup> A.K. Lahiry, "Manual of a mini treating plant for waterborne preservative treatment of timber and bamboo", Rural Electrification Board (Dhaka, Bangladesh), Paper No. IRG/WP 99-40130 published in 1999 by The International Research Group on Wood Preservation (SE-100 44 Stockholm, Sweden)
- <sup>8</sup> "Building in hot climates. A selection of overseas building notes", issued by the Building Research Establishment, Distribution Unit (Garston, Watford, WD2 7JR, England).
- <sup>9</sup> "Series 4, High pressure sap displacement treatment", Second Revision, Forest Products Research and Development Institute, Laguna, Philippines, December 1997.
- <sup>10</sup> "Report on design, construction and testing of RCC electric poles", DCS (prepared for ITDG/Nepal), Butwal, Nepal. June 1995.
- <sup>11</sup> "Final report on development of a portable device for manufacturing pre-stressed concrete power poles for microhydro schemes", prepared by DCS for the UNDP's Rural Energy Development Programme, Butwal, Nepal. November 1998.
- <sup>12</sup> "REC specifications and construction standards", Rural Electrification Corporation, Ltd., New Delhi, 1994.
- <sup>13</sup> J.F. Seiler, "Effect of depth of embedment on pole stability", Wood Preserving News (American Wood-Preservers' Association), November 1932 (available at the USDA Library in Beltsville, MD).
- <sup>14</sup> "Getting down to earth", Biddle Instruments (510 Township Line Road, Blue Bell, PA 19422, Phone: 215-646-9200), 1990.
- <sup>15</sup> Dale L. Nafziger, "A synopsis of domestic sector impacts at the Andhi Khola hydel and rural electrification project and their implications for future Butwal Power Company rural electrification planning", Butwal Power Company (P.O. Box 126, Kathmandu, Nepal), 1994.
- <sup>16</sup> Development and Consulting Services can be reached through P.O. Box 126, Kathmandu and Sustainable Control Systems, which been field testing its unit in Peru, can be reached through 4 Charleston House, Peel Street, Nottingham NG1 4GN, England (or, on the Internet, at <http://www.scs-www.com>).







The World Bank

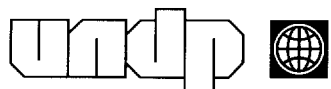
1818 H Street, NW

Washington, DC 20433 USA

Tel.: 1.202.458.2321 Fax.: 1.202.522.3018

Internet: [www.esmap.org](http://www.esmap.org)

Email: [esmap@worldbank.org](mailto:esmap@worldbank.org)



A joint UNDP/World Bank Programme